

SURGISKILL



DENTAL INSTRUMENTS CATALOGUE
www.surgi-skill.com

For over 30 years SURGI SKILL has been devoted to providing its customers with the highest quality Electrosurgical, Surgical, Dental, Beauty, Podiatry, Veterinary and Single Use Instruments.

SURGI SKILL is committed to provide you with the highest quality instruments. We are the original equipment manufacturer (OEM) for all above mention instruments.

Our production depth covers thousands of instruments ranging from the typical instruments use in clinic to sophisticated instruments required during surgeries. We deem, however, pertinent to submit further that the range and scope of our production activities is not limited to our production literature. We can produce instruments even if not depicted in our online catalogues. We receive samples, photos or references from the world-renowned companies catalogues.

QUALITY/ INNOVATION

At SURGI SKILL the quality is set in motion through motivated specifications planning by trained technical persons. The computer added design and imaging provide visual instruments a set configuration. This simplifies each aspect of instruments manufacturing.

QUALITY CERTIFICATIONS:

We are ISO 9001:2015, ISO 13485:2016, CE MARK, CGMP approved.

COMMITMENT:

Our commitment is to meet the changing needs of healthcare systems and to lead the industry by providing quality surgical instruments and dental instruments at competitive price.

We understand the diverse needs of our customers and know that quality along with delivery time are the most important and common requirements of our customers from both segments. This Realization allows us to serve our customers in the most efficient and cost effective manners.

Wish you all the Best.

SURGI SKILL Team

50



Extracting Forceps, American Pattern
 Zahnzangen, Amerikanische Form
 Daviers, forme américaine
 Forceps de extracción, forma americana
 Pinze per estrozione, forma americana

Page 01 to 15

51



Extracting forceps, English pattern
 Zahnzangen, Englische Form
 Daviers, forme anglaise
 Fórceps dentales, forma inglesa
 Pinze per estrazione, forma inglese

Page 16 - 38

52



Root Elevators
 Wurzelheber
 Elévateurs á racines
 Botadores para raíces
 Leve per radici

Page 40 to 54

53



Bone Files
 Bone-Dateien
 Archivos de huesos
 Fichiers d'os
 Bone Files

Page 55 to 56

54



Dental Probes
 Zahnsonden
 Sondas dentales
 Sondes dentaires
 Sonde dentali

Page 57 to 58

55



Enamel Instruments
 Emaille-Instrumente
 Instrumentos de esmalte
 Instruments d'émail
 Strumenti per smalto

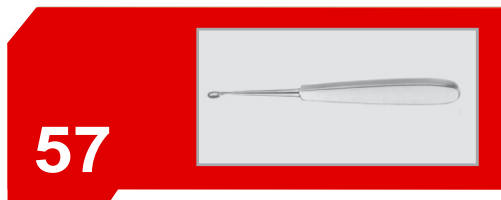
Page 59 to 62

56



Dental Scalers
 Zahnsteinentferner
 Escaladores dentales
 Scalers dentaires
 Scaler dentali

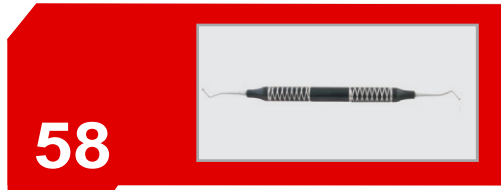
Page 63 to 78



57

**Bone Crettes
Knochenküretten
Curetas de hueso
Curettes osseuses
Curette d'ossa**

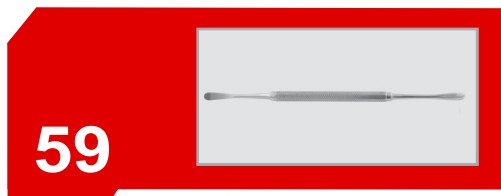
Page 79 to 84



58

**Excavators
Bagger
Excavadoras
Pelles
escavatori**

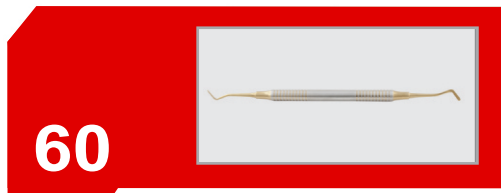
Page 85 to 89



59

**Wax Proclein
Wachs-Porzellan
cera Porcelana
Cire Porcelaine
Cera porcellana**

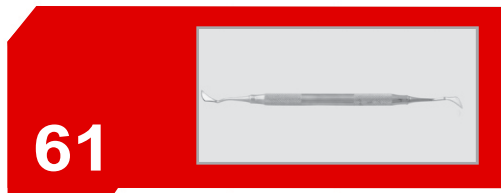
Page 90 to 94



60

**Filling Instruments
Füllungsinstrumente
Actos de llenado
Instruments de remplissage
Strumenti di riempimento**

Page 95 to 105



61

**Gingivectomy Knives
Gingivektomie Messer
Cuchillos de gingivectomía
Couteaux de gingivectomie
Coltelli per gengivectomia**

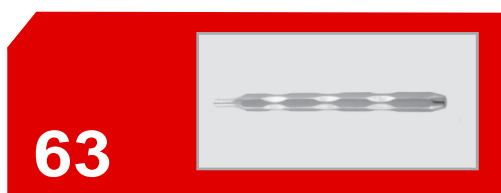
Page 106 to 107



62

**Cement Spatulas
Zementspatel
Espátulas de cemento
Spatules de ciment
Spatole di cemento**

Page 108 to 112



63

**Mouth Mirrors
Mundspiegel
Espejos bucales
Bouche Miroirs
Bocca specchi**

Page 113 to 115

64



Amalgam Instruments
Amalgam Instrumente
Instrumentos de amalgama
Instruments Amalgam
Strumenti amalgama **Page 116 to 117**

65



Matrix Retainers
Matrix-Halterungen
Retenedores de matrices
Retenue de matrice
Matrix Retainers **Page 118 to 125**

66



Hemostatic Forceps
Arterienklemmen
Pinces hemostaticas
Pinzashemostaticas
Pinze emostatiche **Page 126 to 132**

67



Towel Clamps
Handtuchklammern
Abrazaderas de toalla
Pinces à serviettes
Morsetti per asciugamano **Page 133 to 134**

68



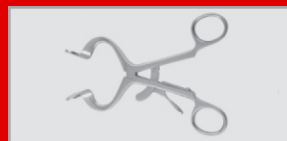
Needle Holders
Nadelhalter
Porte-aiguilles
Porta-agujcs
Port' aghi **Page 135 to 143**

69







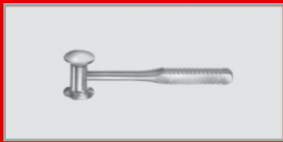


Retractors
Wundhaken
Ecarteurs
Separadores
Divaricatori **Page 144 to 148**

70



Mouth and Tongue
Mund und Zunge
Boca y la lengua
Bouche et langue
Bocca e la lingua **Page 149 to 152**

<p>71</p>		<p>Scissors Schere Tijeras Les ciseaux Forbici</p>	<p>Page 153 to 168</p>
<p>72</p>		<p>Micro Scissors Mikroschere Micro tijeras Micro-ciseaux Micro forbici</p>	<p>Page 169 to 170</p>
<p>73</p>		<p>Orthodontics Kieferorthopädie Ortodoncia Orthodontie Ortodonzia</p>	<p>Page 171 to 187</p>
<p>74</p>		<p>Bone Rongeurs Knochen Rongeur Rongeurs de hueso Os Rongeurs Bone Rongeurs</p>	<p>Page 188 to 190</p>
<p>75</p>		<p>Forceps Zange Fórceps Forceps forcipe</p>	<p>Page 191 to 198</p>
<p>76</p>		<p>Scalpel Handles Skalpellgriffe Manches de bistouris Mangos de Bisturías Manici per bisturi</p>	<p>Page 199 to 200</p>
<p>77</p>		<p>Mallets Schlägel Mazos Maillets Mallets</p>	<p>Page 201 to 203</p>

78



**Cassettes
Kassetten
Cassettes
Cassettes
cassette**

Page 204 to 207

79



**Cylinder cartridge syringe
Zylinder-Ampullenspritze
Seringue á ampoule cylindrique
Jeringo para cartucho ampollas
Siringe ampollare a cilindro**

Page 208 to 213

80



**Impression Trays
Abdrucklöffel
Porte empreintes
Cubetas para impresiones
Portaimpronte**

Page 214 to 225

81



**Articulators
Artikulatoren
Articuladores
Articulateurs
articolatori**

Page 226 to 227

82



**Holloware
Holloware
holloware
Platerie
Holloware**

Page 228 to 231

50

- EN** Extracting Forceps, American Pattern
- DE** Zahnzangen, Amerikanische Form
- ES** Daviers, forme américaine

Page 01 to 15

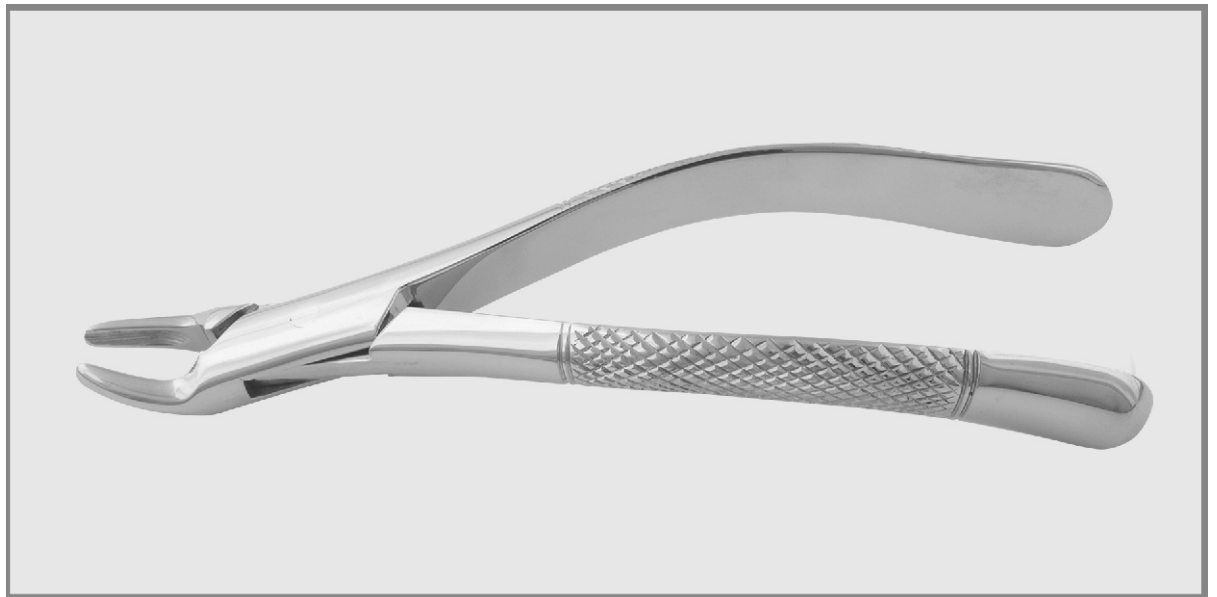
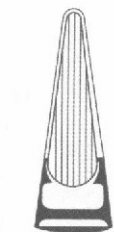
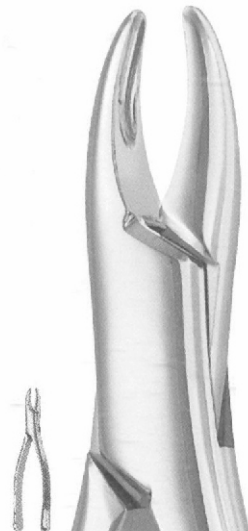




Fig. 1



SS-50-1001



HENAHAN
Fig. 1 A



SS-50-1002



Fig. 1 B



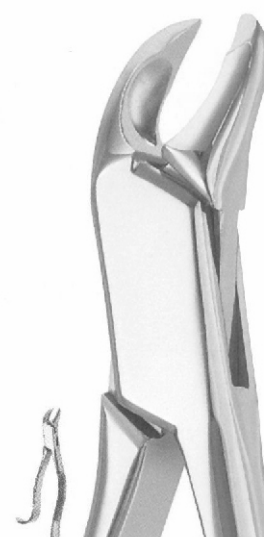
SS-50-1003



MILWAUKEE
Fig. 3



SS-50-1004



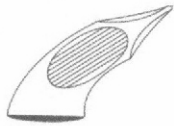
WOOD-WARD
Fig. 3 FH



SS-50-1005



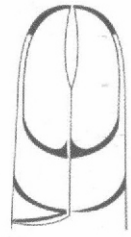
SS-50-1006



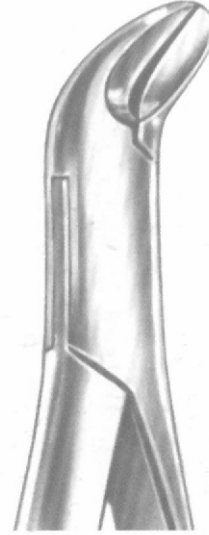
WOOD-WARD
Fig. 3 FS



SS-50-1007



PHYSICK
Fig. 5



SS-50-1008

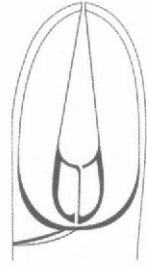


Fig. 6



SS-50-1009

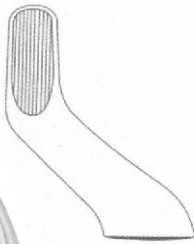


Fig . 10 H



SS-50-1010

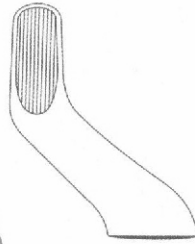
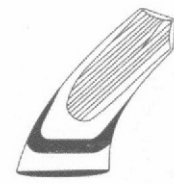


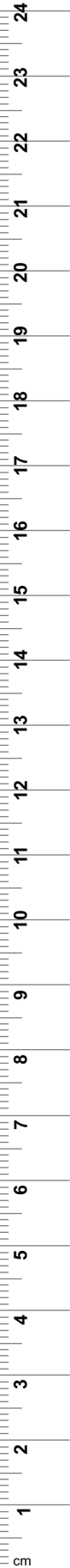
Fig . 10 S

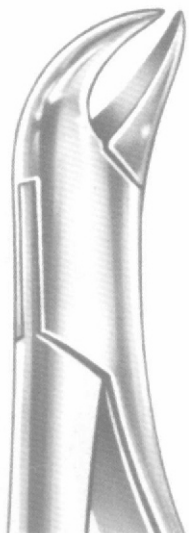


SS-50-1011

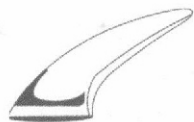


HARRIS
Fig . 15





HARRIS
Fig. 16



SS-50-1012



Fig. 16 S



SS-50-1013



Fig. 17



SS-50-1014



HARRIS
Fig. 18 L



SS-50-1015



HARRIS
Fig. 18 R



SS-50-1016



Fig. 23

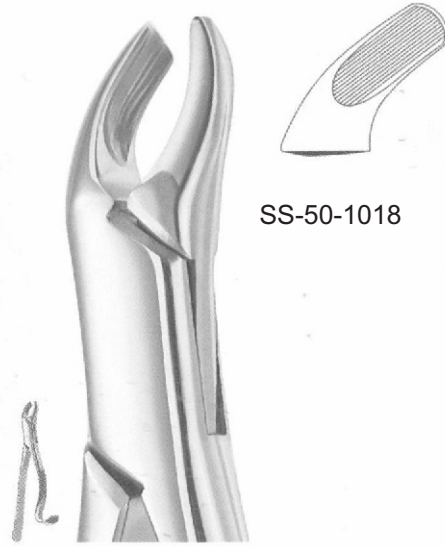


Fig. 24

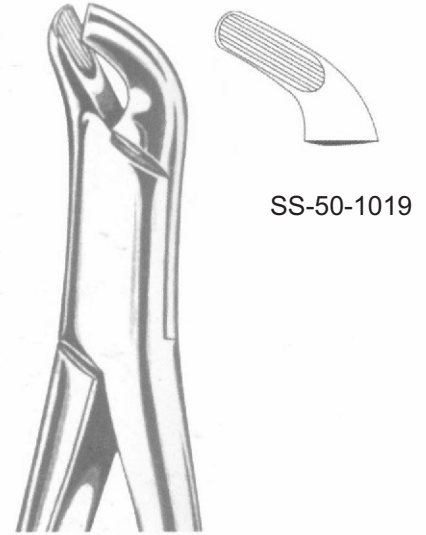


Fig. 27



PARMLY
Fig. 32



PARMLY
Fig. 32 A

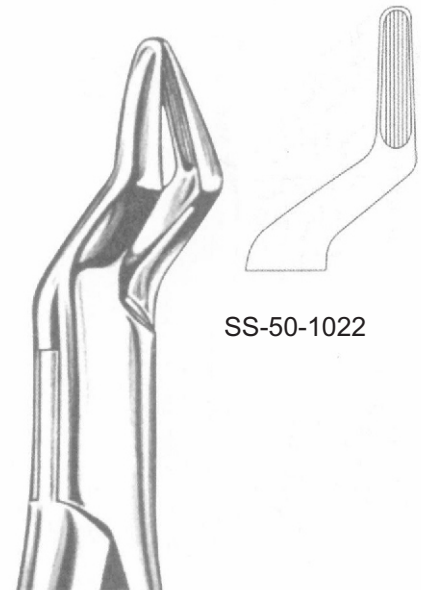
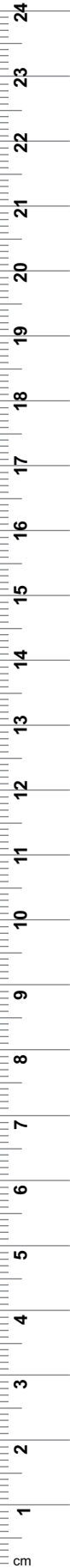


Fig. 35





SS-50-1023

Fig. 53 L



SS-50-1024

Fig. 53 R



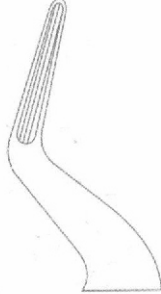
Fig. 62



SS-50-1025



Fig. 65



SS-50-1026



TOMES
Fig. 69



SS-50-1027



THOMAS
Fig. 85



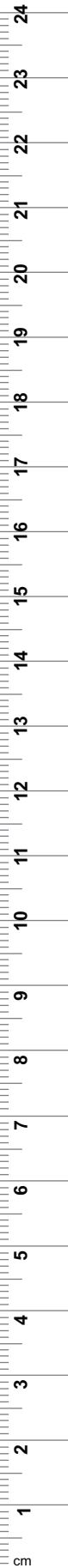
SS-50-1028



THOMAS
Fig. 85 A

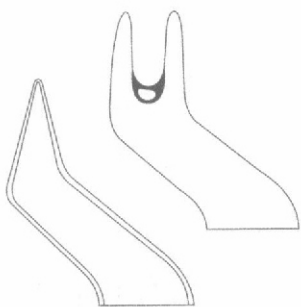


SS-50-1029





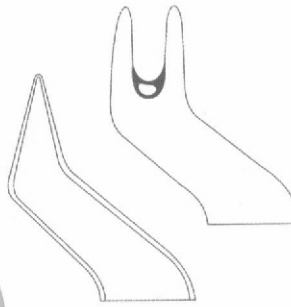
NEVIUS
Fig. 88 L



SS-50-1030



NEVIUS
Fig. 88 R



SS-50-1031



KELLS
Fig. 99 A



SS-50-1032



KELLS
Fig. 99 C



SS-50-1033



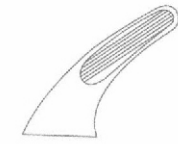
HULL
Fig. 101



SS-50-1034



Fig. 103



SS-50-1035



Fig. 10 H



SS-50-1036



Fig. 10 S



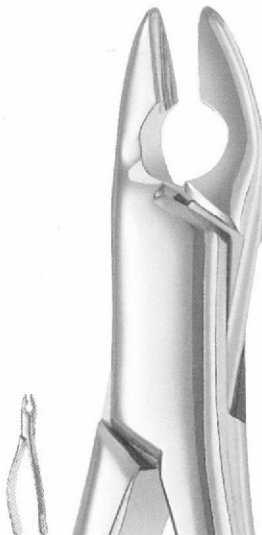
SS-50-1037



CRYER
Fig. 150



SS-50-1038



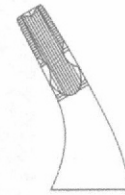
CRYER
Fig. 150 A



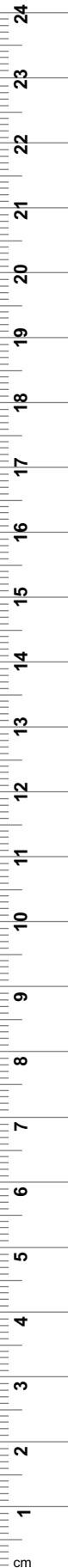
SS-50-1039



Fig. 150 X



SS-50-1040





SS-50-1041



SS-50-1042



SS-50-1043

Fig. 150 AB

Fig. 150 AS

CRYER
Fig. 150 S



CRYER
Fig. 151

SS-50-1044



CRYER
Fig. 151 A



SS-50-1045

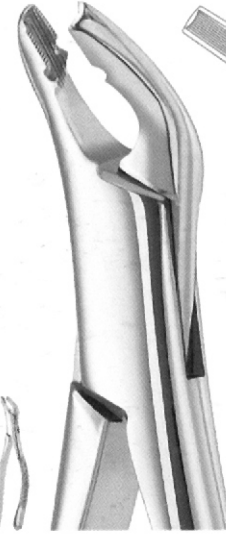
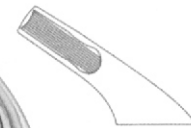


Fig. 151 X



SS-50-1046



CRYER
Fig. 151 AB

SS-50-1047

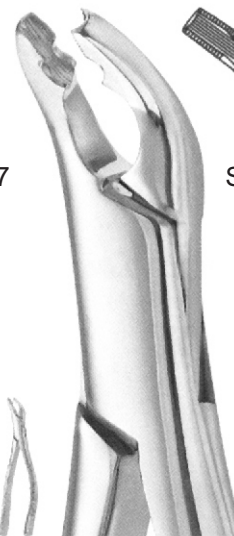
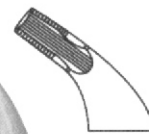


Fig. 151 AS

SS-50-1048



CRYER
Fig. 151 S

SS-50-1049

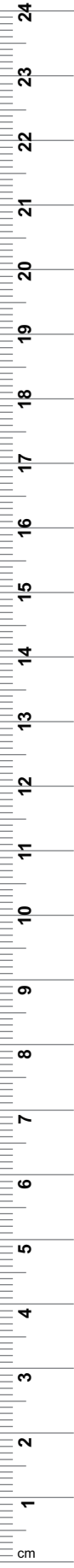




Fig. 286



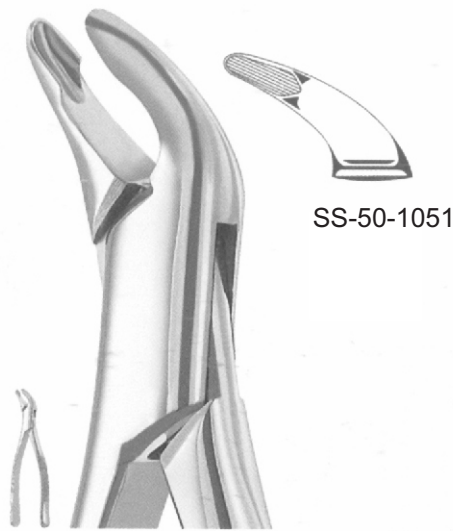
Fig. 288



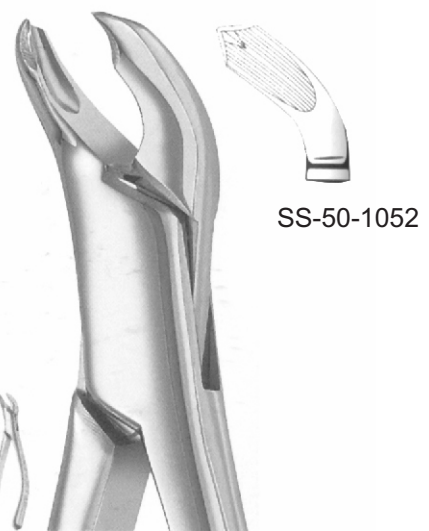
Fig. 287



Fig.201



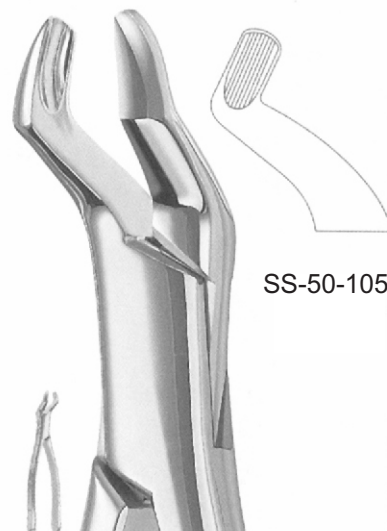
SS-50-1051



SS-50-1052



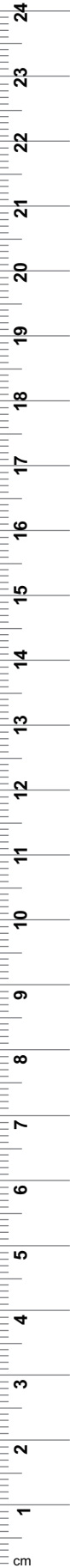
SS-50-1053



SS-50-1054



SS-50-1055



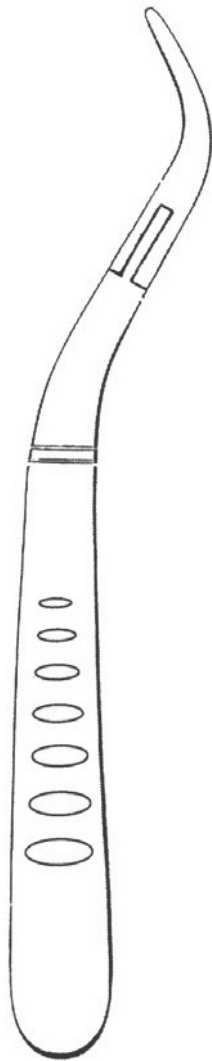


Fig.300



SS-50-1059

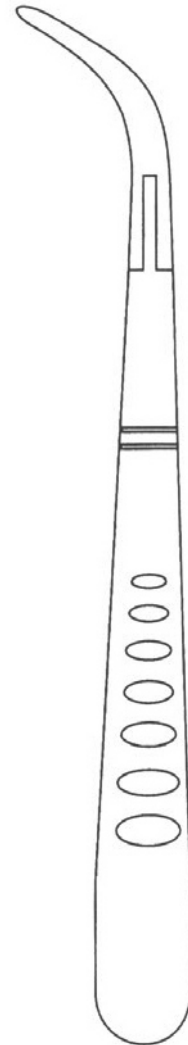
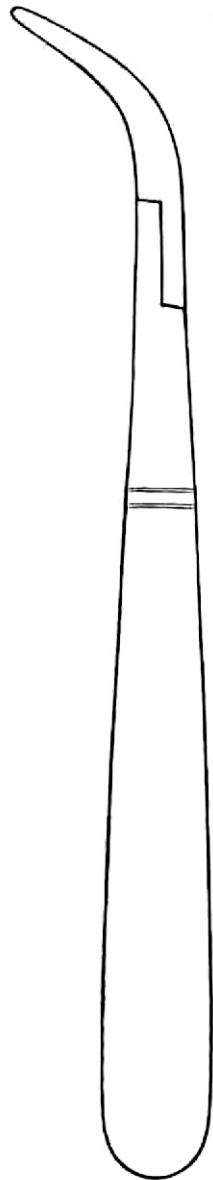


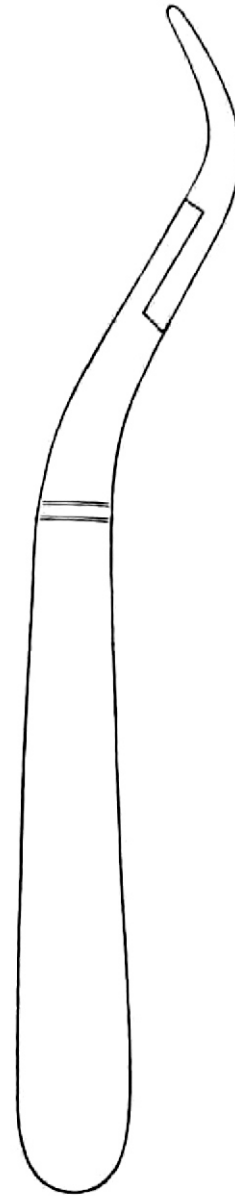
Fig.301



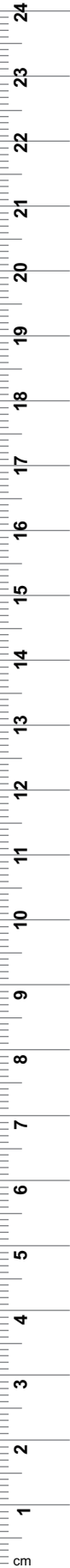
SS-50-1060



SS-50-1061
WITZEL
Fig.501



SS-50-1062
WITZEL
Fig.502





SS-50-1063

Fig. 17 SK



SS-50-1064

Fig. 23 SK



SS-50-1065

Fig. 150 Sk



SS-50-1066

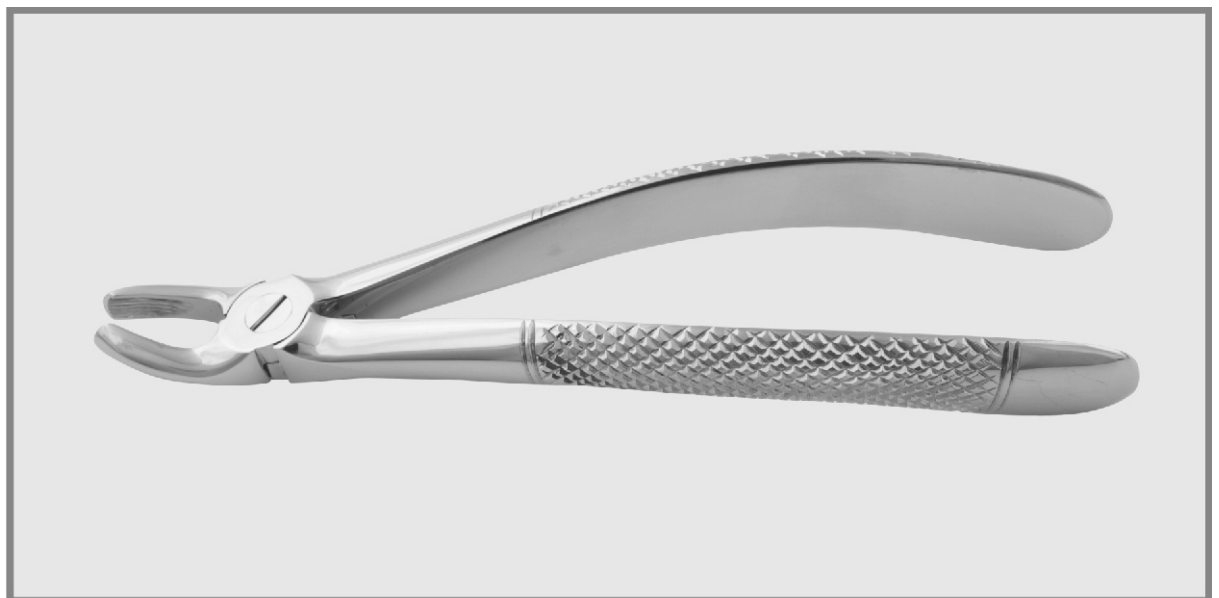
Fig. 151 Sk



51

- EN** Extracting forceps, English pattern
- DE** Zahnzangen, Englische Form
- ES** Daviers, forme anglaise

Page 16 - 38

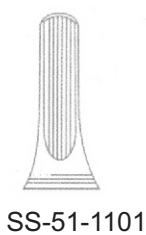


- EN —●— Extracting forceps, English pattern
- DE —●— Zahnzangen, Englische Form
- ES —●— Daviers, forme anglaise

EXTRACTING FORCEPS ENGLISH



Fig. 1



SS-51-1101

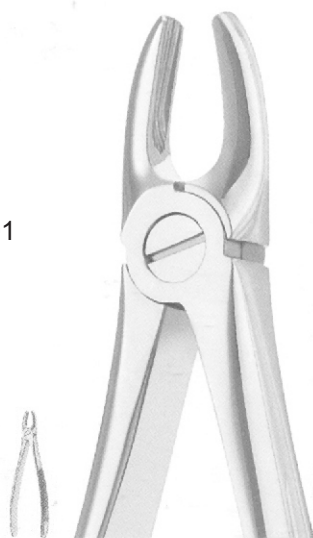
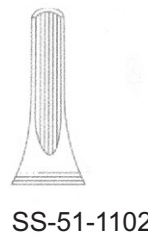


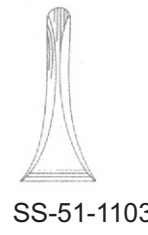
Fig. 2



SS-51-1102



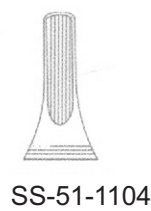
Fig. 3



SS-51-1103



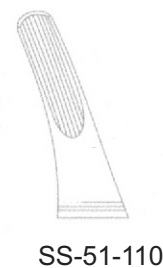
Fig. 4



SS-51-1104



Fig. 7



SS-51-1105

EXTRACTING FORCEPS ENGLISH



SS-51-1106

Fig. 8



Fig. 13



SS-51-1107



Fig. 17



SS-51-1108



Fig. 18



SS-51-1109



Fig. 18 A



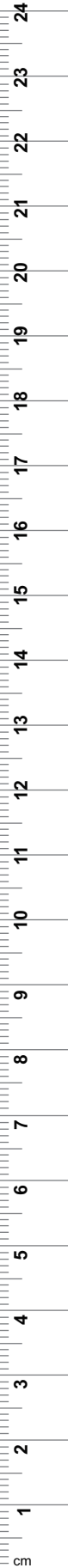
SS-51-1110



Fig. 19



SS-51-1111

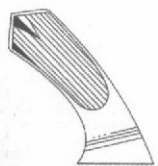


EN —•— Extracting forceps, English pattern
 DE —•— Zahnzangen, Englische Form
 ES —•— Davares, forme anglaise

EXTRACTING FORCEPS ENGLISH



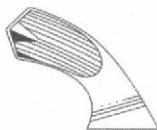
Fig. 20



SS-51-1112



Fig. 21



SS-51-1113



Fig. 22



SS-51-1114



Fig. 23



SS-51-1115



Fig. 24



SS-51-1116

EXTRACTING FORCEPS ENGLISH



Fig. 29

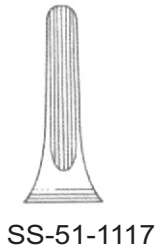


Fig. 29 N

SS-51-1118



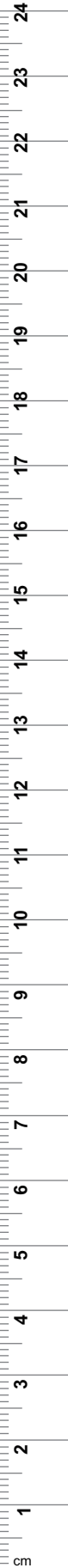
Fig. 30



Fig. 31



Fig. 32
SS-51-1121

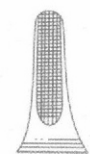


- EN —●— Extracting forceps, English pattern
- DE —●— Zahnzangen, Englische Form
- ES —●— Davares, forme anglaise

EXTRACTING FORCEPS ENGLISH



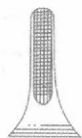
Fig. 33



SS-51-1122



Fig. 33 A



SS-51-1123



Fig. 33 C



SS-51-1124



Fig. 33 M



SS-51-1125



Fig. 33 W



SS-51-1126

EXTRACTING FORCEPS ENGLISH



SS-51-1127

Fig. 34



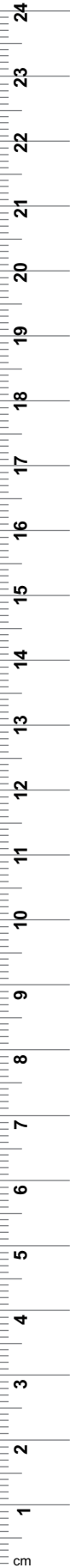
SS-51-1128

Fig. 35



SS-51-1129

Fig. 36



EN —●— Extracting forceps, English pattern
 DE —●— Zahnzangen, Englische Form
 ES —●— Daviers, forme anglaise

EXTRACTING FORCEPS ENGLISH



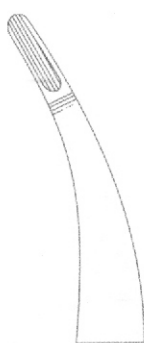
Fig. 41



SS-51-1130



Fig. 44



SS-51-1131



Fig. 44 F



SS-51-1132



Fig. 45



SS-51-1133



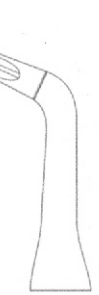
Fig. 45 F



SS-51-1134



Fig. 46 L

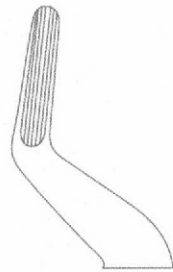


SS-51-1135

EXTRACTING FORCEPS ENGLISH



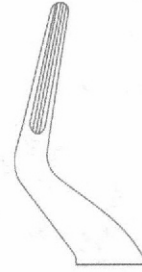
Fig. 51



SS-51-1136



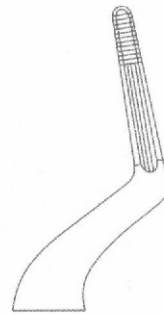
Fig. 51 A



SS-51-1137



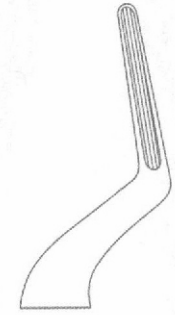
Fig. 51 C



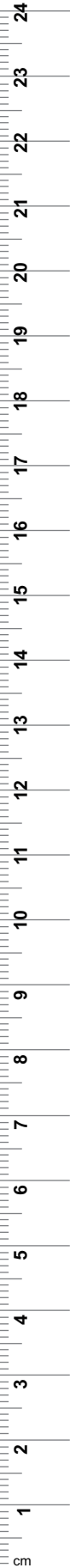
SS-51-1138



Fig. 51 L



SS-51-1139



EN —•— Extracting forceps, English pattern
 DE —•— Zahnzangen, Englische Form
 ES —•— Dabiers, forme anglaise

EXTRACTING FORCEPS ENGLISH



Fig. 51 M



Fig. 52

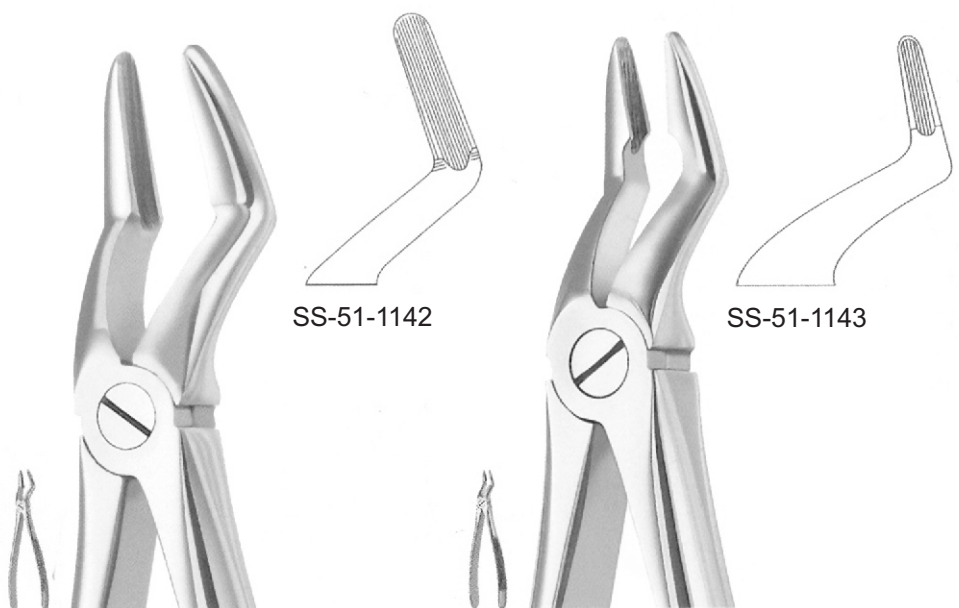


Fig. 52 A

Fig. 53

EXTRACTING FORCEPS ENGLISH



Fig. 55



SS-51-1144

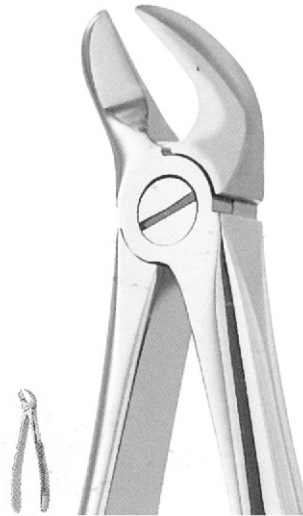
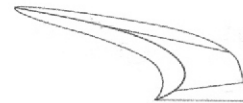
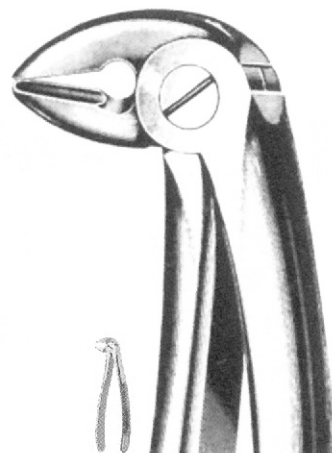


Fig. 56

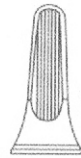


SS-51-1145



BUSCH
Fig. 59

breit
broad



SS-51-1146

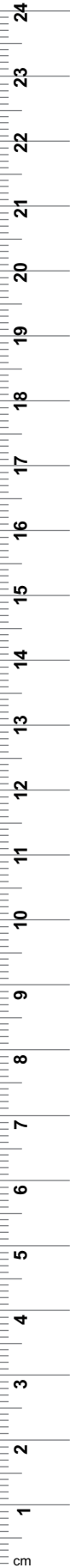


BUSCH
Fig. 60

schmal
narrow

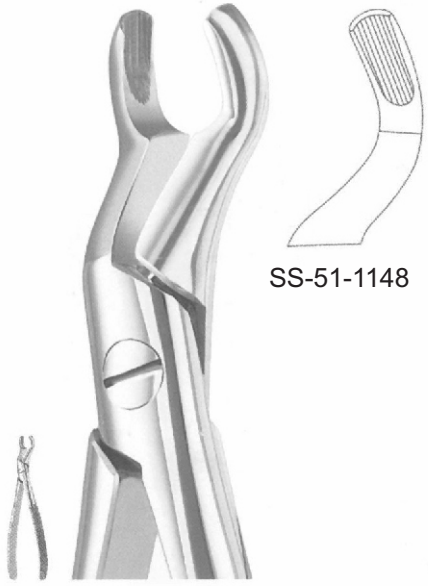


SS-51-1147



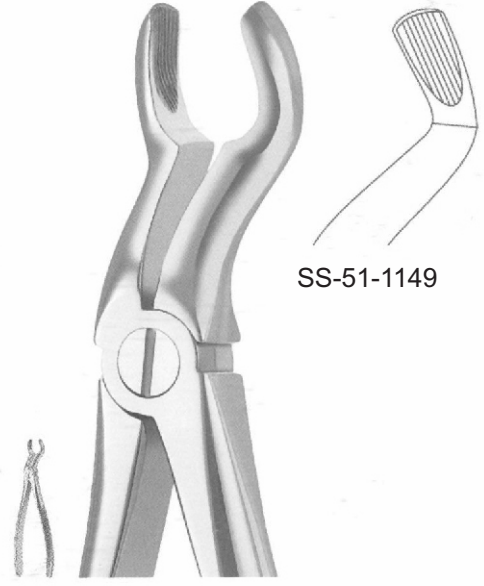
- EN —●— Extracting forceps, English pattern
- DE —●— Zahnzangen, Englische Form
- ES —●— Davares, forme anglaise

EXTRACTING FORCEPS ENGLISH



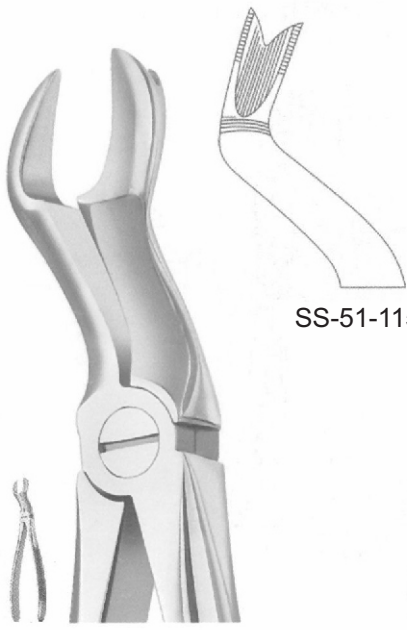
SS-51-1148

Fig. 67



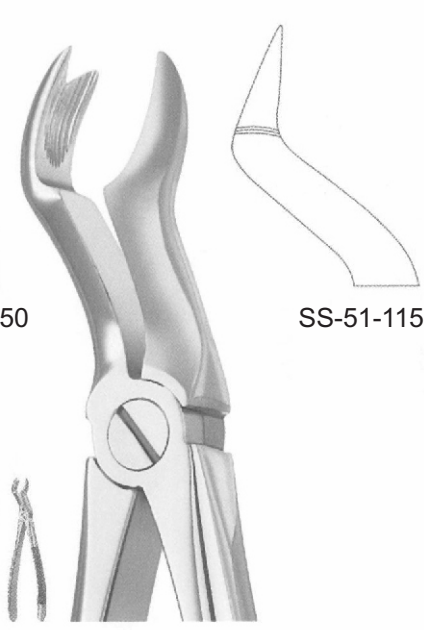
SS-51-1149

Fig. 67 A



SS-51-1150

Fig. 67 LX



SS-51-1151

Fig. 67 RX



SS-51-1152

RYDING
Fig. 68

EXTRACTING FORCEPS ENGLISH

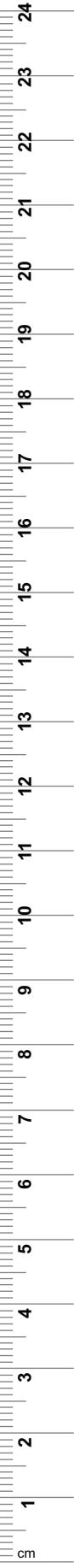


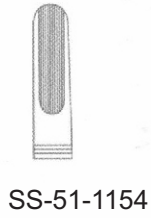
Fig. 73



SS-51-1153



Fig. 74



SS-51-1154

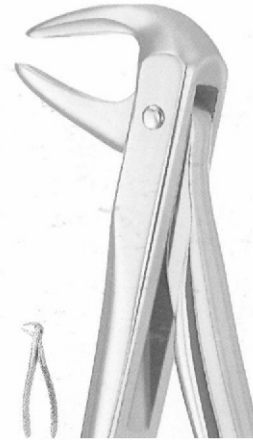
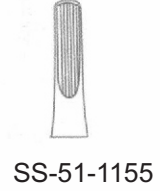


Fig. 74 M



SS-51-1155

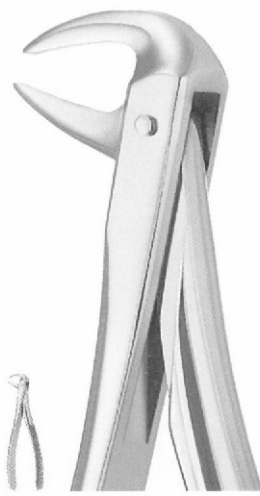
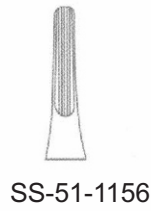


Fig. 74N



SS-51-1156



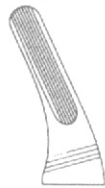
Fig. 75



SS-51-1157

- EN —●— Extracting forceps, English pattern
- DE —●— Zahnzangen, Englische Form
- ES —●— Dáviers, forme anglaise

EXTRACTING FORCEPS ENGLISH



SS-51-1158



SS-51-1159

LAWRENCE-READ
Fig. 76

LAWRENCE-READ
Fig. 76 N

EXTRACTING FORCEPS ENGLISH



Fig. 79



SS-51-1160

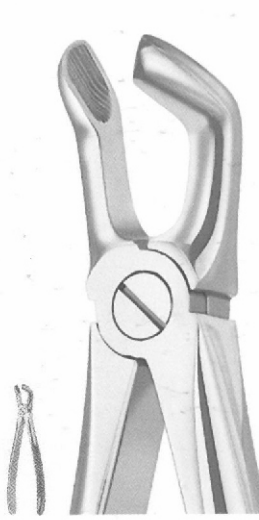
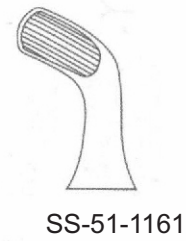


Fig. 79 A



SS-51-1161



Fig. 86 A



SS-51-1162

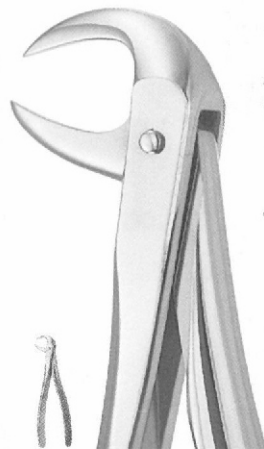
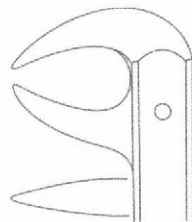


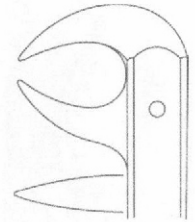
Fig. 86 B



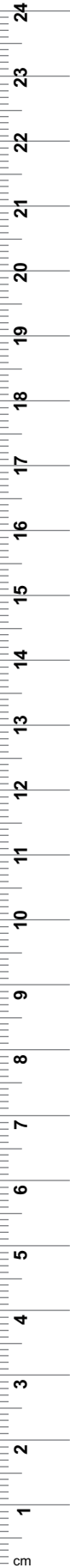
SS-51-1163



Fig. 86 C



SS-51-1164



EN —●— Extracting forceps, English pattern
 DE —●— Zahnzangen, Englische Form
 ES —●— Daviers, forme anglaise

EXTRACTING FORCEPS ENGLISH

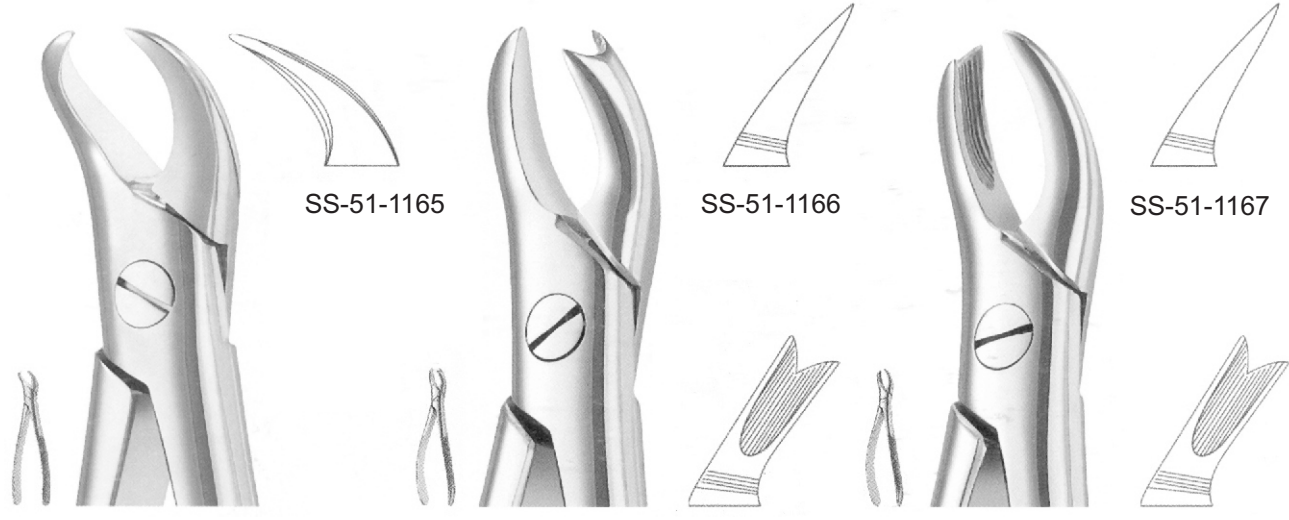


Fig. 87

Fig. 89

Fig. 90

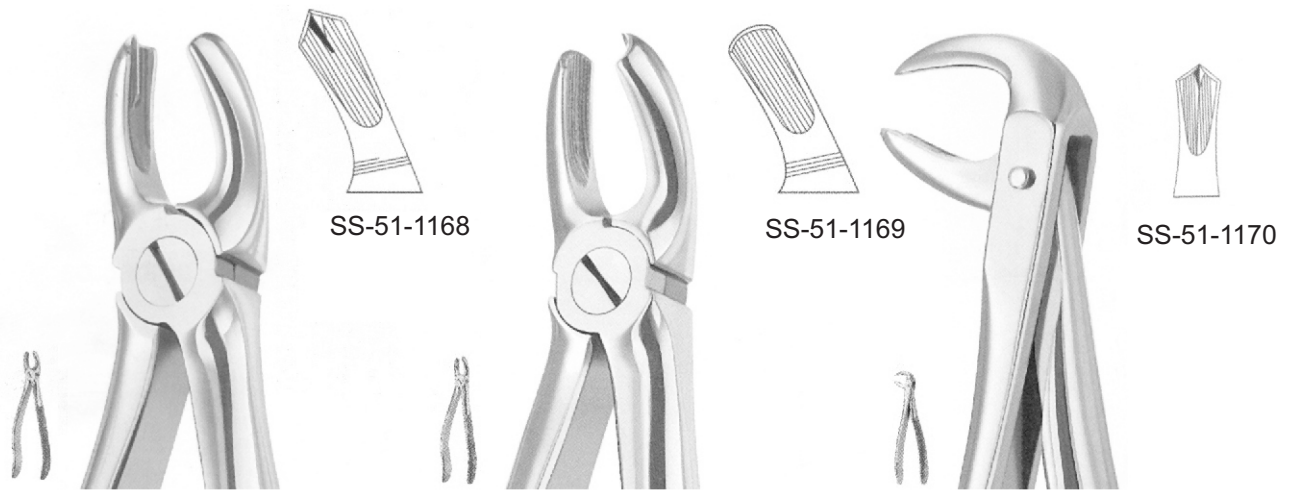


Fig. 94

Fig. 95

WOOD
Fig. 99

EXTRACTING FORCEPS ENGLISH

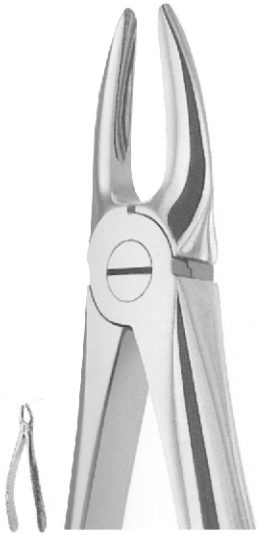
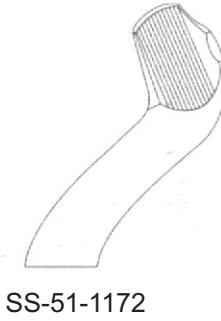


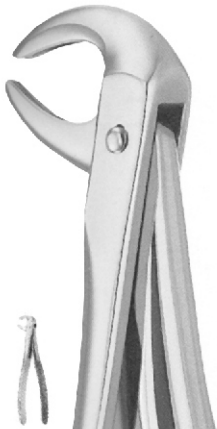
Fig. 113
SS-51-1171



OGDEN FELSCH
Fig. 121



GUY
Fig. 136
SS-51-1173



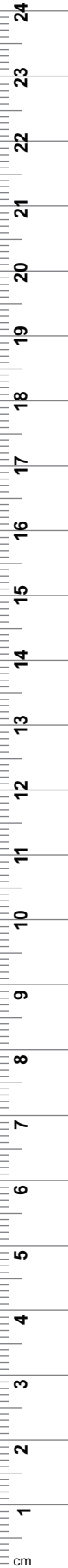
GUY
Fig. 137
SS-51-1174



Fig. 160
SS-51-1175



Fig. 162
SS-51-1176



- EN —●— Extracting forceps, English pattern
- DE —●— Zahnzangen, Englische Form
- ES —●— Davares, forme anglaise

EXTRACTING FORCEPS ENGLISH



SS-51-1177
Fig. 233



SS-51-1178



SS-51-1179
Fig. 235

EXTRACTING FORCEPS ENGLISH



MEAD
Fig. MD 1



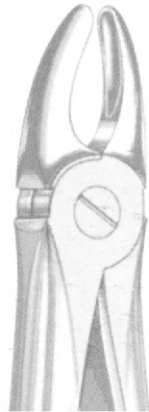
SS-51-1180



SS-51-1181



SS-51-1182



MEAD
Fig. MD 2



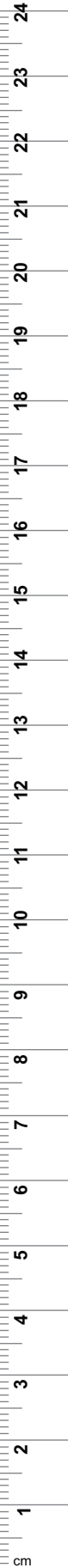
MEAD
Fig. MD 3



MEAD
Fig. MD 4



SS-51-1183

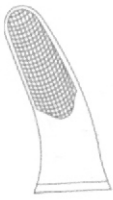
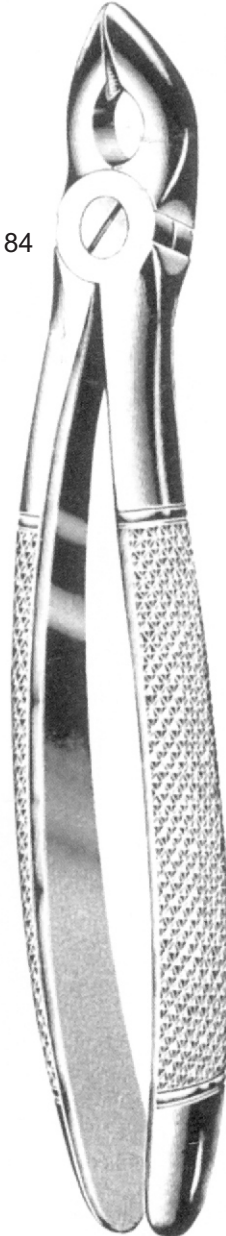


- EN —●— Extracting forceps, English pattern
- DE —●— Zahnzangen, Englische Form
- ES —●— Daviers, forme anglaise

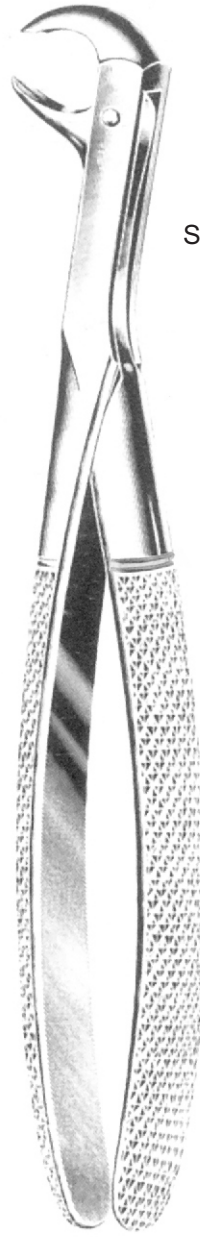
EXTRACTING FORCEPS ENGLISH



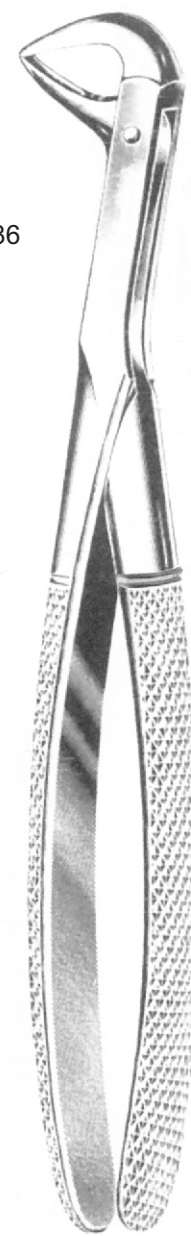
SS-51-1184



SS-51-1185



SS-51-1186



SS-51-1187

COHEN

COHEN

STIKSA

STIKSA

EXTRACTING FORCEPS ENGLISH

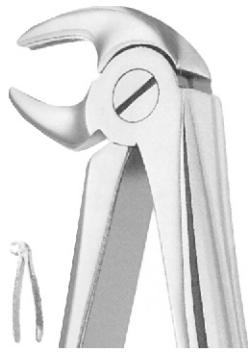
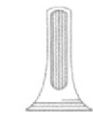


Fig. 13 S



SS-51-1188



Fig. 22 S



SS-51-1189



Fig. 29 S



SS-51-1190



Fig. 30 S



SS-51-1191



Fig. 33 S



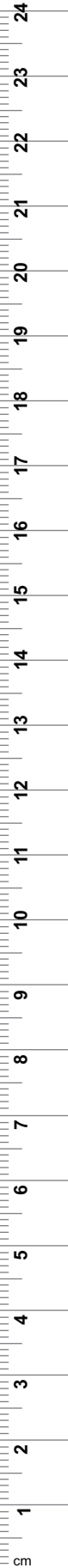
SS-51-1192



Fig. 37



SS-51-1193



- EN —•— Extracting forceps, English pattern
- DE —•— Zahnzangen, Englische Form
- ES —•— Davaers, forme anglaise

EXTRACTING FORCEPS ENGLISH



Fig. 38



Fig. 39

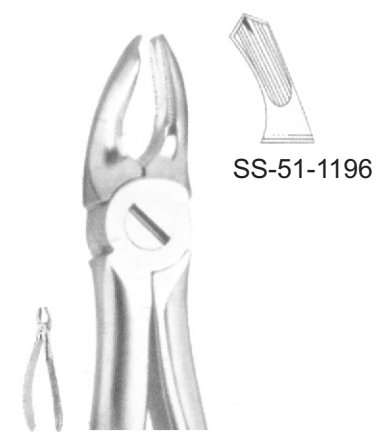


Fig. 39 A



Fig. 39 L



Fig. 39 R

EXTRACTING FORCEPS ENGLISH



Fig. 40



SS-51-1199



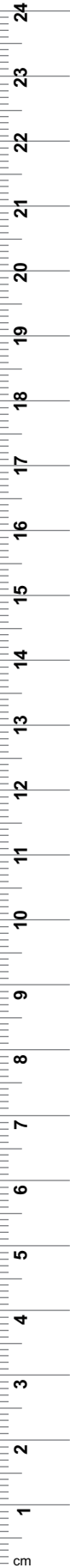
Fig. 51 S



SS-51-1200

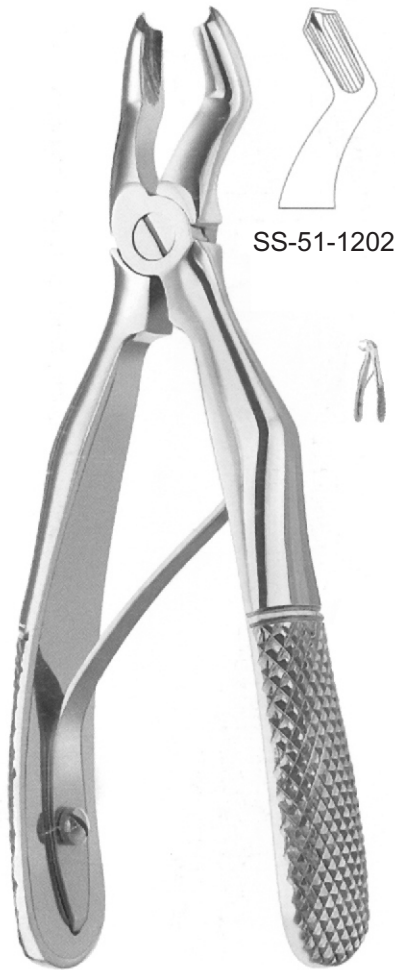


SS-51-1201
LAWRENCE-READ
Fig. 76 S



- EN —●— Extracting Forceps Kids, English Pattern
- DE —●— Zange-Zangen extrahieren, englisches Muster
- ES —●— Extracción de fórceps para niños, patrón inglés

EXTRACTING FORCEPS ENGLISH



KLEIN
Fig. 3



SS-51-1202



SS-51-1203

Fig. 5



SS-51-1204

Fig. 6



SS-51-1205

Fig. 7

EXTRACTING FORCEPS ENGLISH



SS-51-1206

KLEIN
Fig. 137



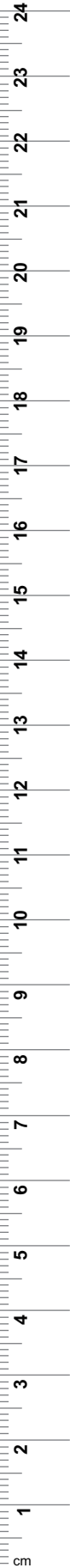
SS-51-1207

KLEIN
Fig. 139



SS-51-1208

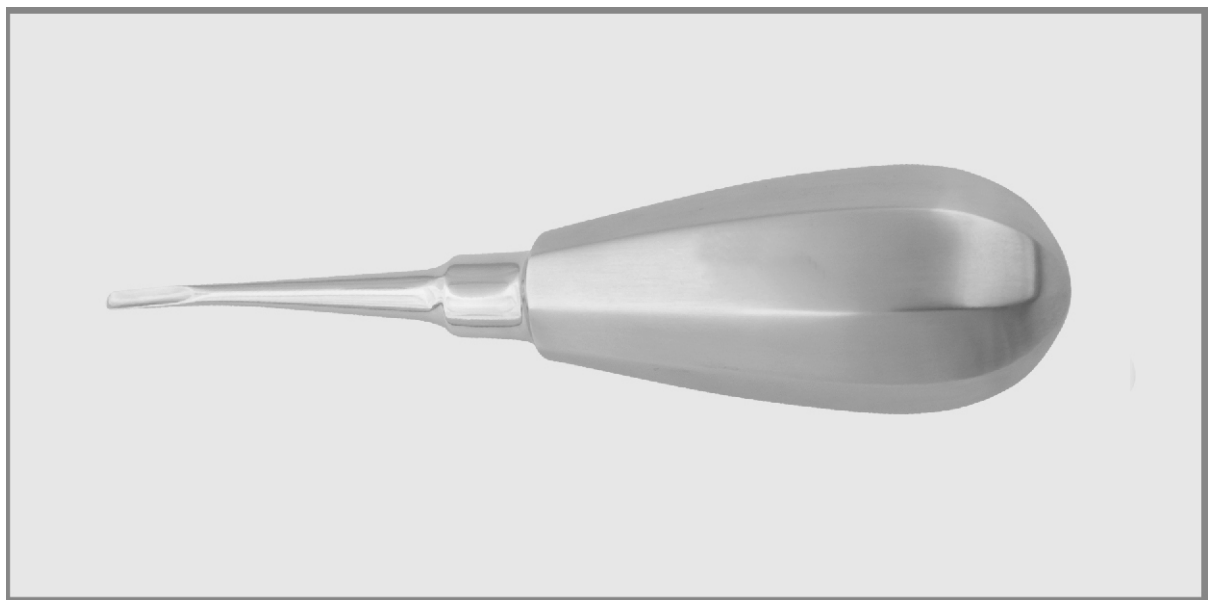
KLEIN
Fig. 51 S

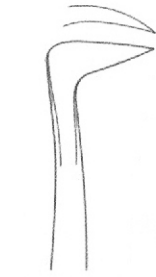


52

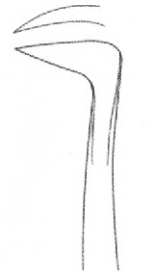
- EN** Root Elevators
- DE** Wurzelheber
- ES** Elevateurs á racines

Page 40 to 54





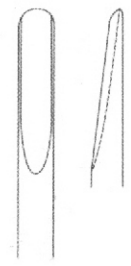
SS-52-1251
Fig. 1 L



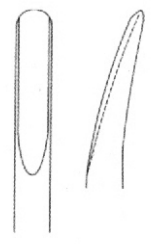
SS-52-1252
Fig. 1 R



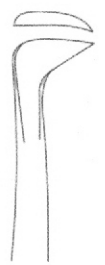
SALDIN
SS-52-1253
Fig. 2



SELDIN
SS-52-1254
Fig. 3



CRYER
SS-52-1255
Fig. 3 A



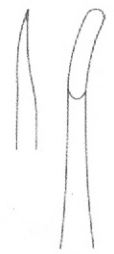
SELDIN
SS-52-1256
Fig. 4 L



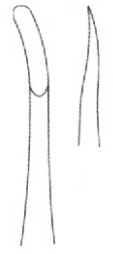
SELDIN
SS-52-1257
Fig. 4 R



CRANE
(COGSWELL)
SS-52-1258
Fig. 6



MILLER
SS-52-1259
Fig. 8



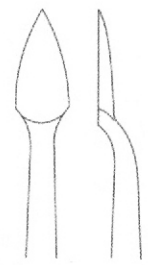
MILLER
SS-52-1260
Fig. 9



MILLER (Apexo)
SS-52-1261
Fig. 10



MILLER (Apexo)
SS-52-1262
Fig. 11



CRYER
SS-52-1263
Fig. 12



CRYER
 SS-52-1264
 Fig. 27



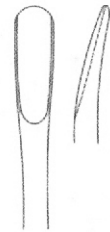
CRYER
 SS-52-1265
 Fig. 28



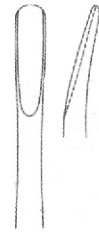
CRYER
 SS-52-1266
 Fig. 27 S



CRYER
 SS-52-1267
 Fig. 28 S



SELDIN
 SS-52-1268
 Fig. 34



SELDIN
 SS-52-1269
 Fig. 34 S



CRYER
 SS-52-1270
 Fig. 39



CRYER
 SS-52-1271
 Fig. 40



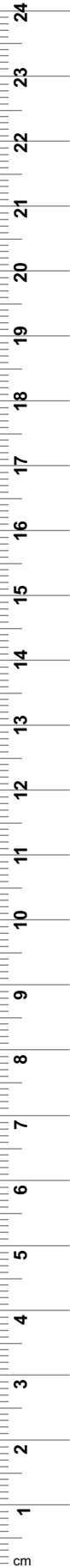
FLOHR
 SS-52-1272
 Fig. 46

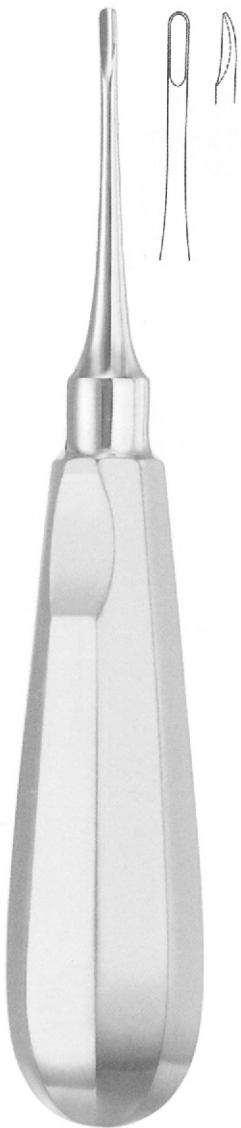


SS-52-1273
 Fig. 50

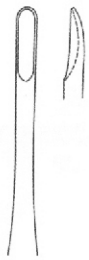


SS-52-1274
 Fig. 51

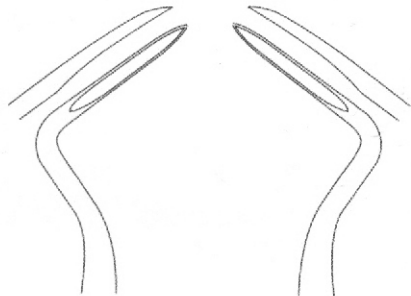




APICAL (Apexo)
 SS-52-1275
 Fig. 301



SS-52-1276
 Fig. 304



SS-52-1277
 Fig. 302

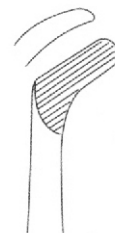
FLOHR
 SS-52-1278
 Fig. 303



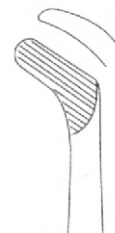
COLEMAN



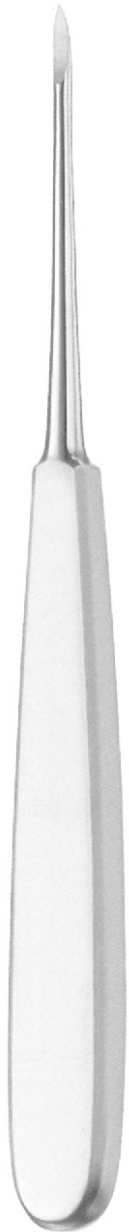
SS-52-1279
 Fig. 1



SS-52-1280
 Fig. 2 L



SS-52-1281
 Fig. 3 R



WARWICK JAMES
 SS-52-1282
 16 cm/6 1/4"



SS-52-1283
 Fig. 2 L



SS-52-1284
 Fig. 3 L



KOPP



SS-52-1285
 Fig. 1



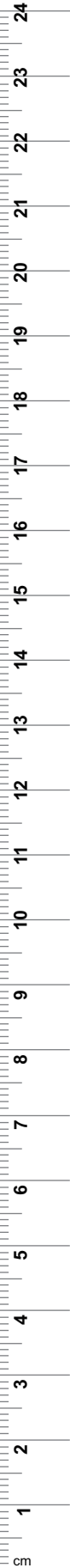
SS-52-1286
 Fig. 2



SS-52-1287
 Fig. 3



SS-52-1288
 Fig. 4





KOPP



SS-52-1289
Fig. 1



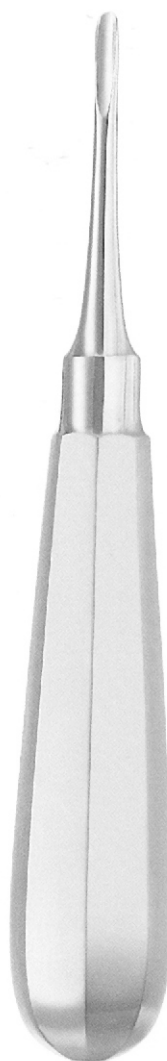
SS-52-1290
Fig. 2



SS-52-1291
Fig. 3



SS-52-1292
Fig. 4



FLOHR



SS-52-1293
Fig. 1



SS-52-1294
Fig. 2



SS-52-1295
Fig. 3



FRIEDMAN
SS-52-1296
Fig 1



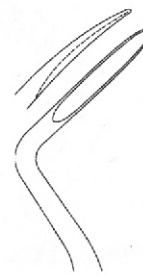
SS-52-1297
Fig. 2 L



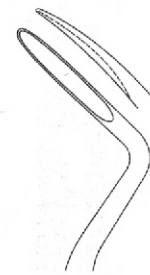
SS-52-1298
Fig. .3 R



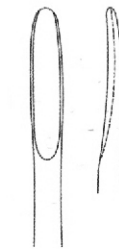
HYLIN
SS-52-1299
Fig. 1



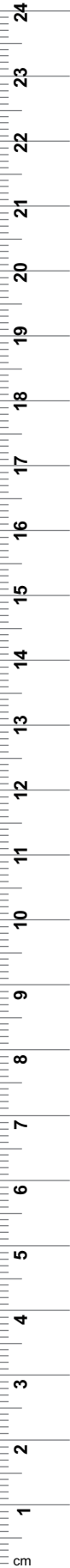
SS-52-1301
Fig. 3 L



SS-52-1302
Fig. 4 R



SS-52-1300
Fig. 2



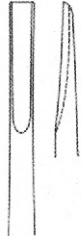


2 mm



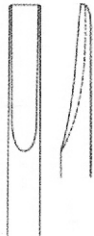
SS-52-1303
Fig.0

3 mm



BEIN
SS-52-1304
Fig. 1

4 mm



SS-52-1305
Fig. 2

2 mm



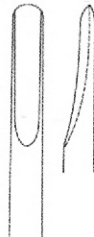
SS-52-1306
Fig. 0

3 mm



BEIN
SS-52-1307
Fig. 1

4 mm



SS-52-1308
Fig. 2

2 mm



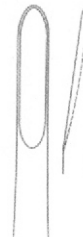
SS-52-1309
Fig. 0

3 mm



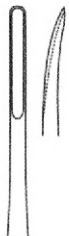
BEIN
SS-52-1310
Fig. 1

4 mm



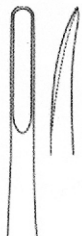
SS-52-1311
Fig. 2

2 mm



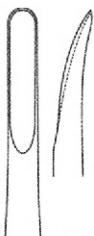
SS-52-1312
Fig. 0 A

3mm



BEIN
SS-52-1313
Fig. 1 A

4 mm



SS-52-1314
Fig.2 A

2 mm



SS-52-1315
Fig.0 A

3 mm

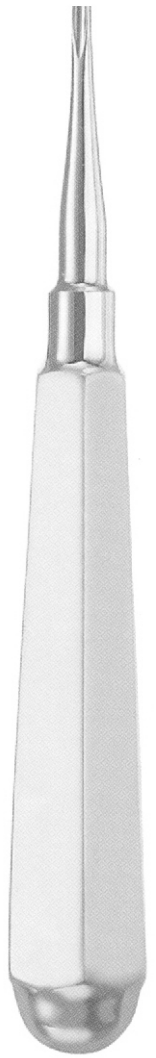
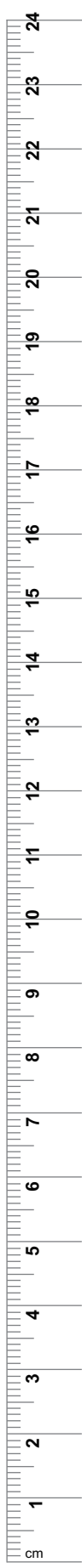


BEIN
SS-52-1316
Fig. 1 A

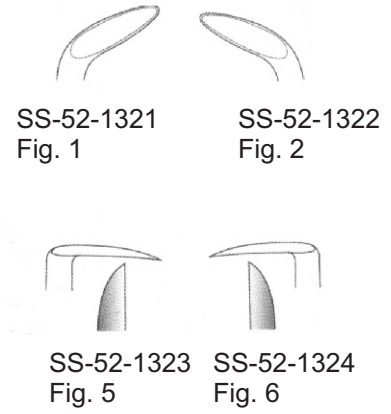
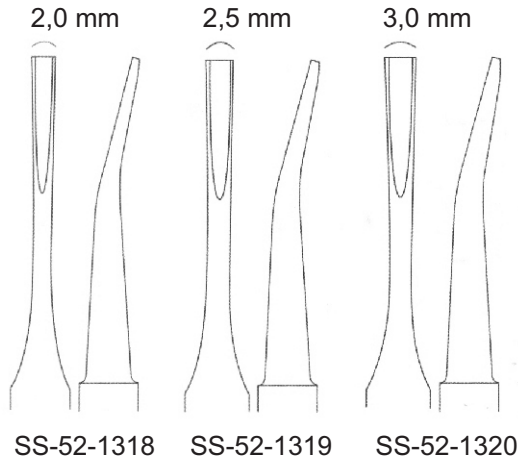
4 mm



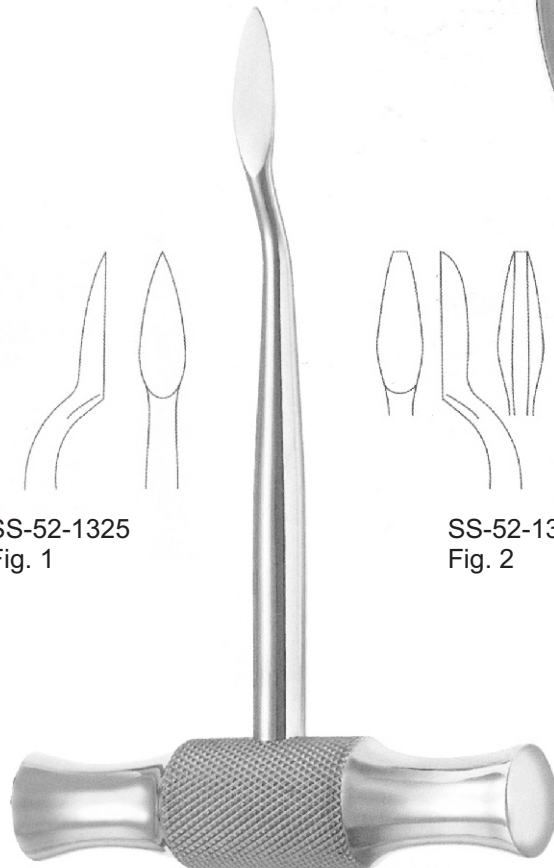
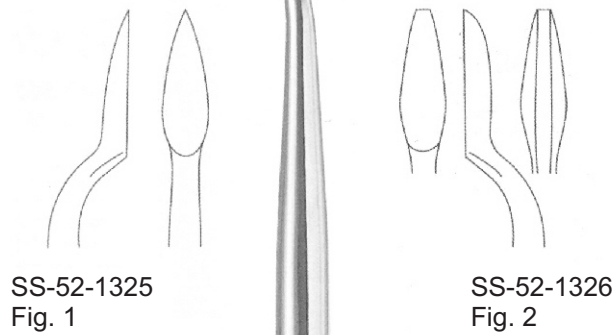
SS-52-1317
Fig. 2 A



COUPLAND



LOOS



LECLUSE



BARRY
 11 cm/4 1/4"



SS-52-1327
 Fig. 320 L



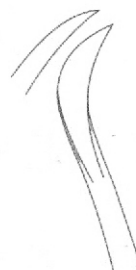
SS-52-1328
 Fig. 321 R



SS-52-1329
 Fig. 322



SS-52-1330
 Fig. 323



SS-52-1331
 Fig. 370



SS-52-1332
 Fig. 371



SS-52-1333
Fig. 1 L



SS-52-1334
Fig. 1 R



SS-52-1335
Fig. 11 L



SS-52-1336
Fig. 11 R



SS-52-1337
Fig. 12 L



SS-52-1338
Fig. 12 R



WINTER
11 cm/4 1/4"



SS-52-1339
Fig. 13 L



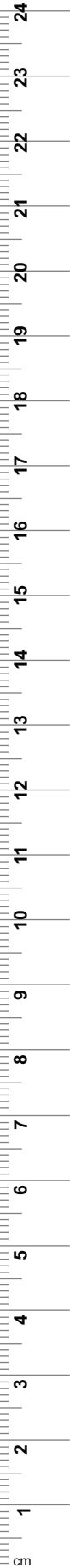
SS-52-1340
Fig. 13 R

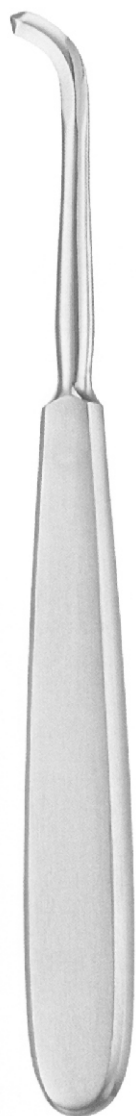
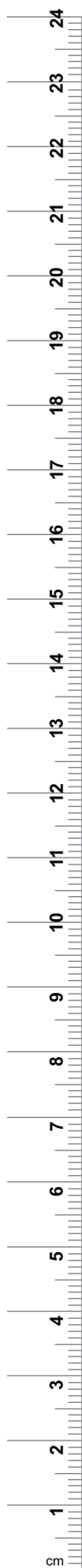


SS-52-1341
Fig. 14 L



SS-52-1342
Fig. 14 R

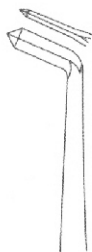




CHOMPRET



SS-52-1343
Fig. 1



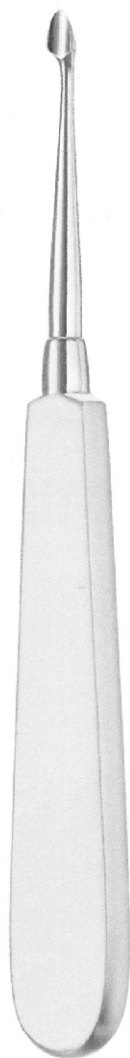
SS-52-1344
Fig. 2



SS-52-1345
Fig. 3



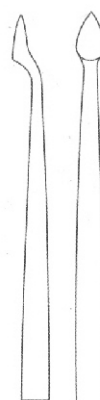
SS-52-1346
Fig. 4



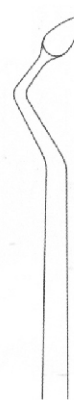
BERNARD



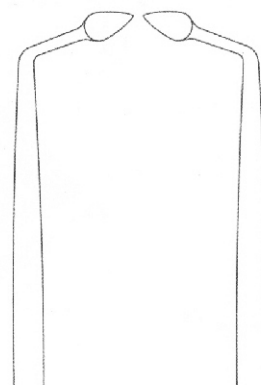
SS-52-1347
Fig. 0



SS-52-1348
Fig. 1



SS-52-1349
Fig. 2



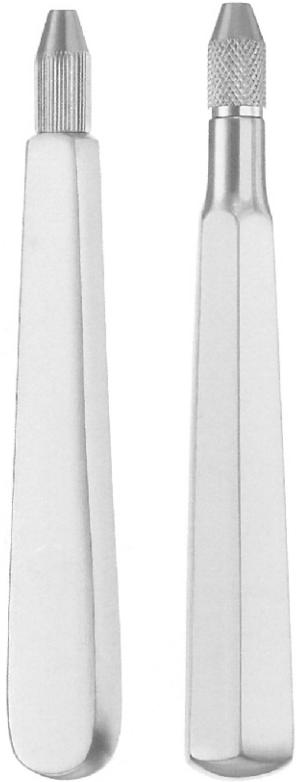
SS-52-1350
Fig. 6



SS-52-1351
Fig. 7



SS-52-1352
Fig. 11



BERNARD
Handle # A

BERNARD
Handle # B



SS-52-1353
Fig. 1



SS-52-1354
Fig. 2



SS-52-1355
Fig. 3



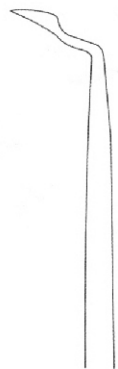
SS-52-1356
Fig. 4



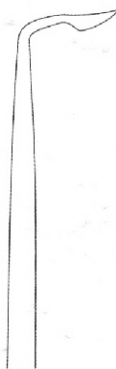
SS-52-1357
Fig. 5



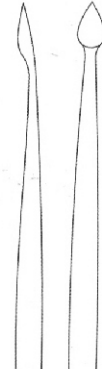
SS-52-1358
Fig. 10



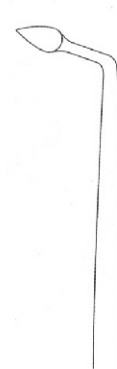
SS-52-1359
Fig. 8



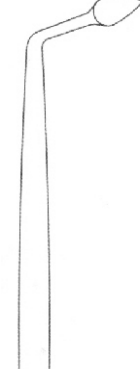
SS-52-1360
Fig. 9



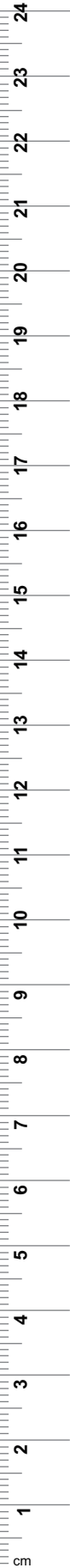
SS-52-1361
Fig. 11

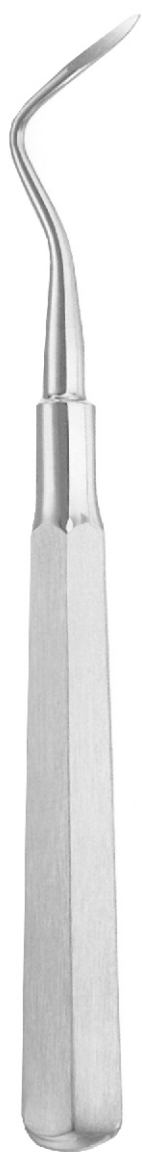


SS-52-1362
Fig. 7

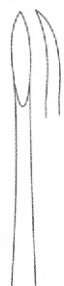


SS-52-1363
Fig. 6





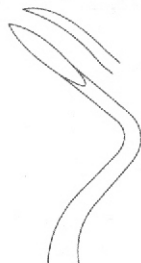
HEIDBRINK



SS-52-1366
Fig. 1



SS-52-1367
Fig. 2



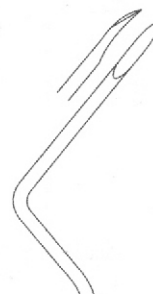
SS-52-1368
Fig. 3



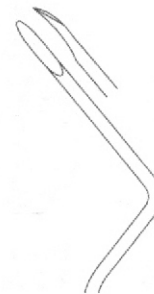
WEST (Apical)



SS-52-1369
Fig. 1



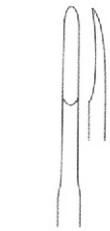
SS-52-1370
Fig. 2 R



SS-52-1371
Fig. 3 L



RATZOW



SS-52-1372
Fig. 1



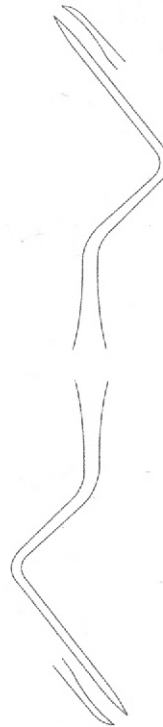
SS-52-1373
Fig. 2



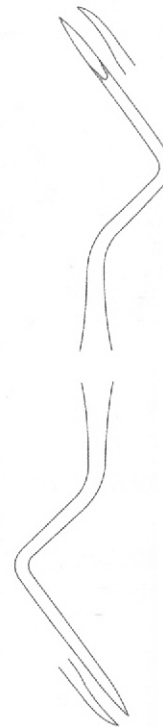
SS-52-1374
Fig. 3



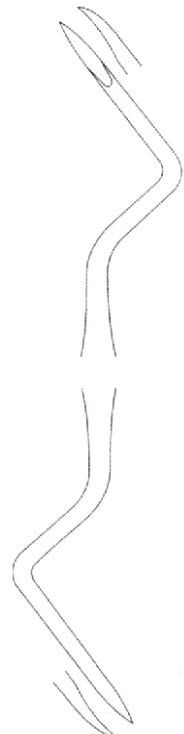
HEIDBRINK



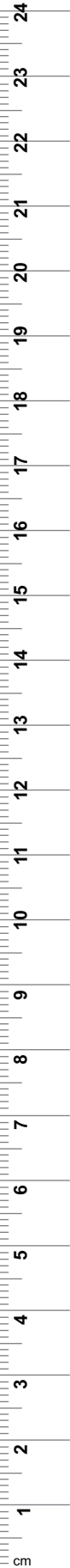
SS-52-1375
Fig. 1



SS-52-1376
Fig. 2

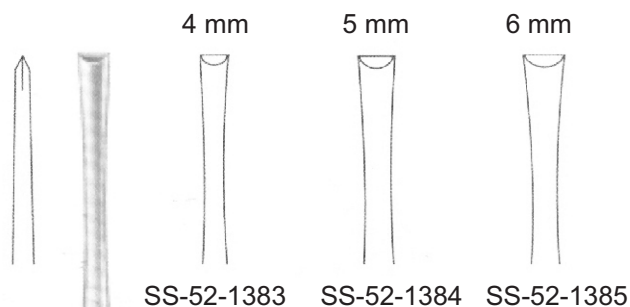
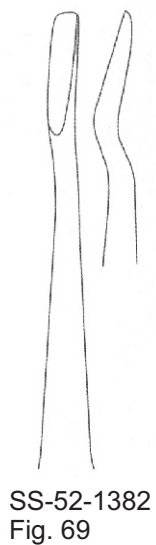
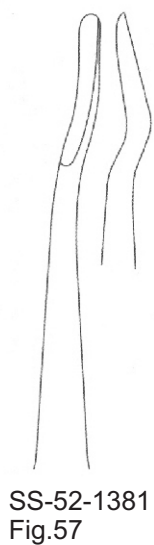
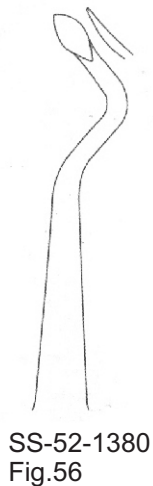
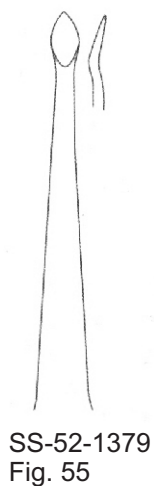
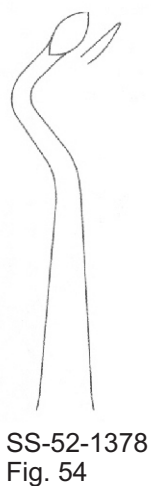


SS-52-1377
Fig. 23





VIGNAL



BARRY
21.5 cm/8 3/4"

53

- EN** Bone Files
- DE** Bone-Dateien
- ES** Archivos de huesos

Page 55 to 56





MILLER-COLBURN
18 cm/7"

downwards cutting

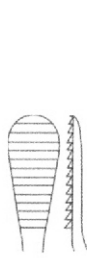
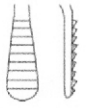


Fig. 1



SS-53-1401

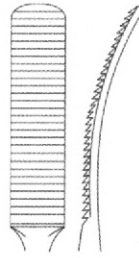
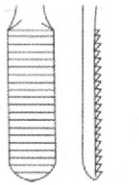


Fig. 2



SS-53-1402

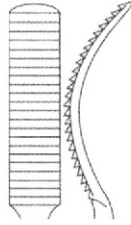
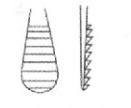


Fig. 3



SS-53-1403

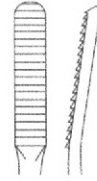
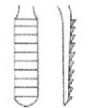


Fig. 4



SS-53-1404

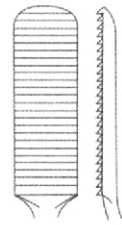
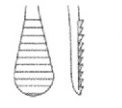


Fig. 5



SS-53-1405

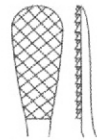


Fig. 1



SS-53-1406

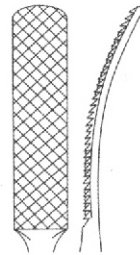
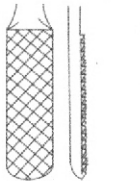


Fig. 2



SS-53-1407

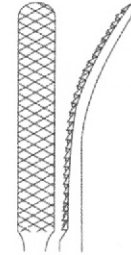


Fig. 3



SS-53-1408

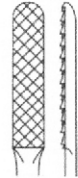
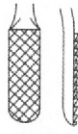


Fig. 4

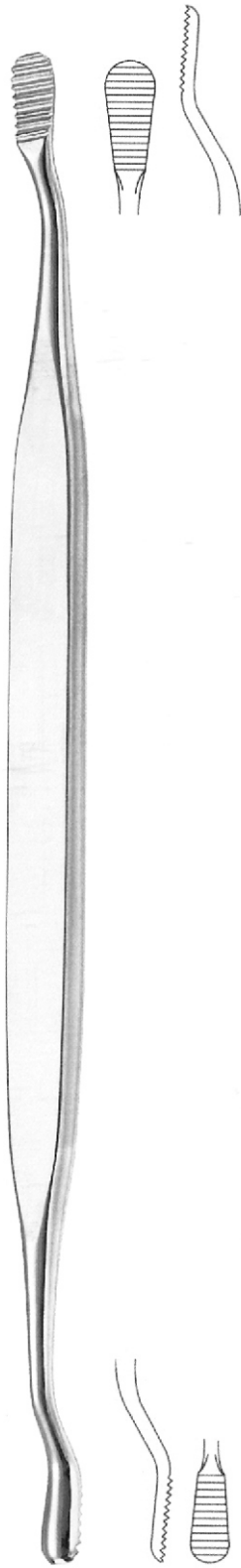


SS-53-1409

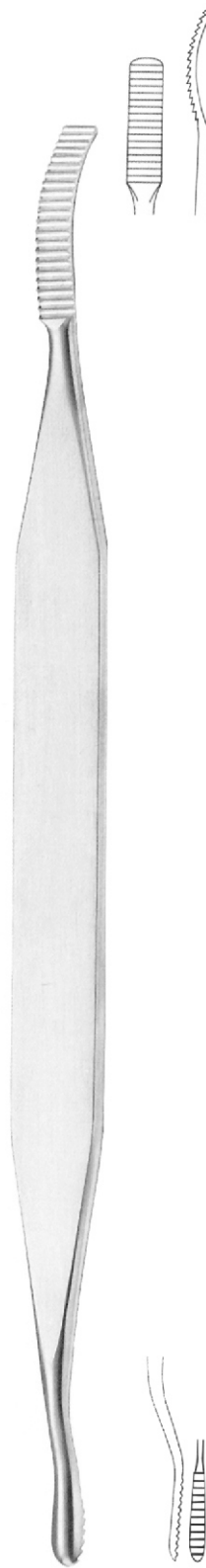
cross cut



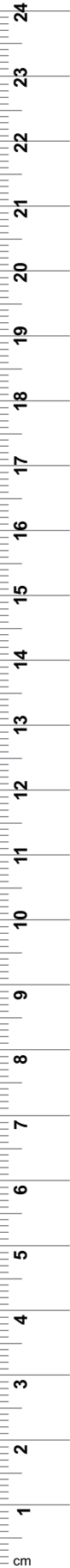
MILLER-COLBURN
18 cm/7"



SELDIN
 SS-53-1410
 18 cm/7"
 Fig. 11



SELDIN
 SS-53-1411
 18 cm/7"
 Fig. 12





54

EN

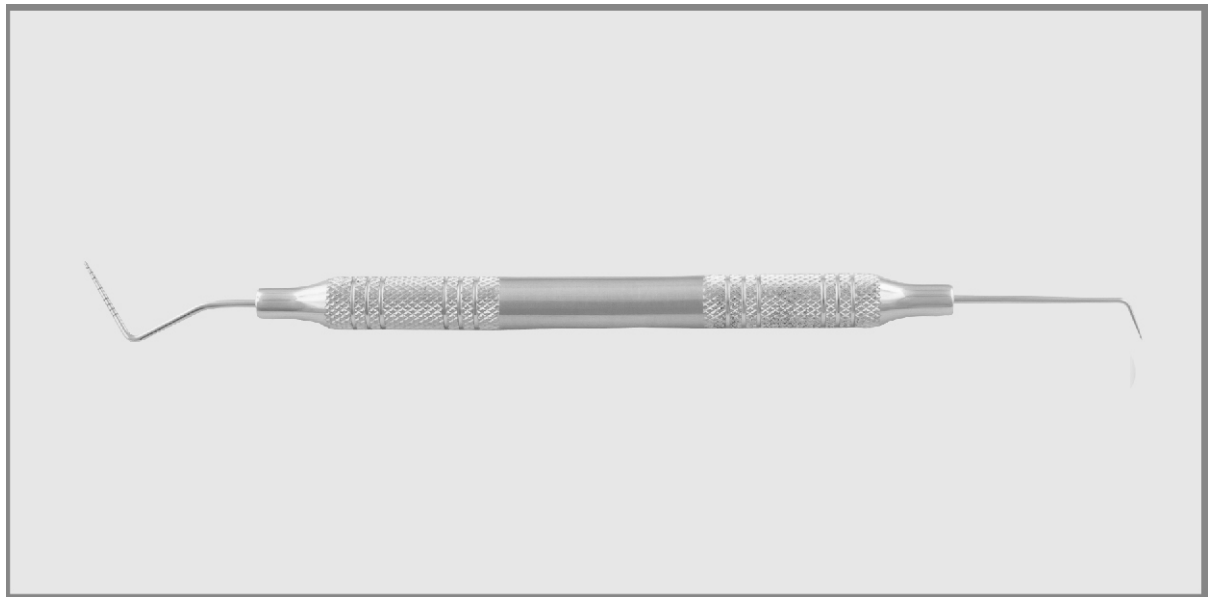
Dental Probes

DE

Zahnsonden

ES

Sondas dentales





3-6-8-11



Fig. 8
SS-54-1451

1-2-3-5-7-8-9-10



Fig. 10
SS-54-1452

3-6-8-11



Fig. 11
SS-54-1453

1-2-3-5-7-8-9-10



Fig. W
SS-54-1454
Williams

3-6-9-12



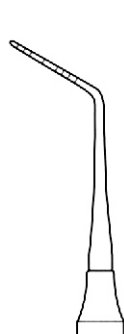
Mercury
SS-54-1455

1-2-3-5-7-8-9-10



Merrit A
SS-54-1456

1-2-3-5-7-8-9-10



Merrit E
SS-54-1457

1-2-3-5-7-8-9-10



Goldman-Fox
SS-54-1458

3-6-8



Michigan
SS-54-1459

3-6-9-12



Fig. CPNG 12S
SS-54-1460

3.5-5.5-8.5-11.5



Fig. CPG 11.5 WHO
SS-54-1461

3-6-9-12



Fig. CPG 12
SS-54-1462

1-2-3-4-5-6-7-8-9-10-11-12-13-14-15



Fig. CP 15 UNC
SS-54-1463

2-4-6-8-10-12



Fig. CPNG 22
SS-54-1464

1-2-3-5-7-8-9-10



Fig. 26G
SS-54-1465

Probes - Single Ended ●— EN
 Sonden - Single Ended ●— DE
 Sondas - terminación simple ●— ES



1-2-3-5-7-8-9-10
FLAT



Goldman-Fox
Williams
SS-54-1466

3-6-9-12

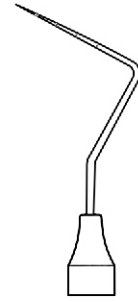
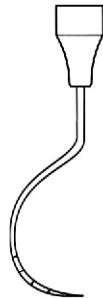


Fig. UT 3/4
Cattoni
SS-54-1467



12-9-6-3

1-2-3-5-7-8-9-10
FLAT

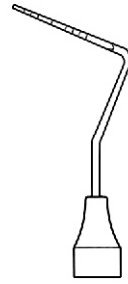
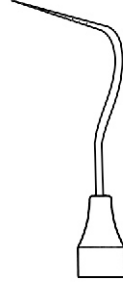


Fig. 3N
Nabers
SS-54-1468



10-9-8-7-5-3-2-1

1-2-3-5-7-8-9-10



Williams DE
Offset
SS-54-1469



10-9-8-7-5-3-2-1

3-6-9-12

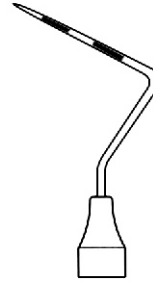


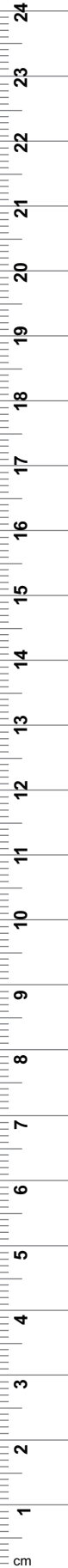
Fig. CP 12/Thin
Williams
SS-54-1470



10-9-8-7-5-3-2-1



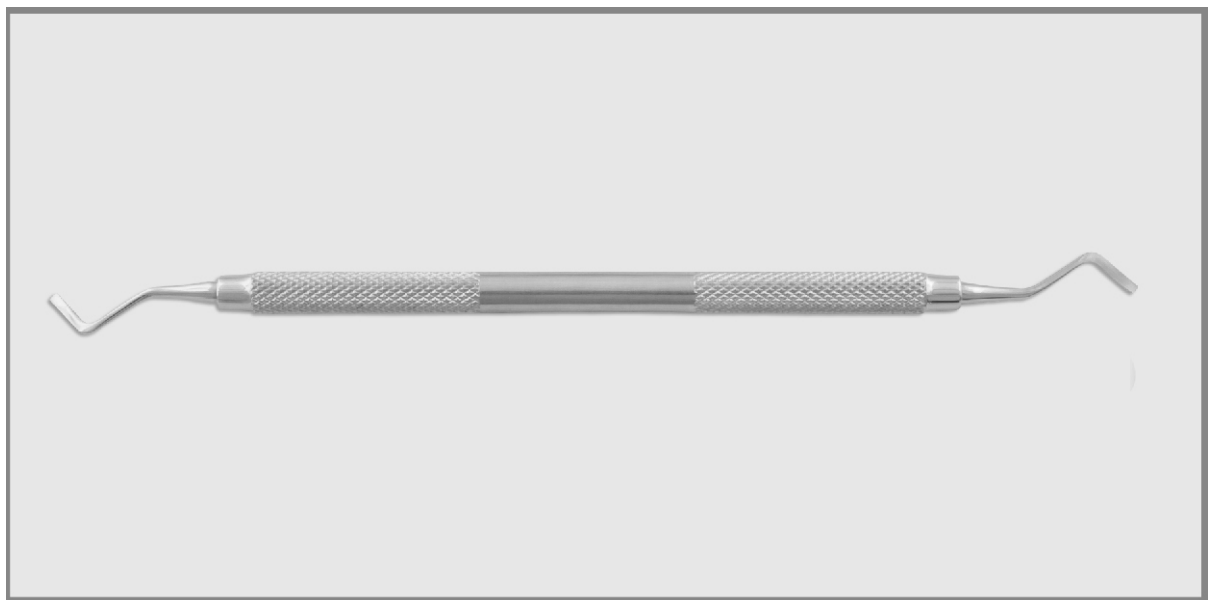
Nabers Furcation
probes graduated
working end
SS-54-1471

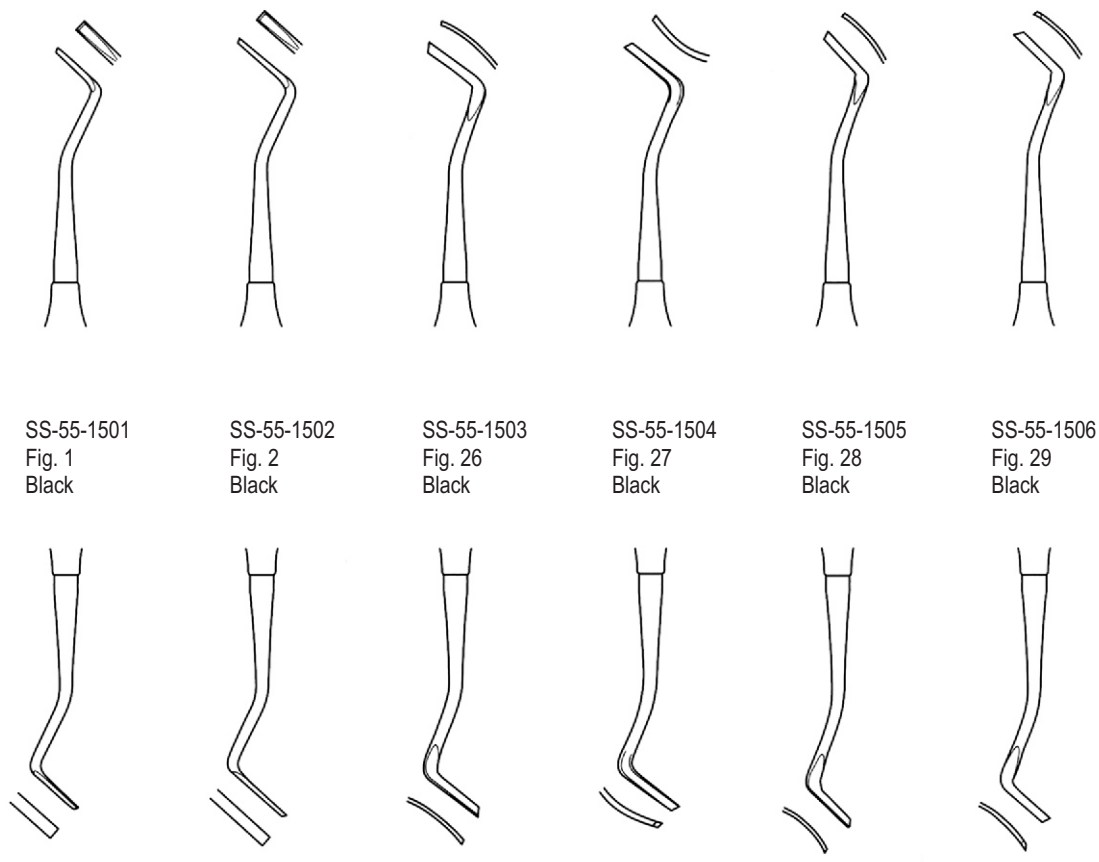


55

- EN** Enamel Instruments
- DE** Emaille-Instrumente
- ES** Instrumentos de esmalte

Page 59 to 62





SS-55-1501
 Fig. 1
 Black

SS-55-1502
 Fig. 2
 Black

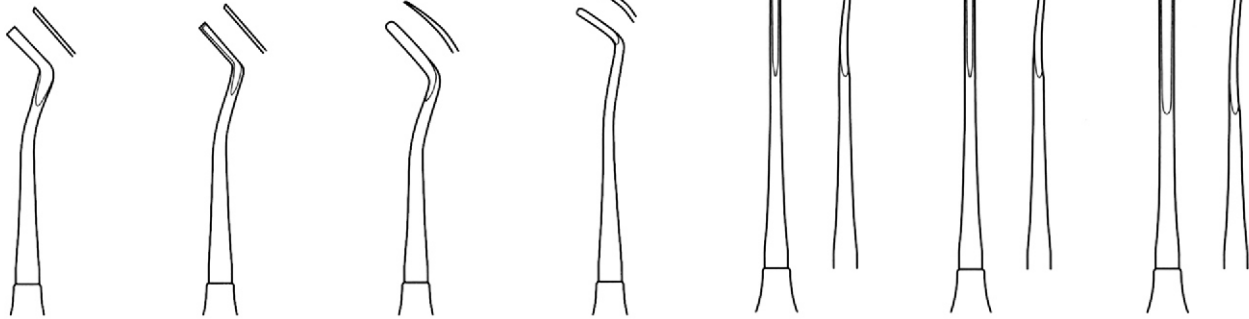
SS-55-1503
 Fig. 26
 Black

SS-55-1504
 Fig. 27
 Black

SS-55-1505
 Fig. 28
 Black

SS-55-1506
 Fig. 29
 Black

Chisels ● EN
 Meißel ● DE
 Cinceles ● ES



SS-55-1507
 Fig. 51/52
 Black

SS-55-1508
 Fig. 53/54
 Black

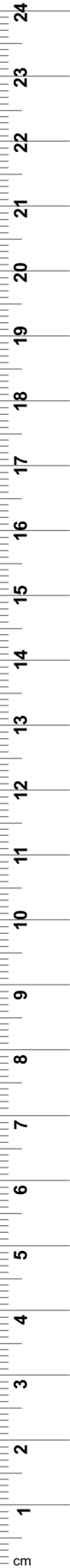
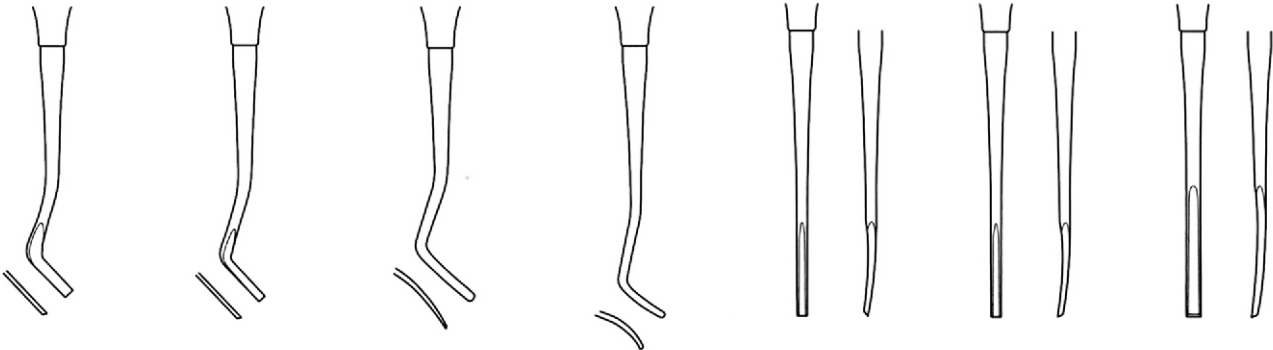
SS-55-1509
 Fig. 63/64
 Black

SS-55-1510
 Fig. 65/66
 Black

SS-55-1511
 Fig. 1/2
 Wedelstaedt

SS-55-1512
 Fig. 3/4
 Wedelstaedt

SS-55-1513
 Fig. 5/6
 Wedelstaedt





SS-55-1514
Fig. 8/9H



SS-55-1515
Fig. 13/14



SS-55-1516
Fig. 15/16



SS-55-1517
Fig. 17/18



SS-55-1518
Fig. 51/52



SS-55-1519
Fig. 53/54



SS-55-1520
Fig. 14/14
Off Angle



Chisels ● EN
 Meißel ● DE
 Cinceles ● ES



SS-55-1521
 Fig. 26
 Distal



SS-55-1522
 Fig. 27
 Mesial



SS-55-1523
 Fig. 28
 Distal



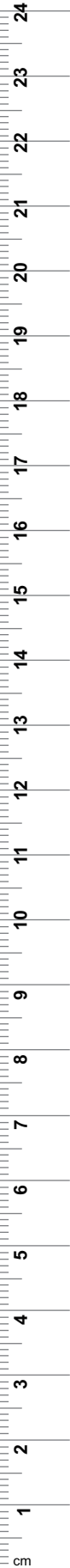
SS-55-1524
 Fig. 29
 Mesial



SS-55-1525
 Fig. 77/78
 Distal



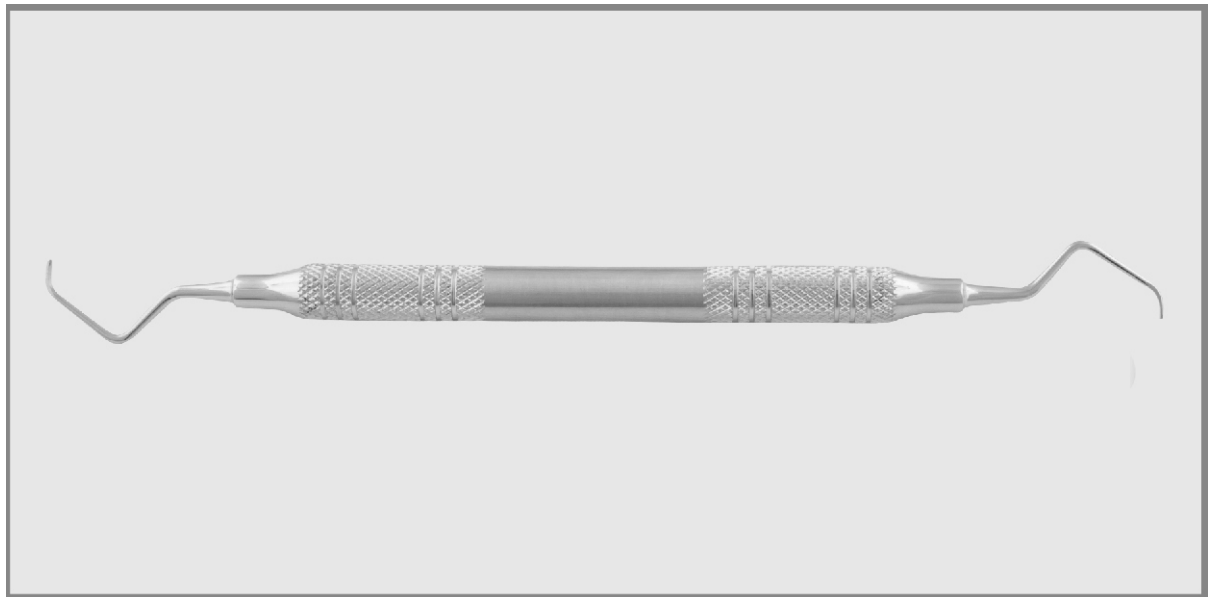
SS-55-1526
 Mesial
 54-1142-00



56

- EN** Dental Scalers
- DE** Zahnsteinentferner
- ES** Escaladores dentales

Page 63 to 78



- EN —● Explorers - Single Ended
- DE —● Forscher - Single Ended
- ES —● Explorers - Single Finded



Fig. 3
700-140

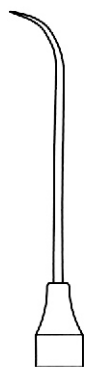


Fig. 3A
SS-56-1551



Fig. 5
SS-56-1552

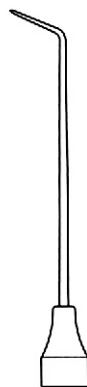


Fig. 6
SS-56-1553
6.5 mm

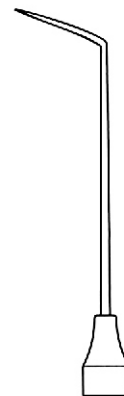


Fig. 6A
SS-56-1554
12 mm

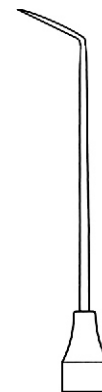


Fig. 6L
SS-56-1555
9 mm

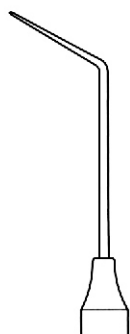


Fig. 6XL
SS-56-1556
12.5 mm



Fig. 8
SS-56-1557



Fig. 8A
SS-56-1558



Fig. 9
SS-56-1559



Fig. 10
SS-56-1560



Fig. 12
SS-56-1561



Fig. 17
SS-56-1562



Fig. 17A
SS-56-1563



Fig. 23
SS-56-1564
Shepherd's Hook



Fig. 54
SS-56-1565

Explorers - Double Ended ● EN
 Forscher - Doppelt beendat ● DE
 Exploradores - Doble final ● ES



Fig. UT 1/2
 SS-56-1566

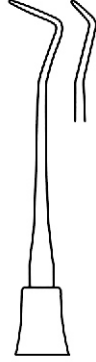


Fig. UT 2/2
 SS-56-1567

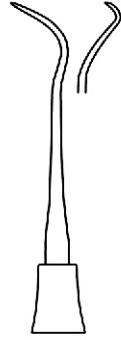


Fig. 3CH/3CH
 SS-56-1568



Fig. 6/3
 SS-56-1569



Fig. 16/3
 SS-56-1570



Fig. 2
 SS-56-1571

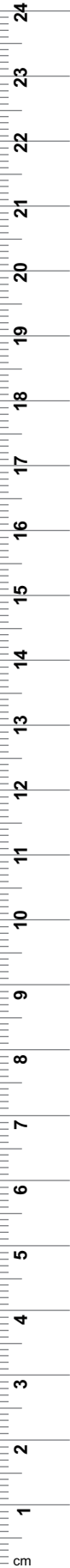
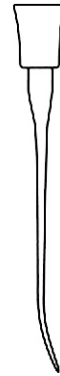
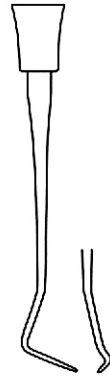




Fig. 23/17
SS-56-1572



Fig. 2A
SS-56-1573



Fig. 3
SS-56-1574



Fig. 1N
SS-56-1575
Nabers



Fig. 2N
SS-56-1576
Nabers

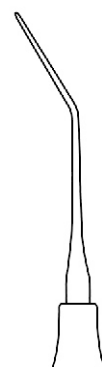


Fig. 5/6
SS-56-1577



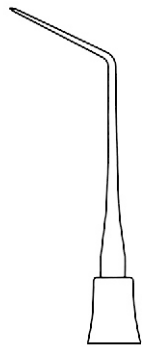


Fig. 16/23
SS-56-1578



Fig. 6/23
SS-56-1579



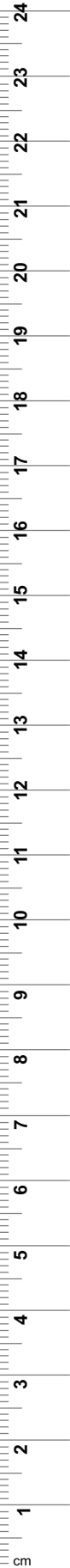
Fig. 6/17
SS-56-1580



Fig. 23/17A
SS-56-1581



Fig. 3/23
SS-56-1582





SS-56-1583
Fig. 1/2



SS-56-1584
Fig. 3/4



SS-56-1585
Fig. 5/6



SS-56-1586
Fig. 7/8



Gracey Curettes ● EN
Gracey Küretten ● DE
Gracey Curettes ● ES



SS-56-1587
Fig. 9/10



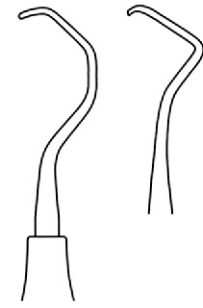
SS-56-1588
Fig. 11/12



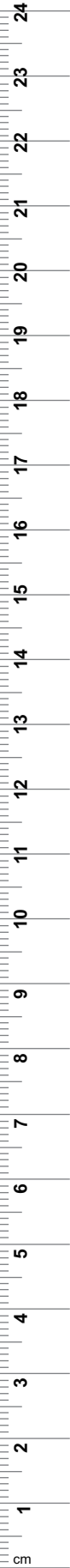
SS-56-1589
Fig. 13/14



SS-56-1590
Fig. 15/16



SS-56-1591
Fig. 17/18





Langer
 SS-56-1592
 Fig. 1/2



Langer
 SS-56-1593
 Fig. 3/4



Langer
 SS-56-1594
 Fig. 5/6

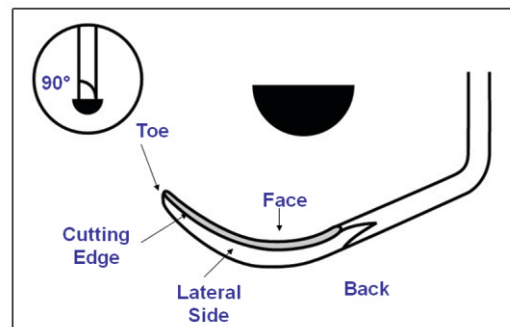


Langer
 SS-56-1595
 Fig. 17/18



Universal curettes are designed for easy adaptation on all tooth surfaces (thus the name "universal").

The blade of a universal curette has a round toe and back, and two cutting edges for scaling, making it an efficient design for scaling the entire mouth.



Universal Curettes ● EN
 Universalküretten ● DE
 Curetas universales ● ES



Columbia
 SS-56-1596
 Fig. 13/14



Columbia
 SS-56-1597
 Fig. 2R/2L



Columbia
 SS-56-1598
 Fig. 4R/4L



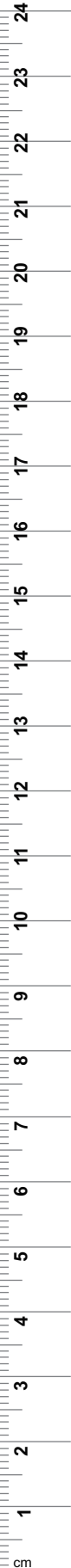
SS-56-1599
 Fig. Gx4

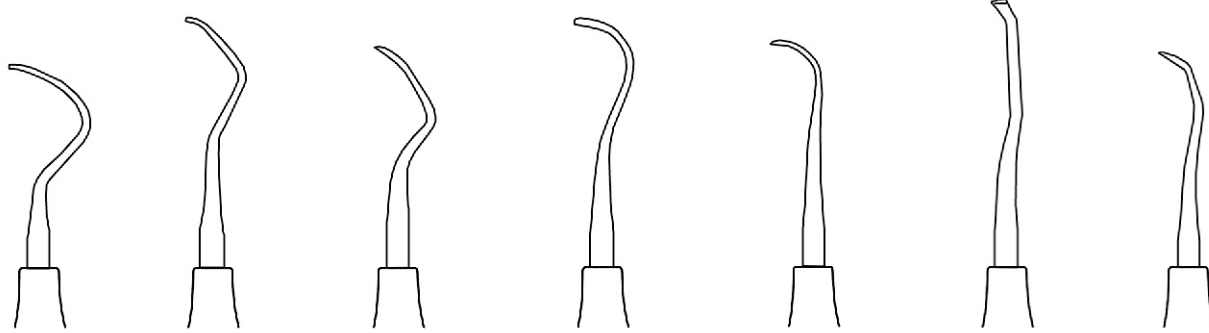


Barnhart
 SS-56-1600
 Fig. 1/2

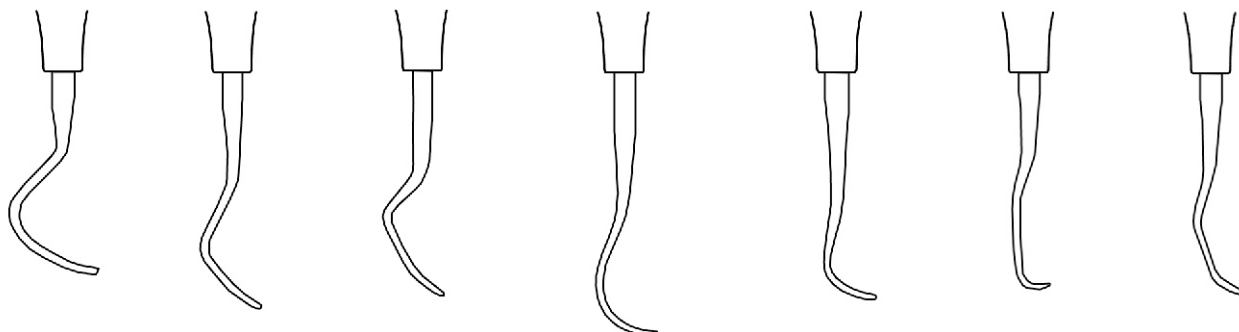


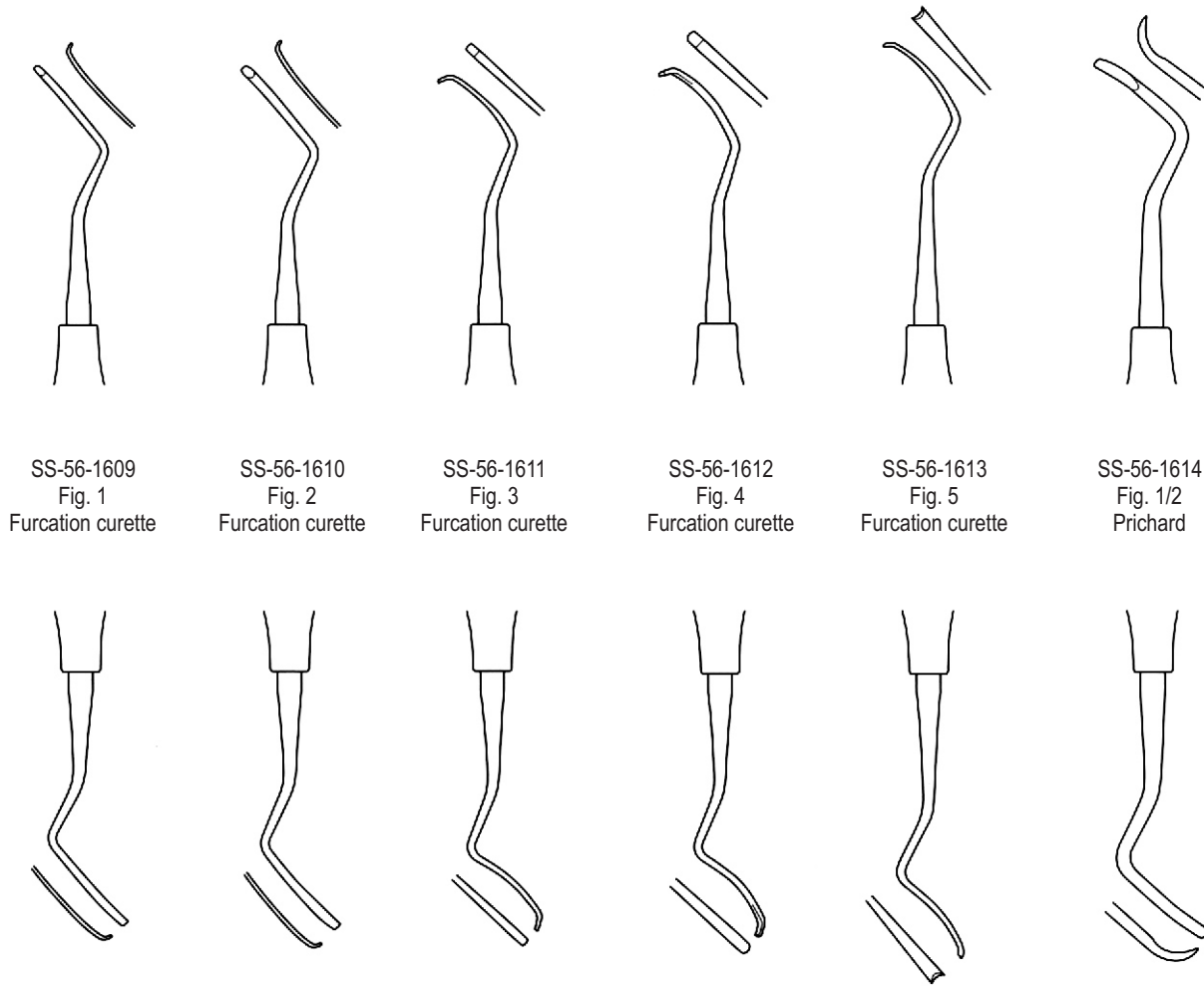
Barnhart
 SS-56-1601
 Fig. 5/6





SS-56-1602 Fig. Me1	SS-56-1603 Rule [23-24] Fig. 3/4	SS-56-1604 Fig. IU 13/14 Indiana University	SS-56-1605 Fig. IU 17/18 Indiana University	SS-56-1606 Fig. 7/8 Younger-Good	SS-56-1607 Fig. 1/2 Bunting	SS-56-1608 Fig. 5/6 Bunting
------------------------	--	---	---	--	-----------------------------------	-----------------------------------





SS-56-1609
 Fig. 1
 Furcation curette

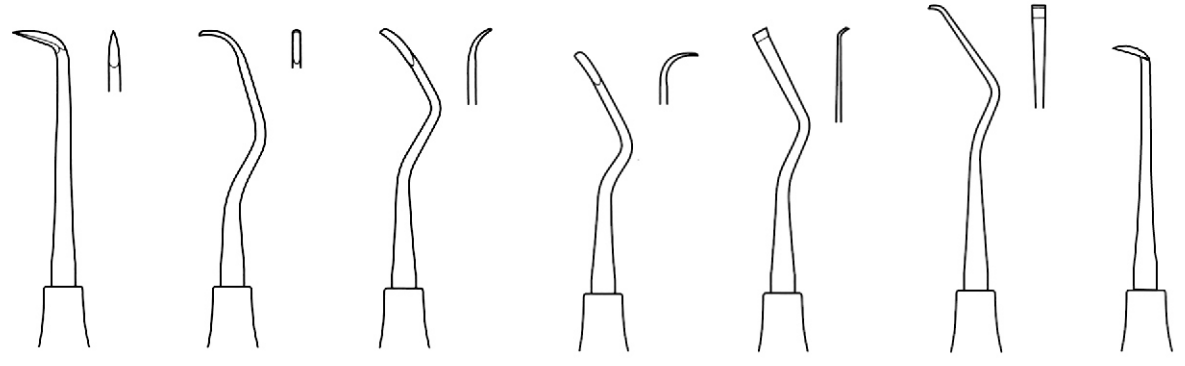
SS-56-1610
 Fig. 2
 Furcation curette

SS-56-1611
 Fig. 3
 Furcation curette

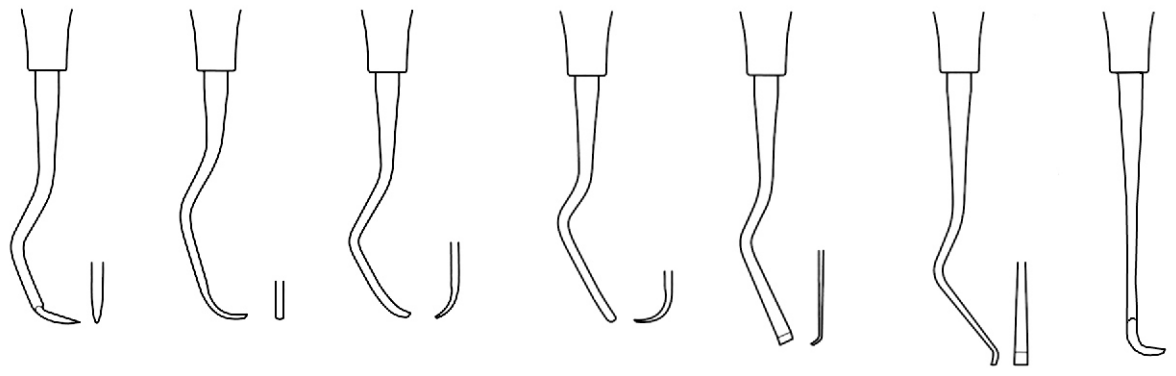
SS-56-1612
 Fig. 4
 Furcation curette

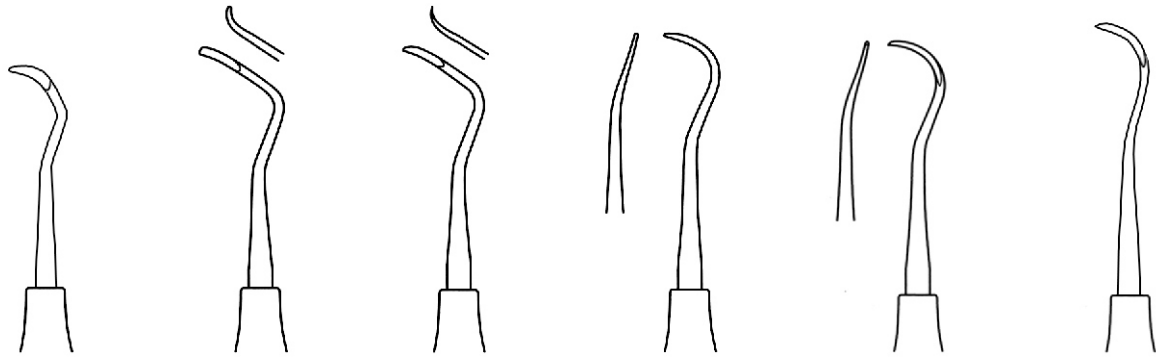
SS-56-1613
 Fig. 5
 Furcation curette

SS-56-1614
 Fig. 1/2
 Prichard



SS-56-1615 Goldman-Fox Fig. 1 SS-56-1616 Goldman-Fox Fig. 2 SS-56-1617 Goldman-Fox Fig. 3 SS-56-1618 Goldman-Fox Fig. 4 SS-56-1619 Goldman-Fox Fig. 5 SS-56-1620 Goldman-Fox Fig. 6 SS-56-1621 Goldman-Fox Fig. 21





SS-56-1622
 McCall
 Fig. 11/12

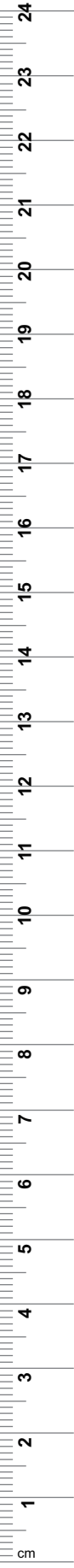
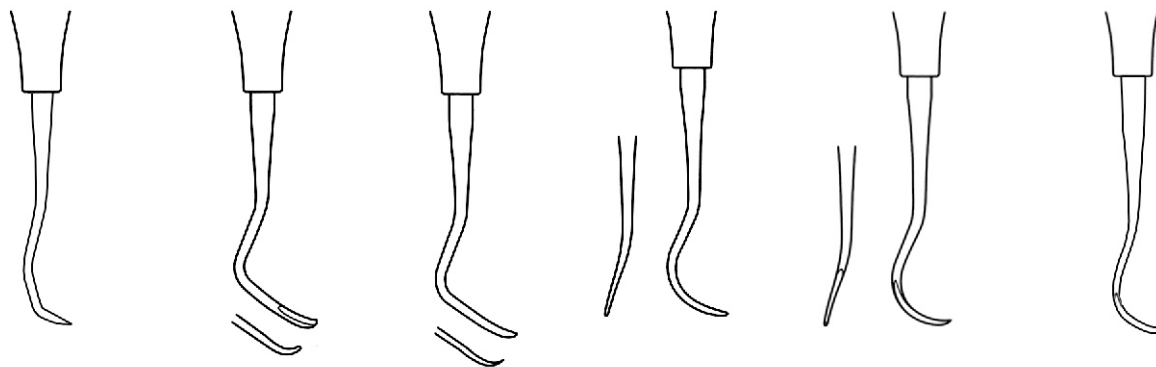
SS-56-1623
 McCall
 Fig. 13S/14S

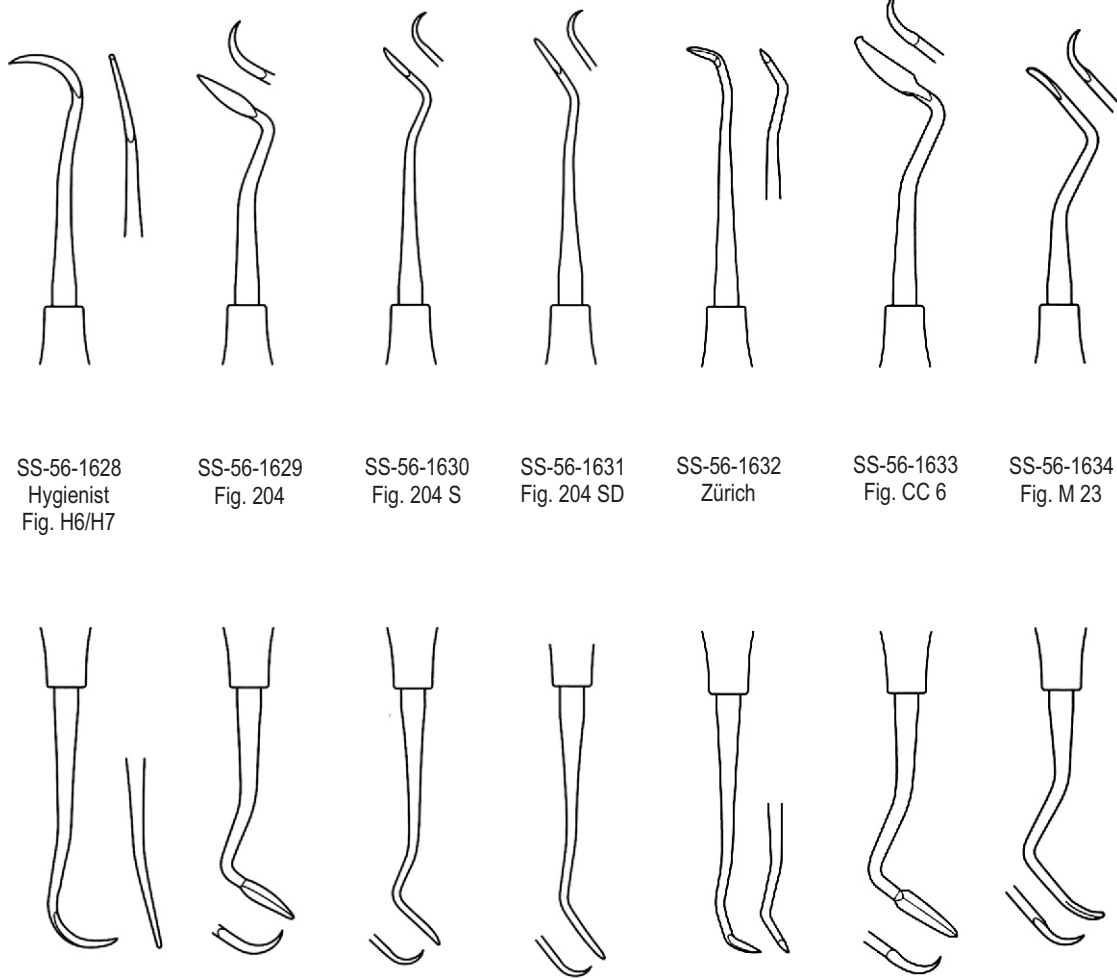
SS-56-1624
 McCall
 Fig. 13SM/14

SS-56-1625
 McCall
 Fig. 17/18

SS-56-1626
 McCall
 Fig. 17S/18S

SS-56-1627
 McCall
 Fig. 19/20





SS-56-1628
Hygienist
Fig. H6/H7

SS-56-1629
Fig. 204

SS-56-1630
Fig. 204 S

SS-56-1631
Fig. 204 SD

SS-56-1632
Zürich

SS-56-1633
Fig. CC 6

SS-56-1634
Fig. M 23

Sickle Scaler ● EN
 Sichel-Scaler ● DE
 Escalador de hoz ● ES



SS-56-1635
Hygienist-Towner
Fig. H5/33

SS-56-1636
Towner
Fig. U15/30

SS-56-1637
Towner
Fig. U15/33

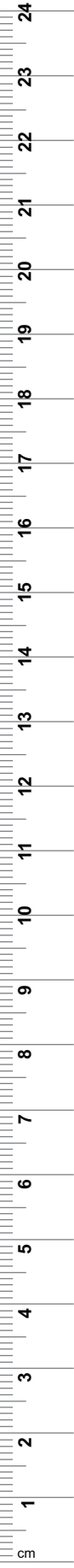
SS-56-1638
Hygienist-Towner
Fig. H5/U15

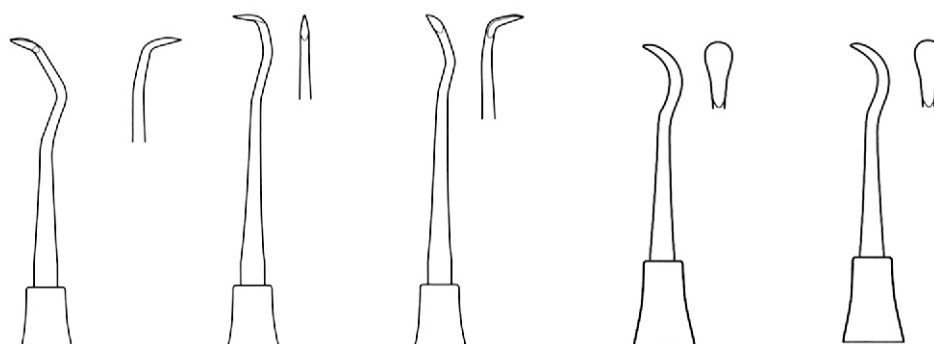
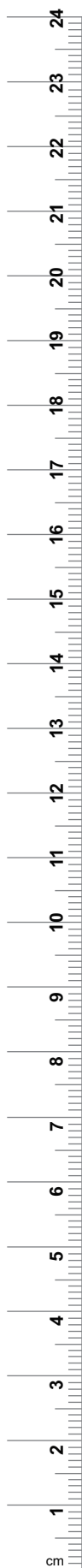
SS-56-1639
Fig. U 135

SS-56-1640
Fig. CI 2/3

SS-56-1641
Taylor
Fig. T2/T3

SS-56-1642
Younger-Good
Fig. 33/34





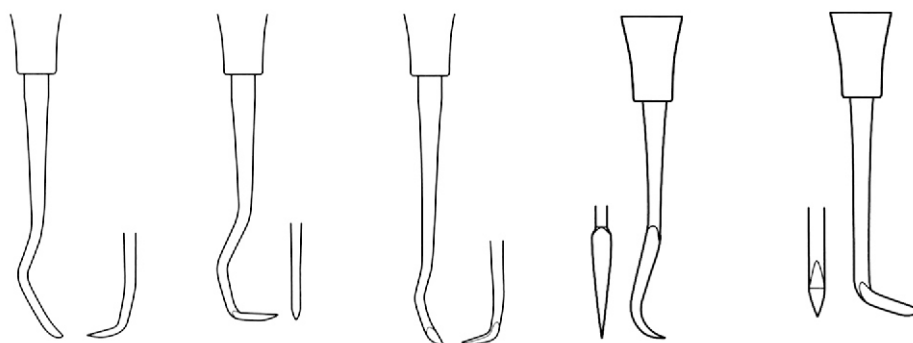
SS-56-1643
Jacquette
Fig. 31/32

SS-56-1644
Jacquette
Fig. 30/33

SS-56-1645
Jacquette
Fig. 34/35

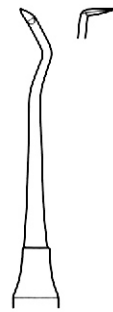
SS-56-1646
Cumine
Fig. 33

SS-56-1647
Mitchell
Fig. 34

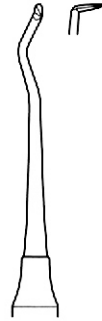




SS-56-1648
 Jacquette
 Fig. 33



SS-56-1649
 Jacquette
 Fig. 34



SS-56-1650
 Jacquette
 Fig. 35



SS-56-1651
 Ward-Kirkland
 Fig. 1



SS-56-1652
 Crane-Kaplan
 Fig. 2



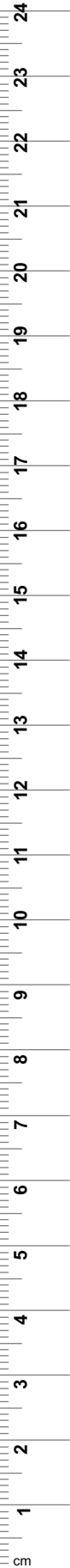
SS-56-1653
 Mercitan
 Fig. Sh5



SS-56-1654
 Crane-Kaplan
 Fig. 3



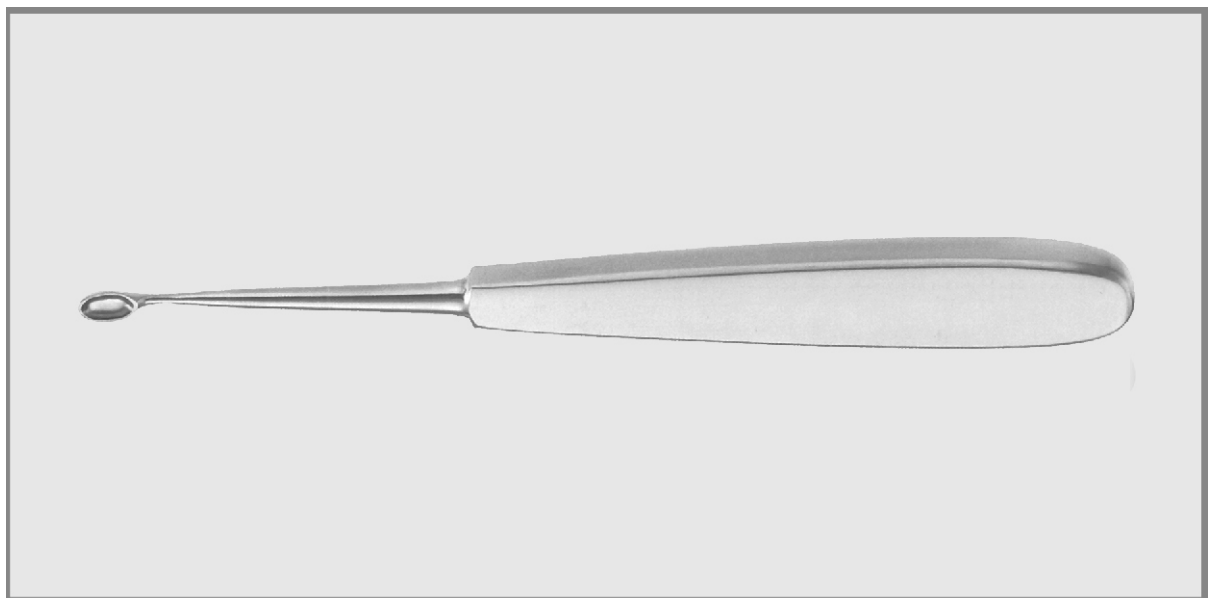
SS-56-1655
 White
 Fig. 12B



57

- EN** Bone Currettes
- DE** Knochenküretten
- ES** Curetas de hueso

Page 79 to 84





SS-57-1701
 SS-57-1702

SS-57-1703
 SS-57-1704



WILLIGER

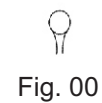


Fig. 00
 Fig. 0
 Fig. 1
 Fig. 2

SS-57-1705
 SS-57-1706
 SS-57-1707
 SS-57-1708

SS-57-1709
 SS-57-1710
 SS-57-1711
 SS-57-1712

SS-57-1713
 SS-57-1714
 SS-57-1715
 SS-57-1716

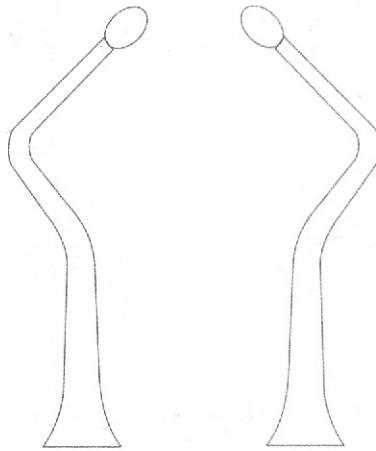
SS-57-1717
 SS-57-1718
 SS-57-1719
 SS-57-1720



Mod. USA

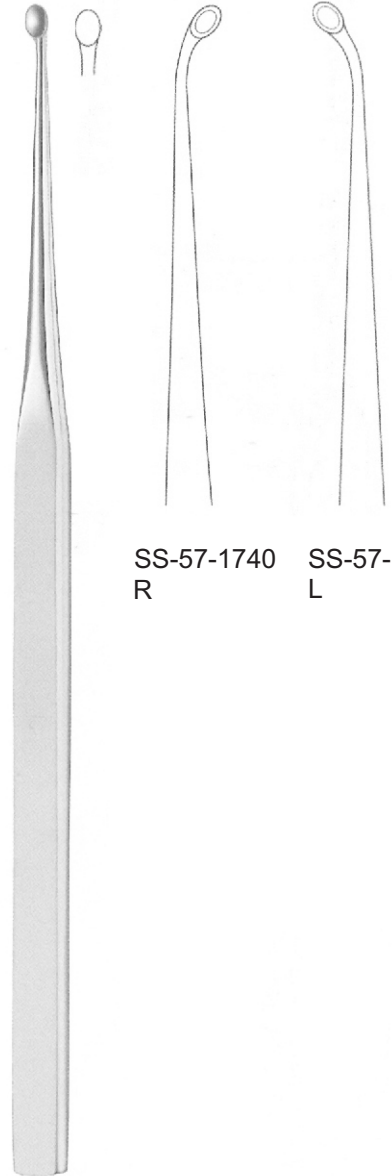


Fig. 1	SS-57-1721	SS-57-1727	SS-57-1733
Fig. 2	SS-57-1722	SS-57-1728	SS-57-1734
Fig. 3	SS-57-1723	SS-57-1729	SS-57-1735
Fig. 4	SS-57-1724	SS-57-1730	SS-57-1736
Fig. 5	SS-57-1725	SS-57-1731	SS-57-1737
Fig. 6	SS-57-1726	SS-57-1732	SS-57-1738



R

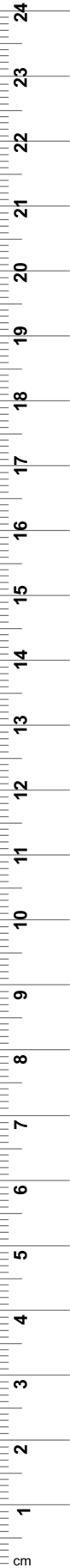
L



SS-57-1740
R

SS-57-1741
L

CHOMPRET
SS-57-1739





WILLGER

SS-57-1742
Fig. 00/00

SS-57-1743
Fig. 0/0

SS-57-1744
Fig. 1/1



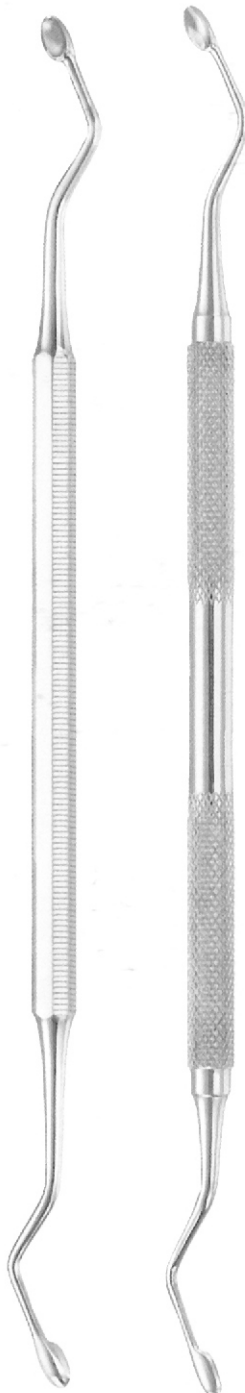
MARTINI

SS-57-1745
Fig. 00/00

SS-57-1746
Fig. 0/0

SS-57-1747
Fig. 1/1

SS-57-1748- SS-57-1750R-
SS-57-1749 SS-57-1751R



HEMINGWAY
18 CM/7"



SS-57-1752
SS-57-1753
Fig. 1R / 1L

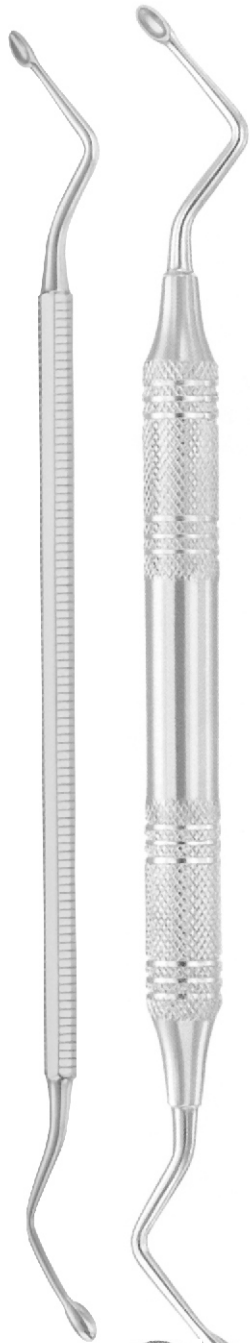


SS-57-1754
SS-57-1755
Fig. 2R / 2L

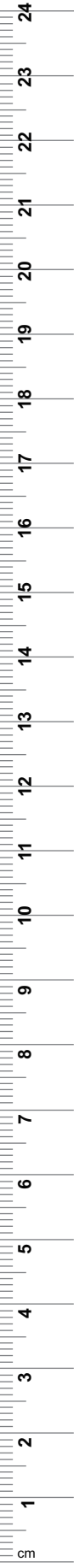
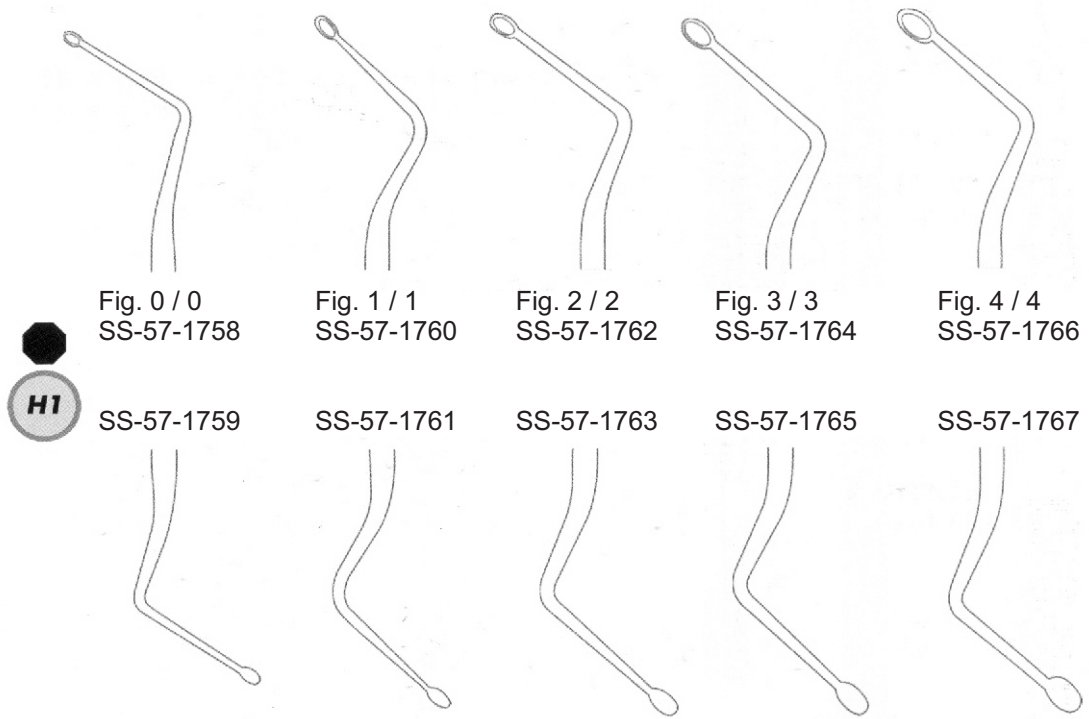


SS-57-1756
SS-57-1757
Fig. 3R / 3L

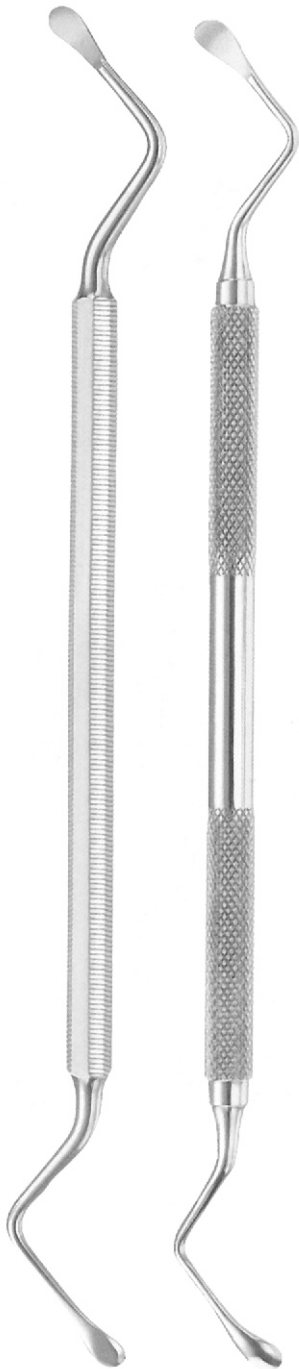




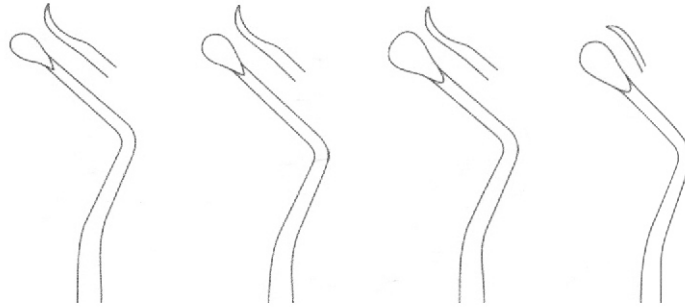
5,5 mm Ø9,5 mm
 HEMINGWAY
 17 cm/6 ¾"



SS-57-1768 SS-57-1770
 SS-57-1769 SS-57-1771



LUCAS
 17 cm/6¾"



SS-57-1772
 SS-57-1773
 Fig. 1 / 1

SS-57-1774
 SS-57-1775
 Fig. 2 / 2

SS-57-1776
 SS-57-1777
 Fig. 3 / 3

SS-57-1778
 SS-57-1779
 Fig. 4 / 4

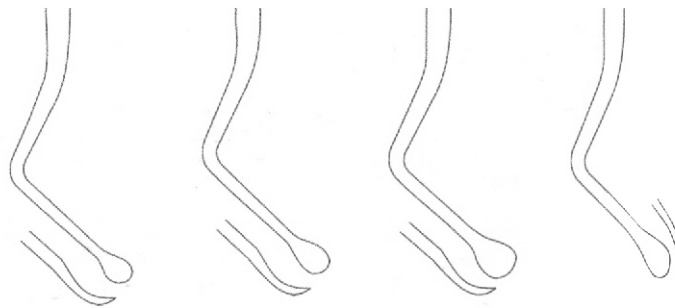




Fig. 4

SS-57-1780



Fig. 5

SS-57-1781



Fig. 1

SS-57-1782



Fig. 2

SS-57-1783



Fig. 3

SS-57-1784

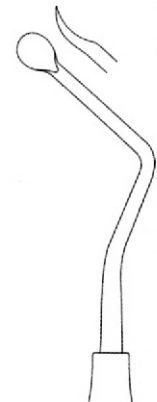
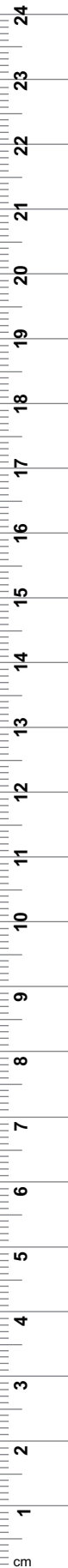


Fig. 4

SS-57-1785

MEAD

MILLER-COLBURN





58

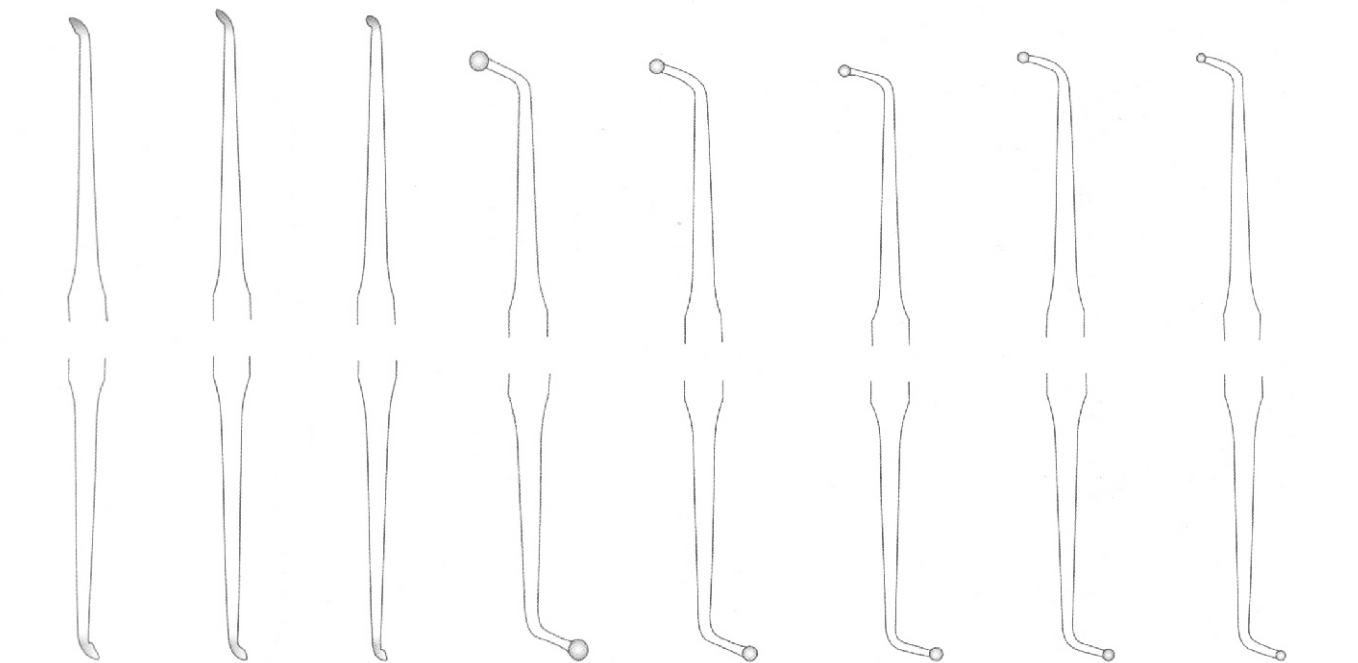
- EN** Excavators
- DE** Bagger
- ES** Excavadoras

Page 85 to 89

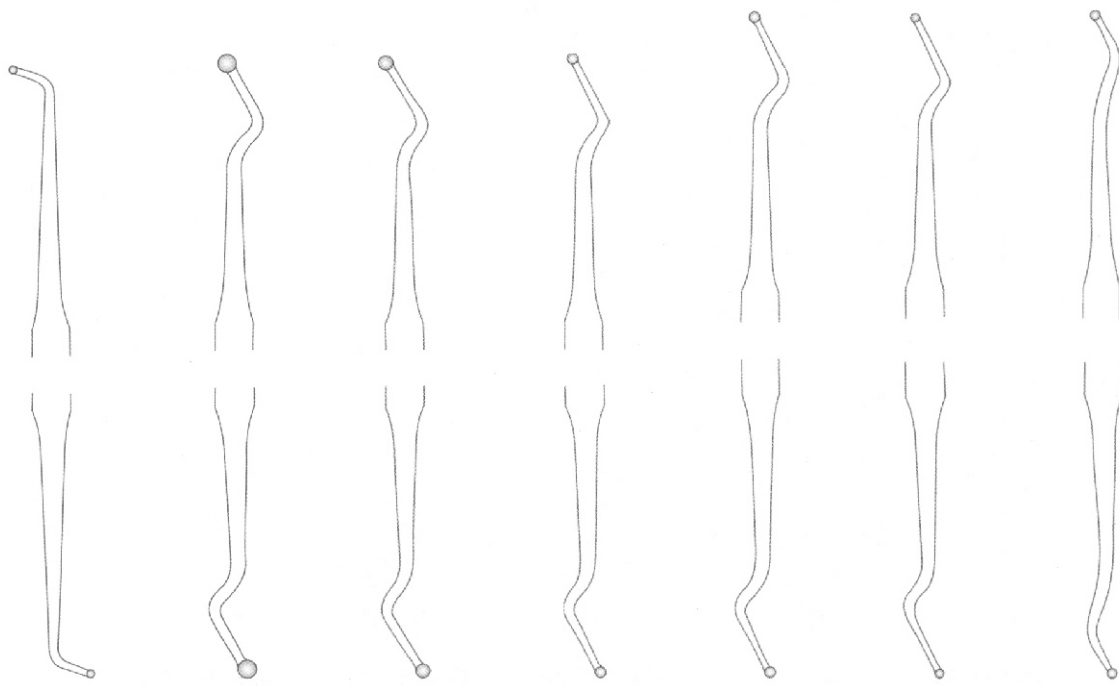




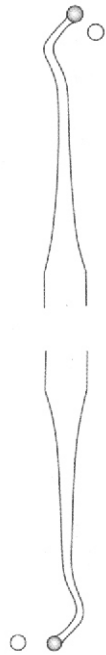
SS-58-1800
Fig.72/73



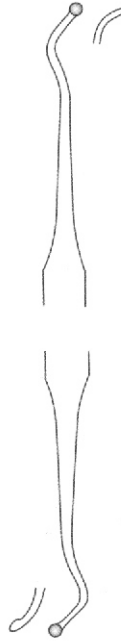
SS-58-1801 Fig. 73/74 SS-58-1802 Fig. 74/111 SS-58-1803 Fig. 111/112 SS-58-1804 Fig. 113/114 SS-58-1805 Fig. 115/116 SS-58-1806 Fig. 117/118 SS-58-1807 Fig. 119/120 SS-58-1808 Fig. 1121/122



SS-58-1809 Fig.123/124 SS-58-1810 Fig.125/126 SS-58-1811 Fig.127/128 SS-58-1812 Fig.129/130 SS-58-1813 Fig.131/132 SS-58-1814 Fig.133/134 SS-58-1815 Fig.155/156



SS-58-1816
 Fig.139/140



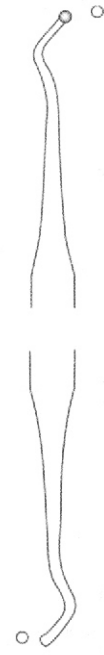
SS-58-1817
 Fig.141/142



SS-58-1818
 Fig.159/160



SS-58-1819
 Fig.161/162



SS-58-1820
 Fig.165/166



SS-58-1821
 Fig.171/172



SS-58-1822
 Fig.173/174



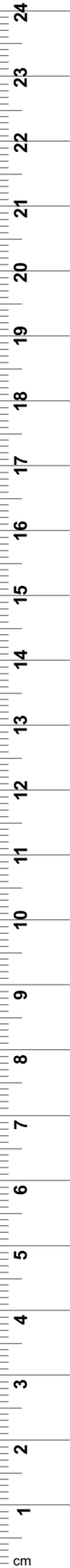
SS-58-1823
 Fig.175/176



SS-58-1824
 Fig.177/178



SS-58-1825
 Fig.179/180





SS-58-1826
Fig. 5



SS-58-1827
Fig. 13



WHITE
SS-58-1828
Fig. 14



SS-58-1829
Fig. 15



SS-58-1830
Fig. 17



SS-58-1831
Fig. 18



SS-58-1832
Fig. 19



WHITE
SS-58-1833
Fig. 20

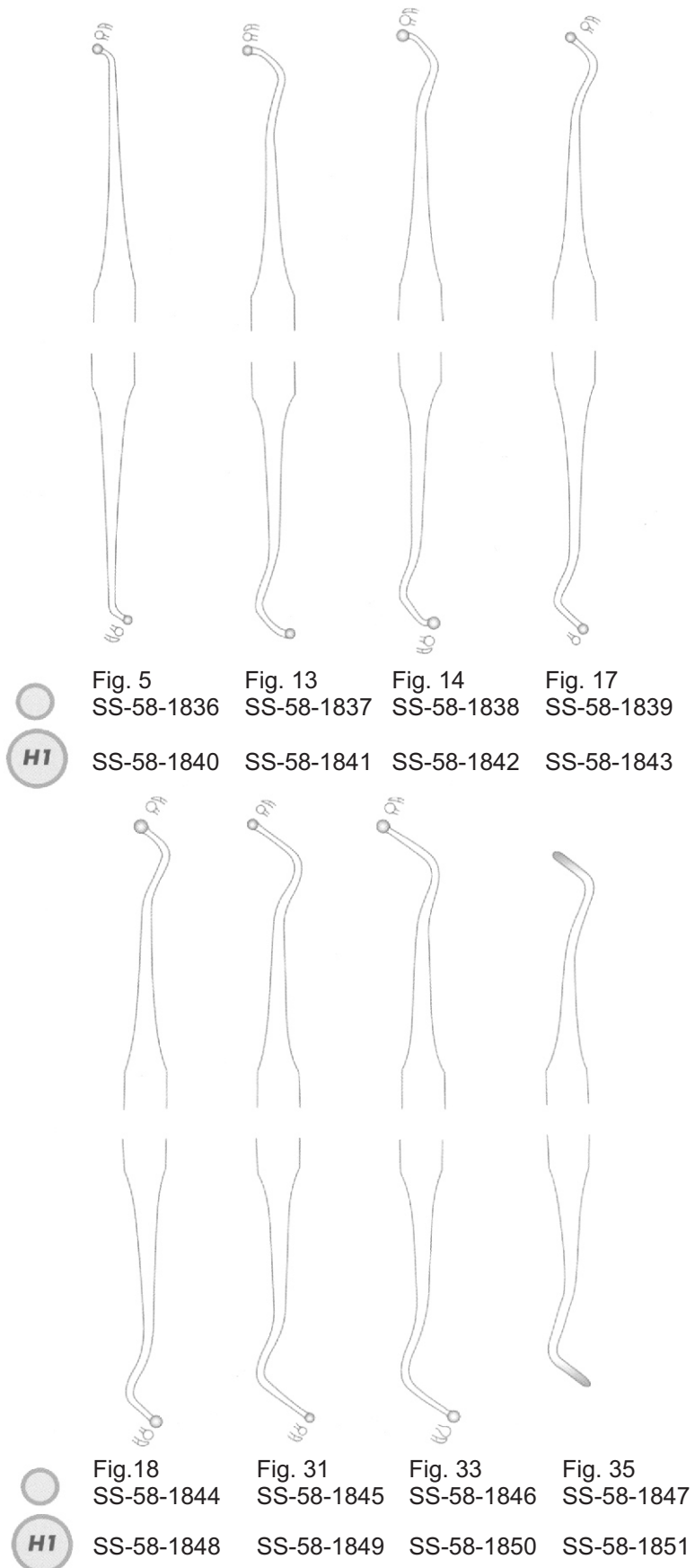


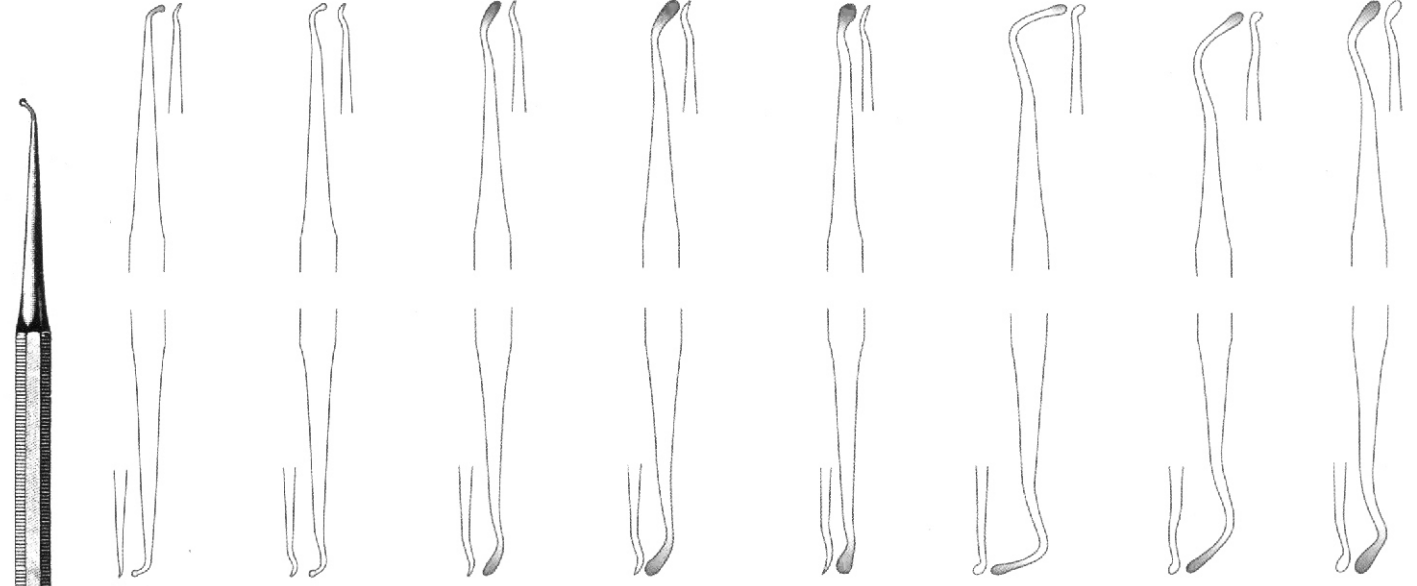
SS-58-1834
Fig. 23



SS-58-1835
Fig. 25

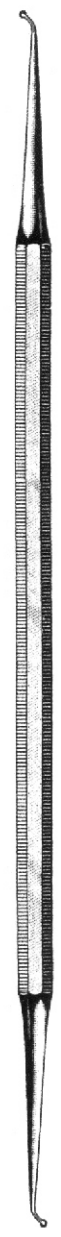
Excavators ● EN
 Exkavatoren ● DE
 Excavateurs ● ES





DARBY-PERRY

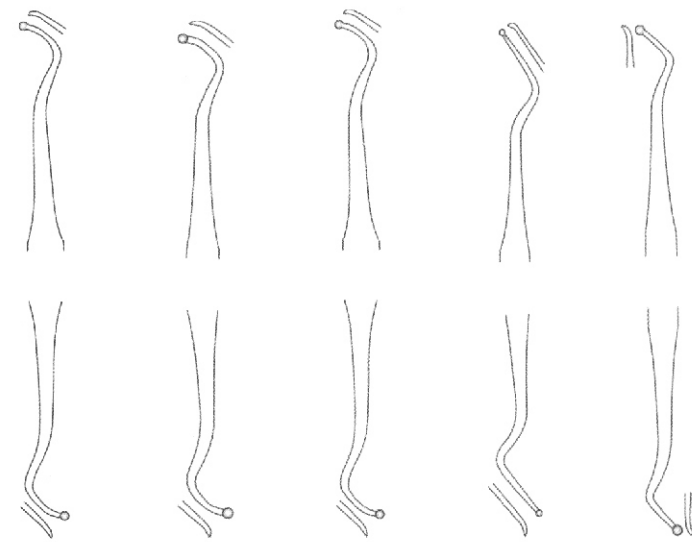
SS-58-1853 Fig. 7/8 SS-58-1854 Fig. 9/10 SS-58-1855 Fig. 11/12 SS-58-1856 Fig. 13/14 SS-58-1857 Fig. 15/16 SS-58-1858 Fig. 17/18 SS-58-1859 Fig. 19/20 SS-58-1860 Fig. 21/22



SS-58-1852
Fig. 5/6



5.5 mm



GILLET

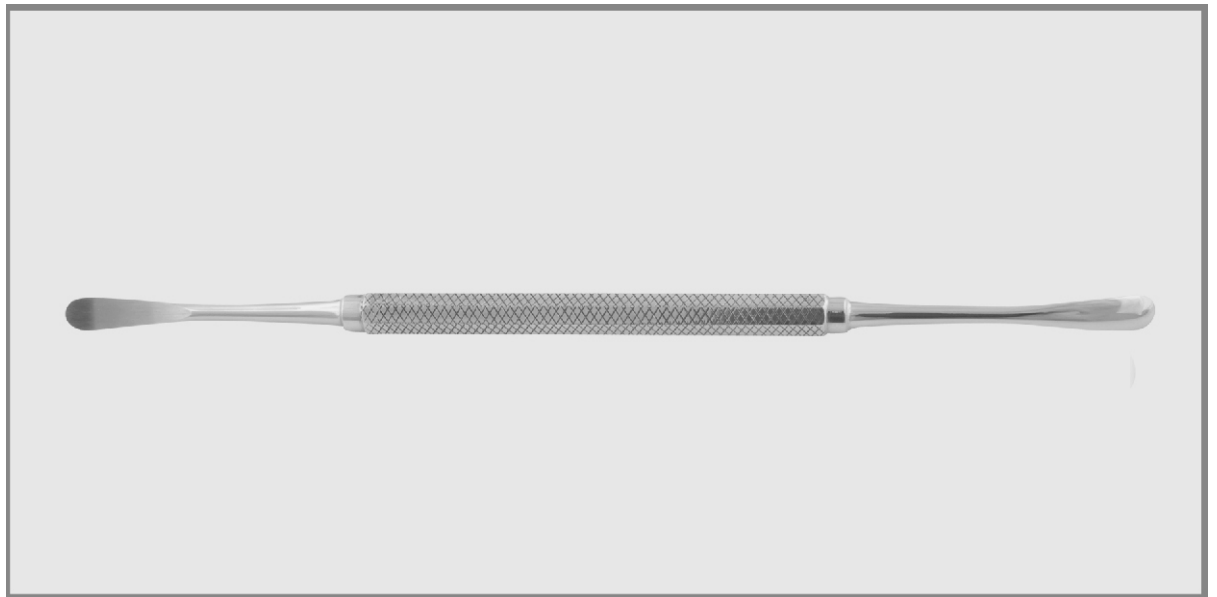
SS-58-1861 Fig. 4/5 SS-58-1862 Fig. 6/7 SS-58-1863 Fig. 7/8 SS-58-1864 Fig. 12/13 SS-58-1865 Fig. 14/15



59

- EN** Wax Proclein
- DE** Wachs-Porzellan
- ES** cera Porcelana

Page 90 to 94





● 5,5 mm



HI Ø9,5 mm



● SS-59-1901 Fig. 1



SS-59-1902 Fig. 2



SS-59-1903 Fig. 3



SS-59-1904 Fig. 4



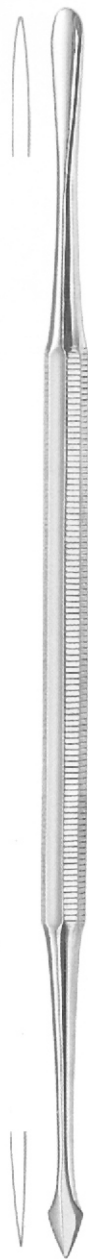
SS-59-1905 Fig. 5



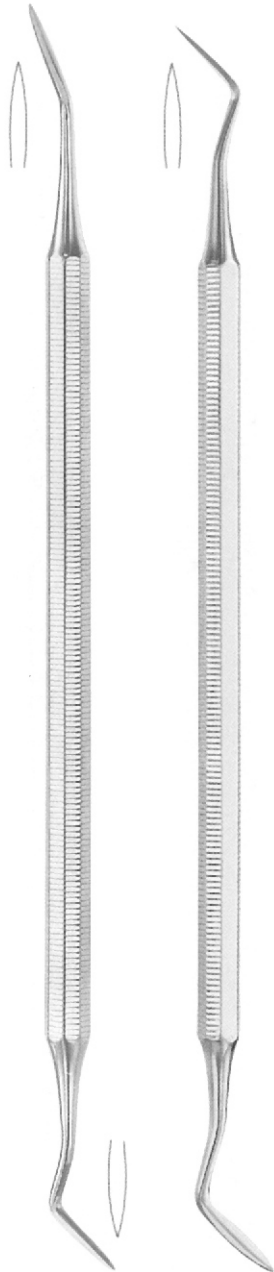
SS-59-1906H SS-59-1907H SS-59-1908H SS-59-1909H SS-59-1910H

Aluminium SS-59-1911 SS-59-1912 SS-59-1913 SS-59-1914 SS-59-1915

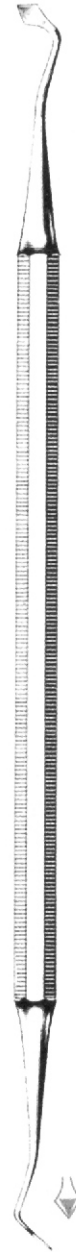
gold green blue red silver



GRITMAN
SS-59-1916



WARD
SS-59-1917 Fig. 1
SS-59-1918 Fig. 2



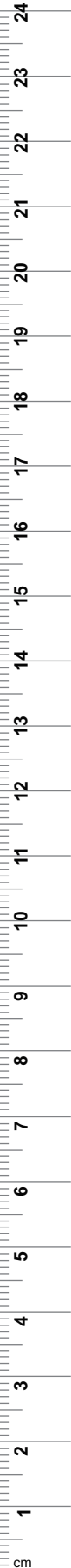
FRAHM
SS-59-1919

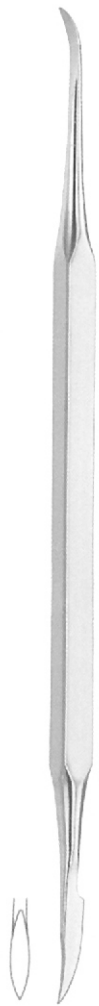


SHOSHAN
SS-59-1920
SHO-A



W.A.C.D.
SS-59-1921





HYLIN
SS-59-1922



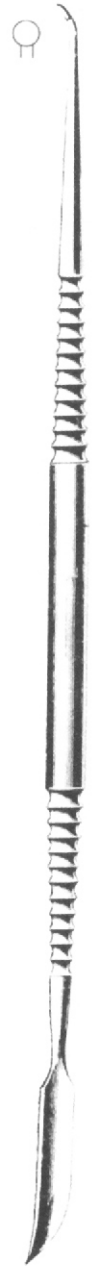
ZAHLE
SS-59-1923



SS-59-1924



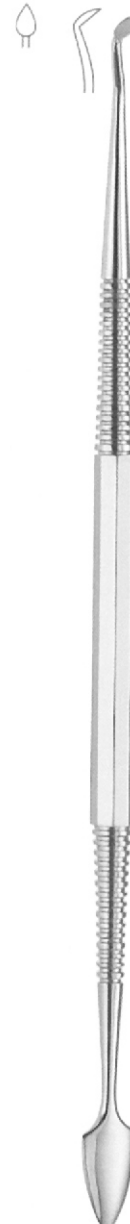
SS-59-1925



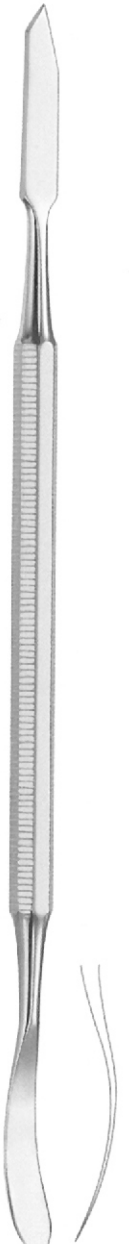
LE CRON
SS-59-1926



SS-59-1927



VEHE
SS-59-1928



FIELDSTAD
SS-59-1929

Scalpel Handles ● EN
 Skalpell-Griffe ● DE
 Mangos de FSsturies ● ES



ROACH
 SS-59-1930 SS-59-1931

RIEGNER
 SS-59-1932

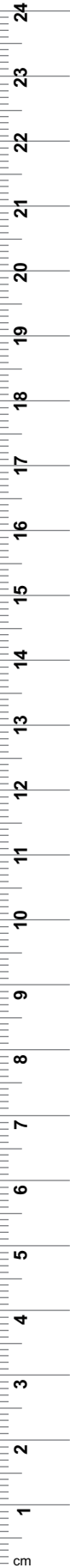
SS-59-1933
 Fig. 1

SS-59-1934
 Fig. 2

FRAHM
 SS-59-1935
 Fig. 6

SS-59-1936
 Fig. 10

SS-59-1937
 Fig. 6/10

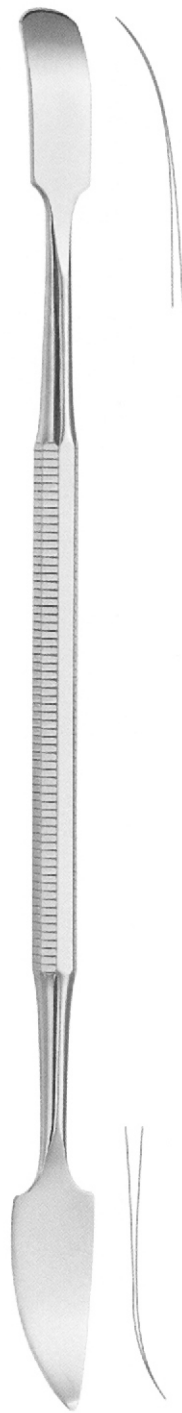




BEALE
 SS-59-1938
 Fig. 7A



SS-59-1939



GRITMAN
 SS-59-1940
 19,5 cm/7 3/4"



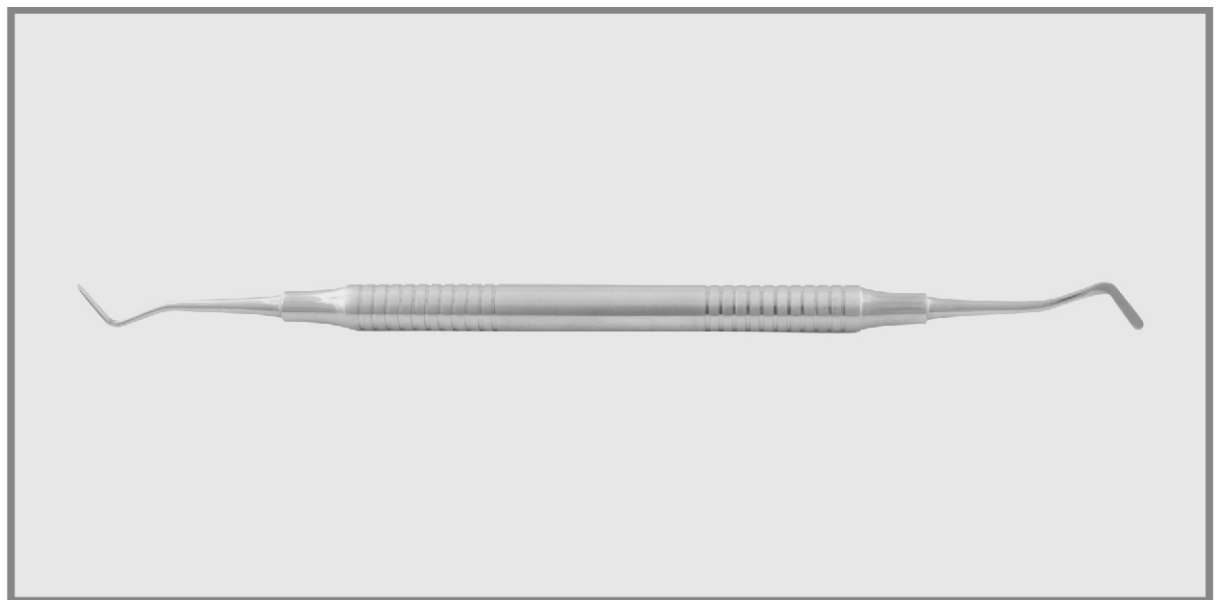
WESTON
 SS-59-1941

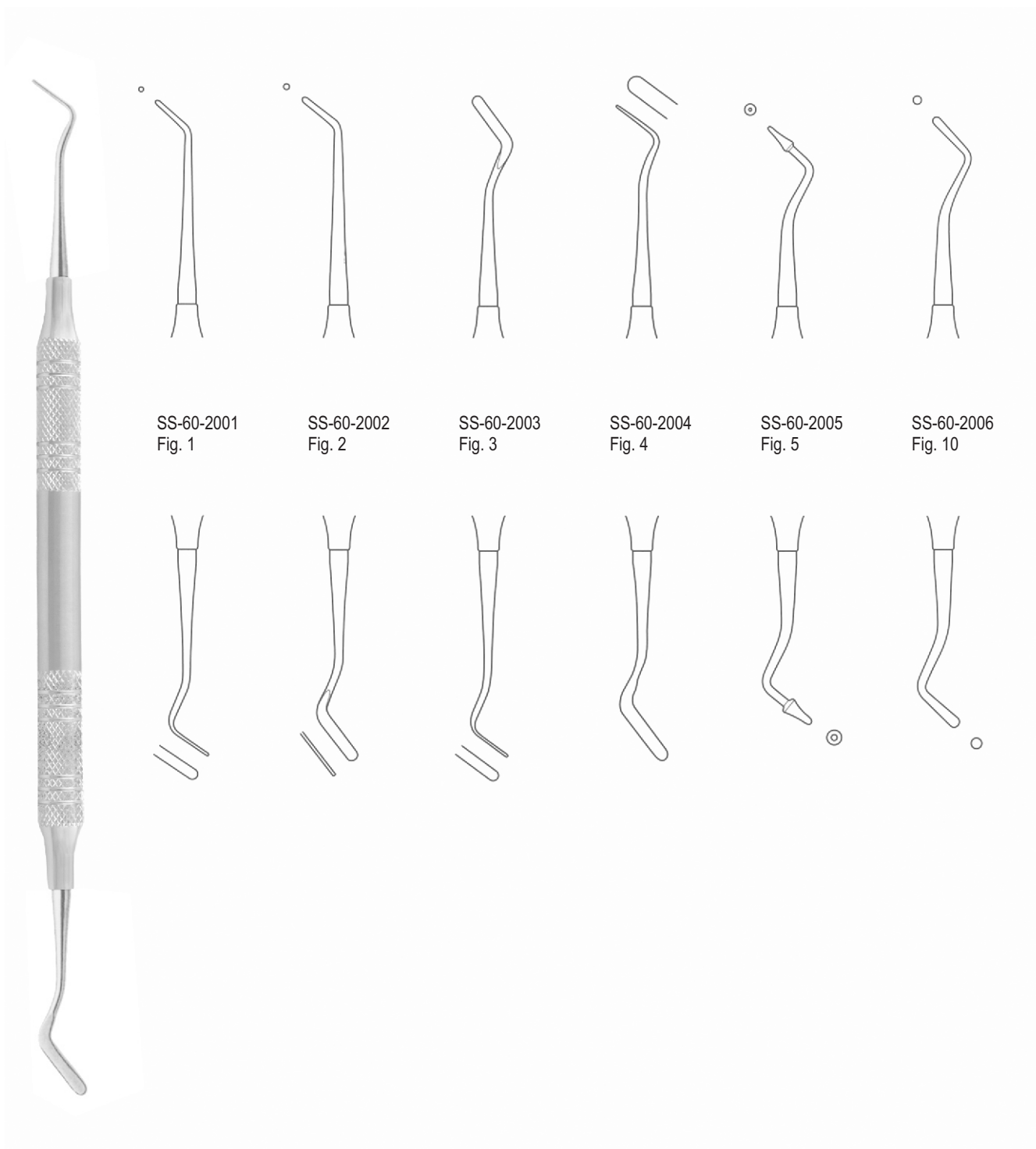


60

- EN** Filling Instruments
- DE** Füllungsinstrumente
- ES** Actos de llenado

Page 95 to 105





SS-60-2001
Fig. 1

SS-60-2002
Fig. 2

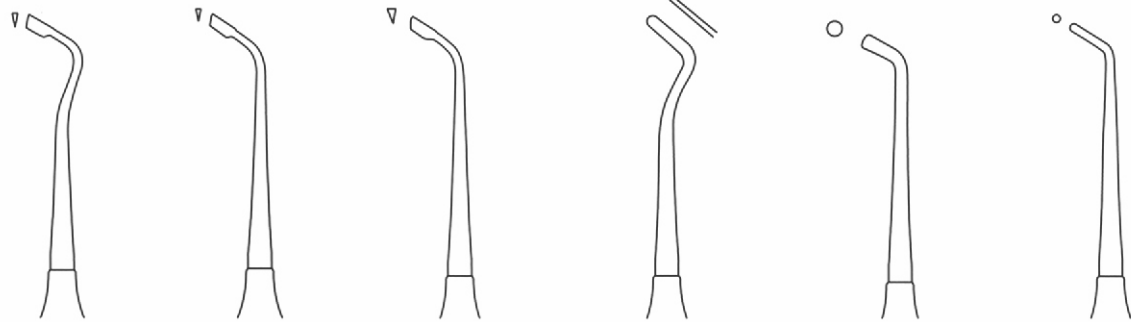
SS-60-2003
Fig. 3

SS-60-2004
Fig. 4

SS-60-2005
Fig. 5

SS-60-2006
Fig. 10

Note: Titanium Coated Points are available on customer demand.



SS-60-2007
 Fig. 1
 Felt

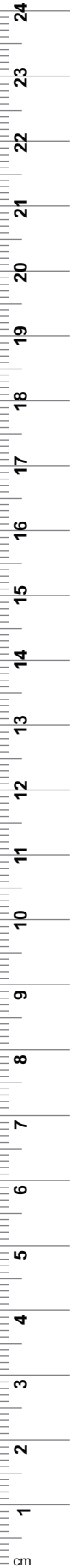
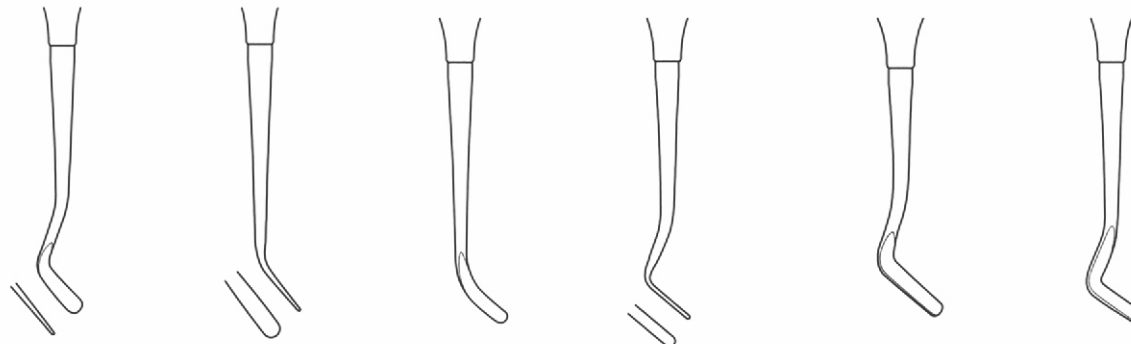
SS-60-2008
 Fig. 2
 Felt

SS-60-2009
 Fig. 3
 Felt

SS-60-2010
 Fig. 4
 Felt

SS-60-2011
 Fig. 5
 Felt

SS-60-2012
 Fig. 6
 Felt





SS-60-2013
Fig. 1
Goldstein



SS-60-2014
Fig. 2
Goldstein



SS-60-2015
Fig. 3
Goldstein



SS-60-2016
Fig. 4
Goldstein

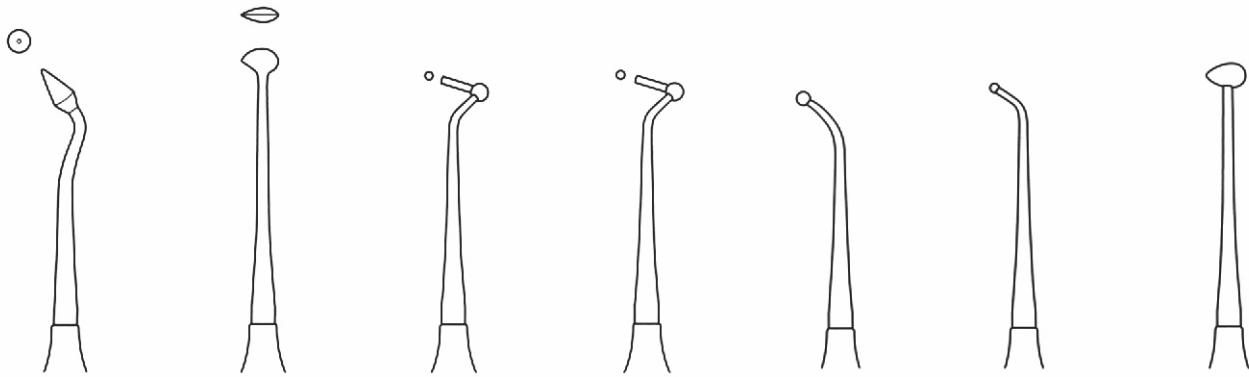


SS-60-2017
Fig. 9/10



SS-60-2018
Fig. 11/12





SS-60-2019
Fig. SB

SS-60-2020
Fig. 29/2B

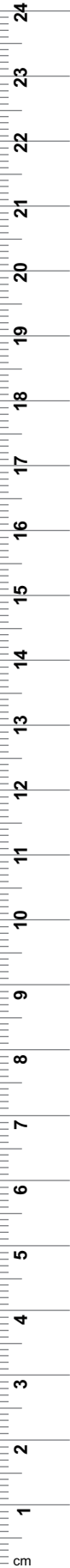
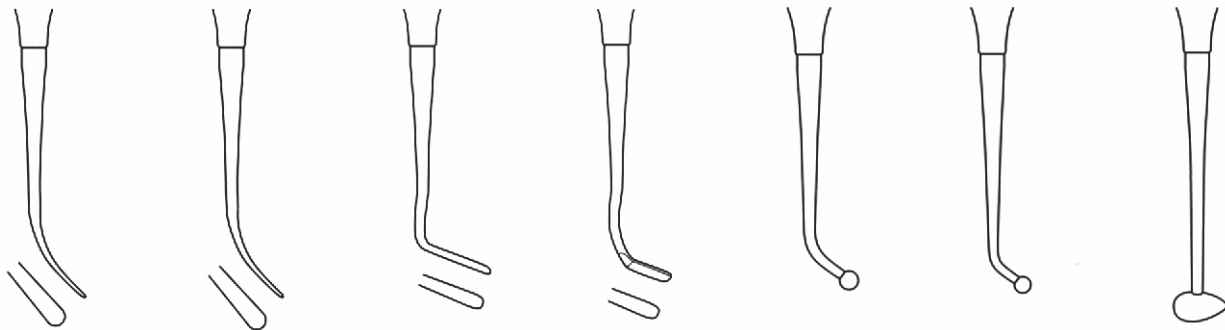
SS-60-2021
Fig. L1
Loesche

SS-60-2022
Fig. L2
Loesche

SS-60-2023
Fig. 18
Ball Burnisher

SS-60-2024
Fig. 26/27S
Ball Burnisher

SS-60-2025
Fig. 28/29
Ball Burnisher





SS-60-2026
Fig. 1S



SS-60-2027
Fig. 2S



SS-60-2028
Fig. 3S



SS-60-2029
Fig. 4S



SS-60-2030
Fig. 1P

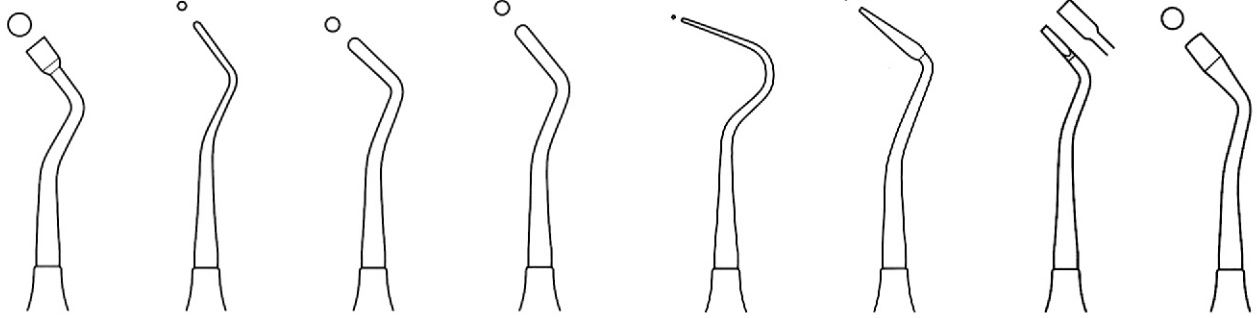


SS-60-2031
Fig. 2P

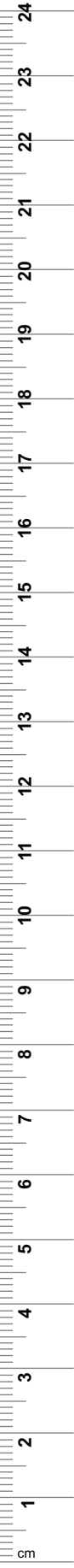
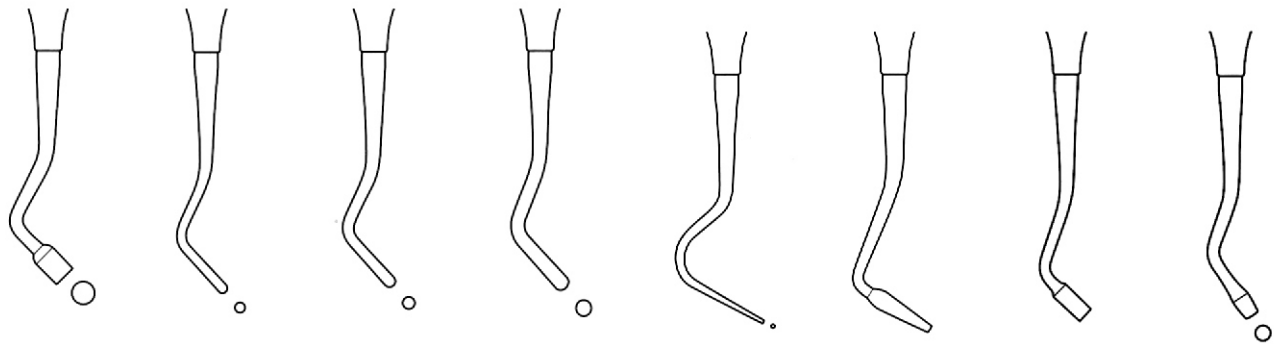


SS-60-2032
Fig. 3P





SS-60-2033 Fig. 4P SS-60-2034 Fig. 1D SS-60-2035 Fig. 2D SS-60-2036 Fig. 3D SS-60-2037 Fig. M1 Markley SS-60-2038 Fig. M2 SS-60-2039 Fig. M3 SS-60-2040 Fig. M4





SS-60-2041
Fig. M5



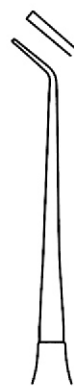
SS-60-2042
Fig. M6



SS-60-2043
Fig. H1
Hollenback



SS-60-2044
Fig. H2
Hollenback



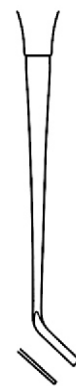
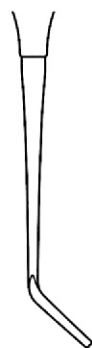
SS-60-2045
Fig. H3
Hollenback

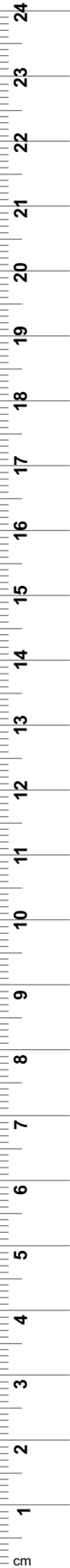
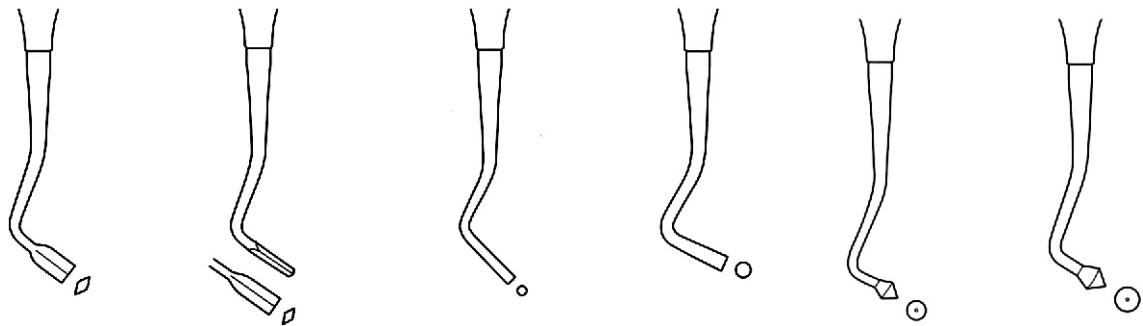
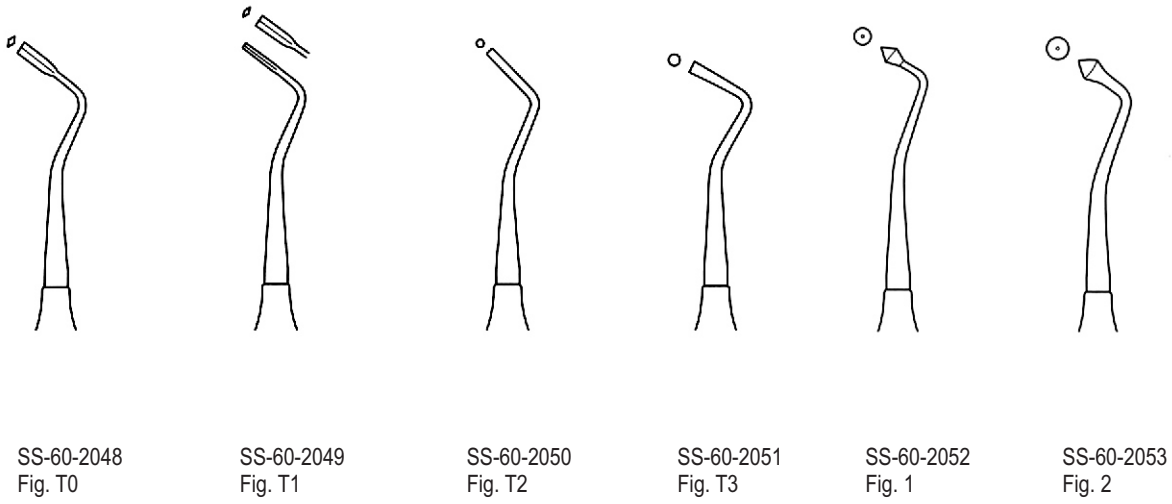


SS-60-2046
Fig. H4
Hollenback



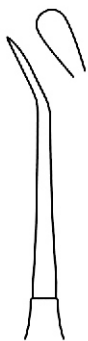
SS-60-2047
Fig. MQ 1S







SS-60-2054
Fig. 3



SS-60-2055
Fig. WO 1
Woodson



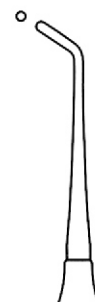
SS-60-2056
Fig. WO 2
Woodson



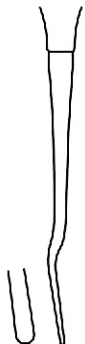
SS-60-2057
Fig. WO 3
Woodson

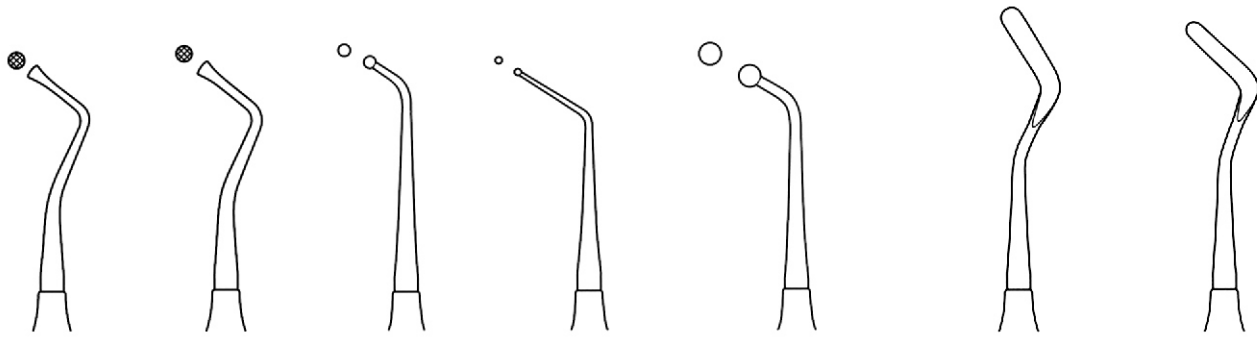


SS-60-2058
Fig. L2
Ladmore



SS-60-2059
Fig. L3
Ladmore





SS-60-2060
Fig. 1
Ward

SS-60-2061
Fig. 2
Ward

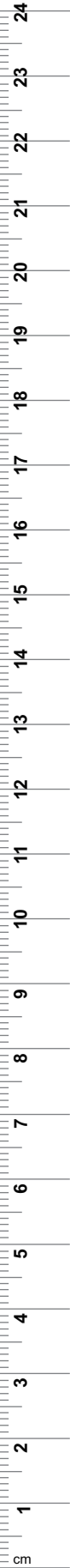
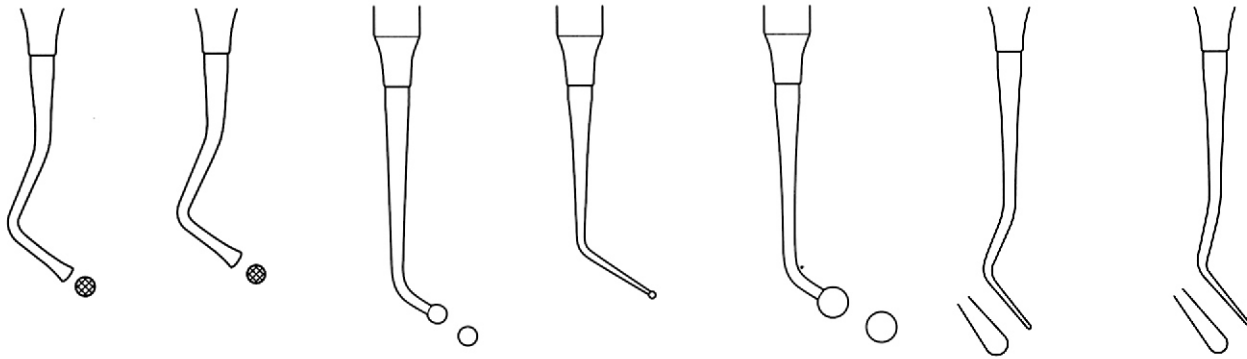
SS-60-2062
Fig. 7A

SS-60-2063
Fig. 19

SS-60-2064
Fig. 7B

SS-60-2065
Fig. 6

SS-60-2066
Fig. 11





SS-60-2067
Fig. 179



SS-60-2068
Fig. 1
2 mm



SS-60-2069
Fig. 2
2.5 mm



SS-60-2070
Fig. 3
3 mm



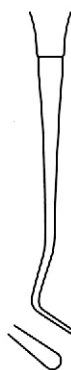
SS-60-2071
Fig. 11



SS-60-2072
Fig. 12



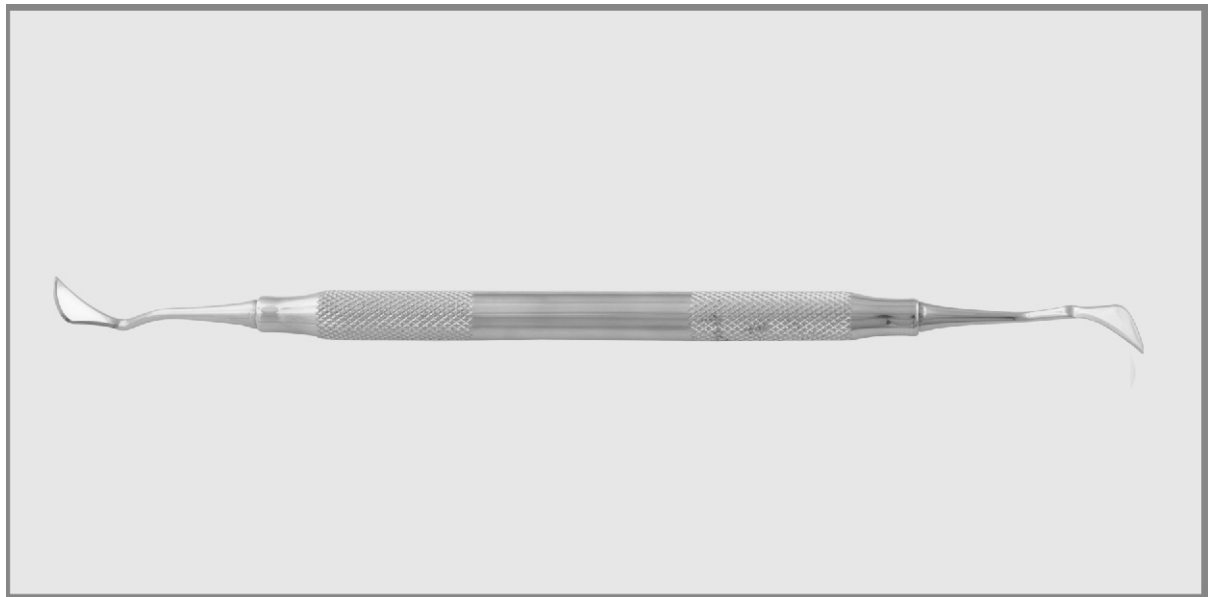
SS-60-2073
Fig. 13



61

- EN** Gingivectomy Knives
- DE** Gingivektomie Messer
- ES** Cuchillos de gingivectomía

Page 106 to 107



- EN —● Periodontal Knives
- DE —● Parodontale Messer
- ES —● Cuchillos periodontales

GINGIVECTOMY KNIVES



SS-61-2101
Goldman-Fox
Fig. 7



SS-61-2102
Goldman-Fox
Fig. 8



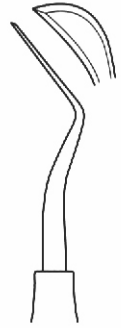
SS-61-2103
Goldman-Fox
Fig. 9



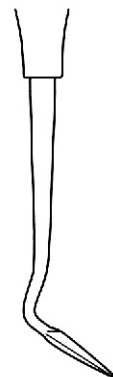
SS-61-2104
Goldman-Fox
Fig. 10



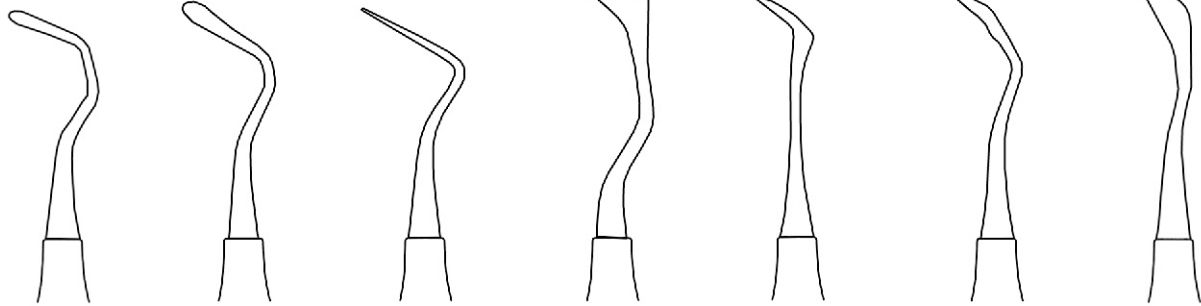
SS-61-2105
Goldman-Fox
Fig. 11



SS-61-2106
Kirkland
Fig. 15K/16K



Periodontal Knives ● EN
 Parodontale Messer ● DE
 Cuchillos periodontales ● ES



SS-61-2107
 Fig. 1
 Reddy Thin

SS-61-2108
 Fig. 2
 Reddy Thin

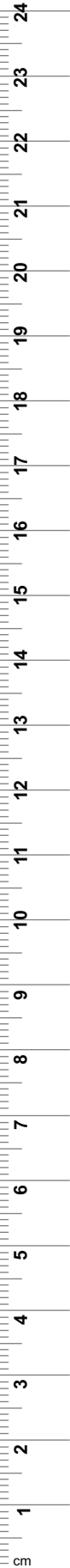
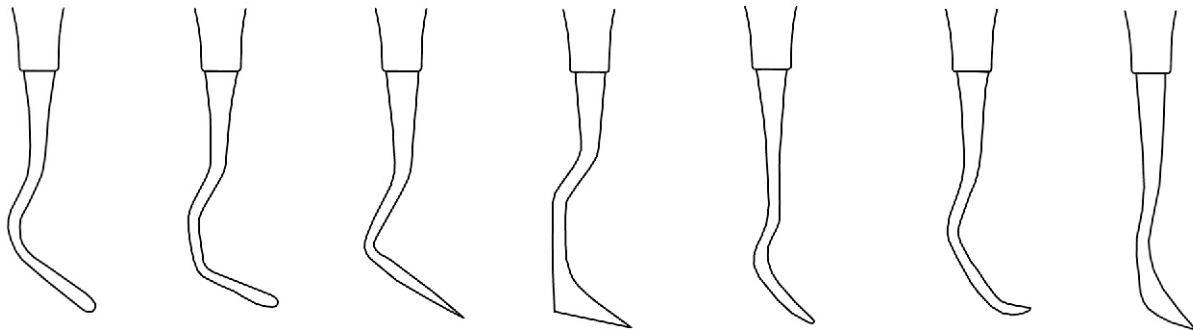
SS-61-2109
 Fig. 1/2
 Sanders

SS-61-2110
 Fig. 19/20
 USC Towner

SS-61-2111
 Fig. CK-3
 Crane Kaplan

SS-61-2112
 Fig. CK-6
 Crane Kaplan

SS-61-2113
 Fig. 1/2
 Solt

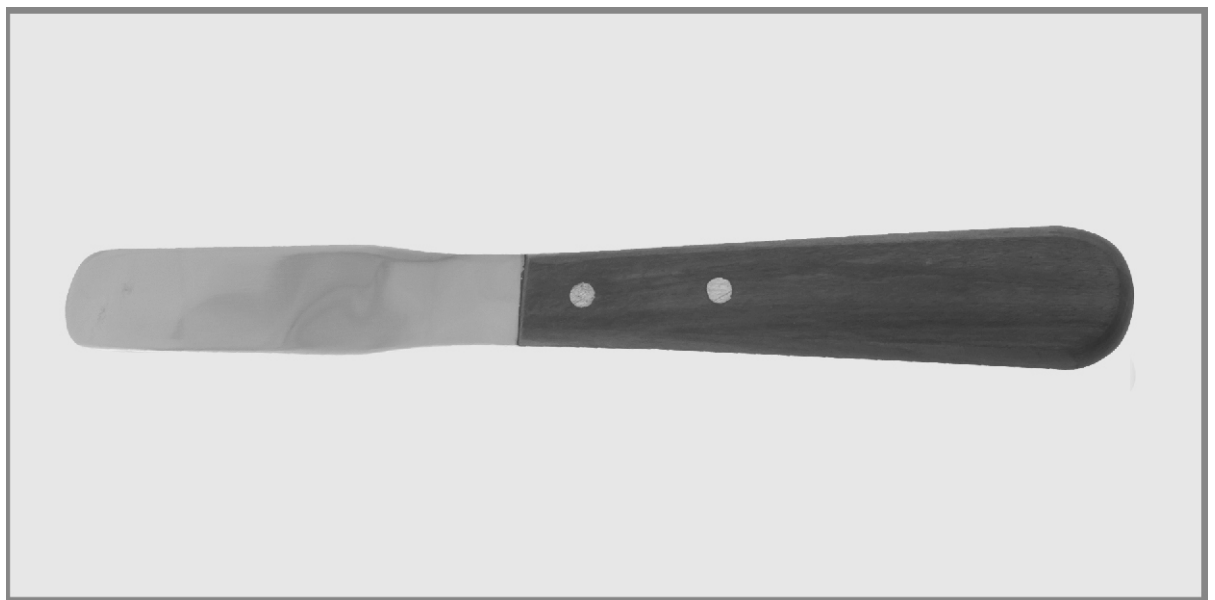


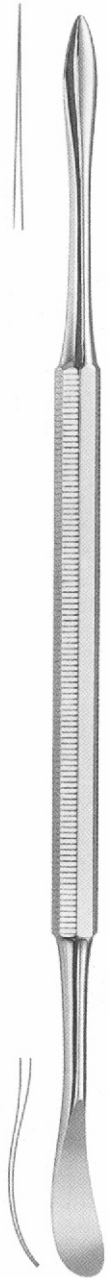


62

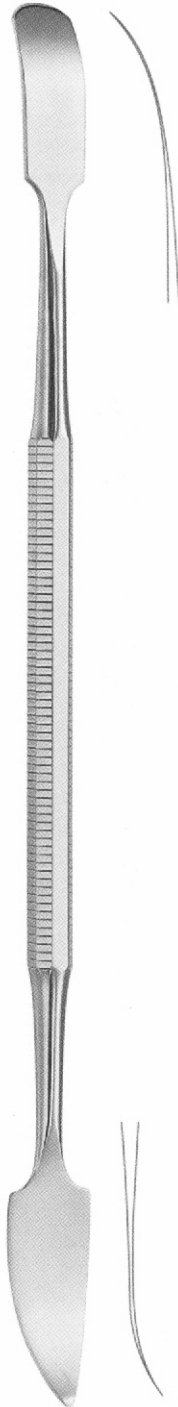
- EN** Cement Spatulas
- DE** Zementspatel
- ES** Espátulas de cemento

Page 108 to 112

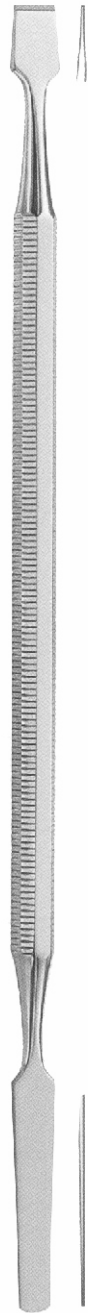




SS-62-2151
 Fig. 26
 Distal



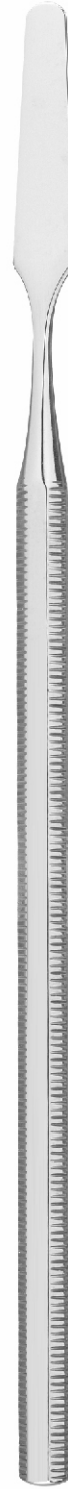
SS-62-2152
 Fig. 27
 Mesial



SS-62-2153
 Fig. 29
 Mesial



SS-62-2154
 Fig. 29
 Mesial



SS-62-2155
 Fig. 77/78
 Distal

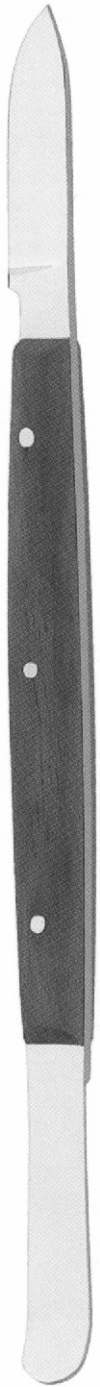


SS-62-2156
 Mesial
 54-1142-00



SS-62-2157
 Fig. 28
 Distal

Wooden Handle



SS-62-2158
 Fig. 28
 Distal



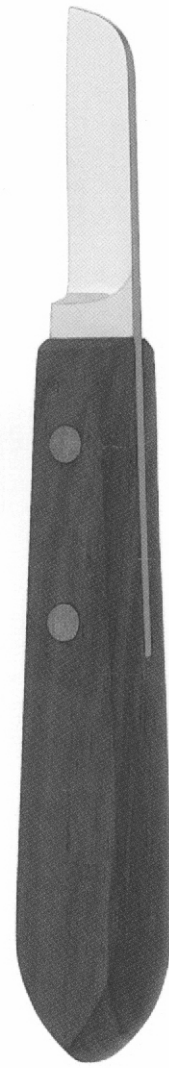
SS-62-2159
 Fig. 28
 Distal



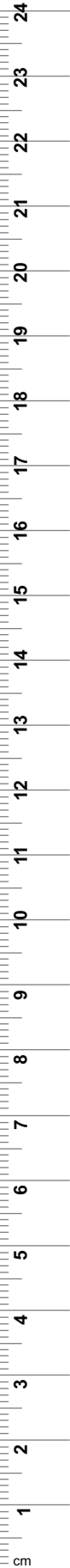
SS-62-2160
 Fig. 28
 Distal



SS-62-2161
 Fig. 28
 Distal



SS-62-2162
 Fig. 28
 Distal





SS-62-2163
Fig. 1



Fig. 2



Fig. 3



Fig. 4



Fig. 5

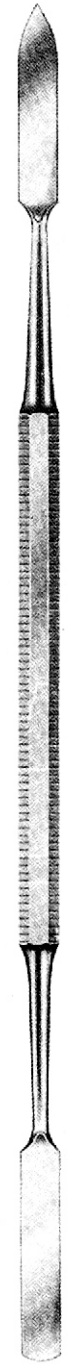


Fig. 1



Fig. 2
SS-62-2164

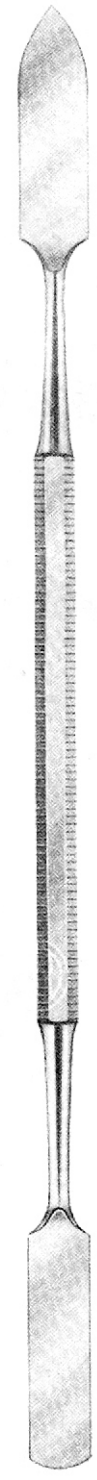
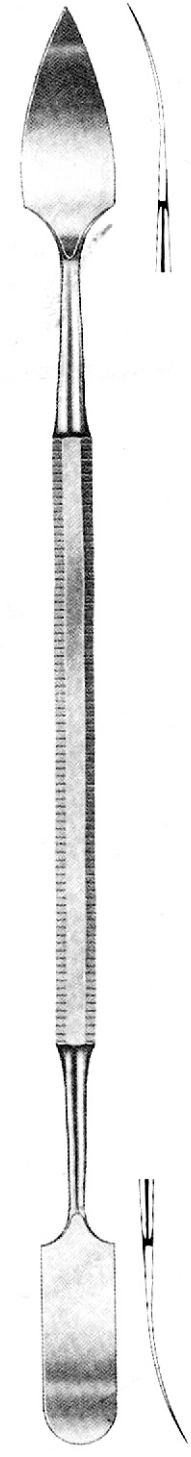
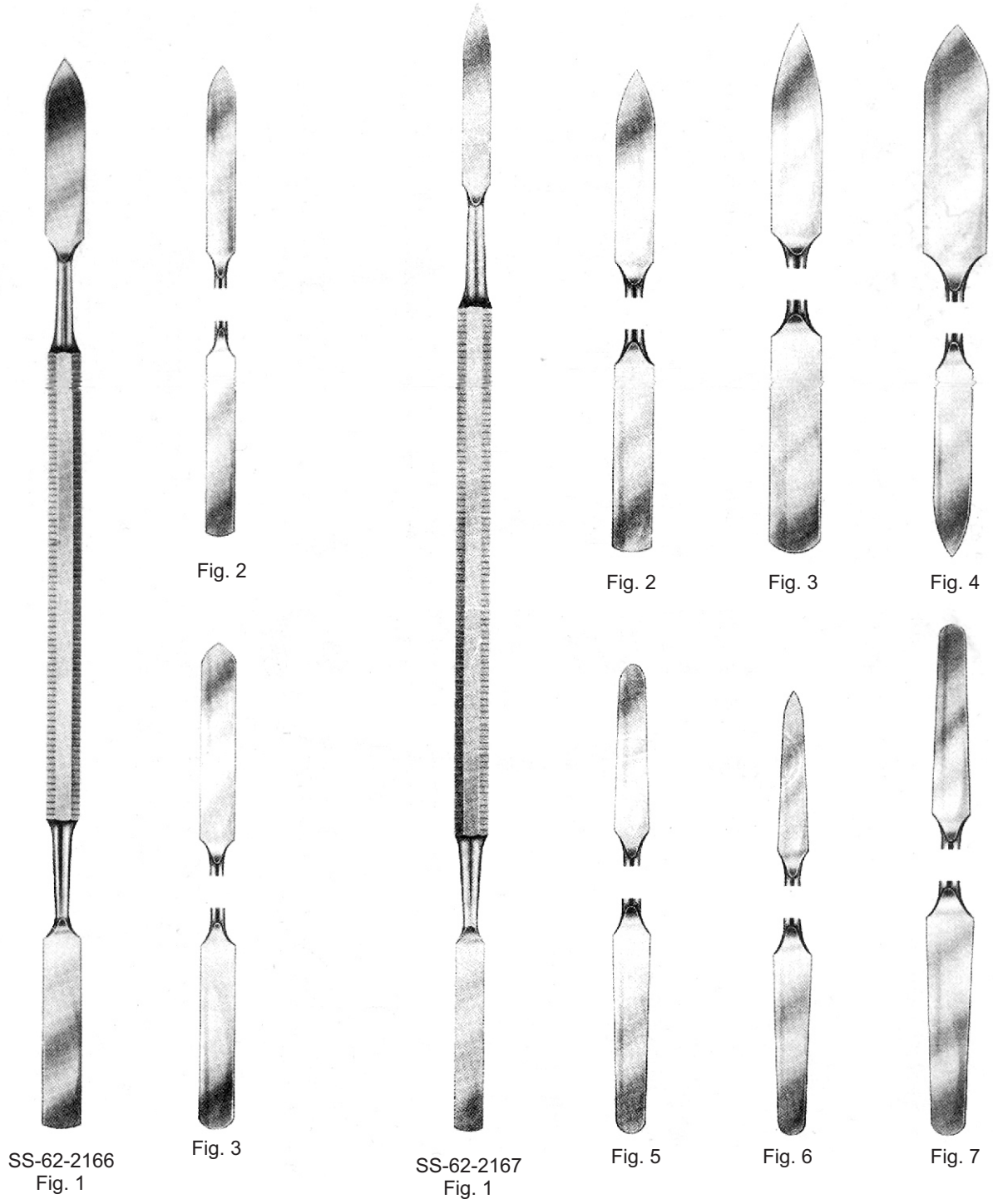


Fig. 3



SS-62-2165
Fig. 31
Gritman



SS-62-2166
Fig. 1

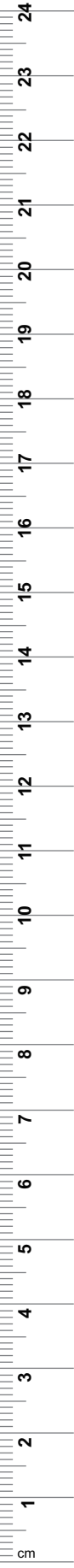
Fig. 3

SS-62-2167
Fig. 1

Fig. 5

Fig. 6

Fig. 7



EN —● Cement Spatulas
 DE —● Zementspatel
 ES —● Espátulas de cemento

CEMENT SPATULAS



SS-62-2168
Fig. 1



Fig. 2



Fig. 4



Fig. 5



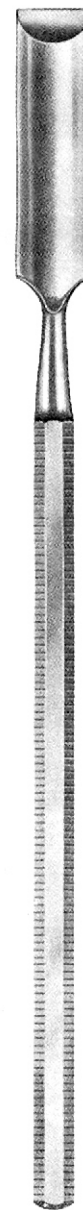
SS-62-2169
Fig. 313



Fig. 322



Fig. 324



SS-62-2170



Fig. 6



Fig. 7



Fig. 8



Fig. 5



Fig. 8



Fig. 24 A



Fig. 25 E



Fig. 11

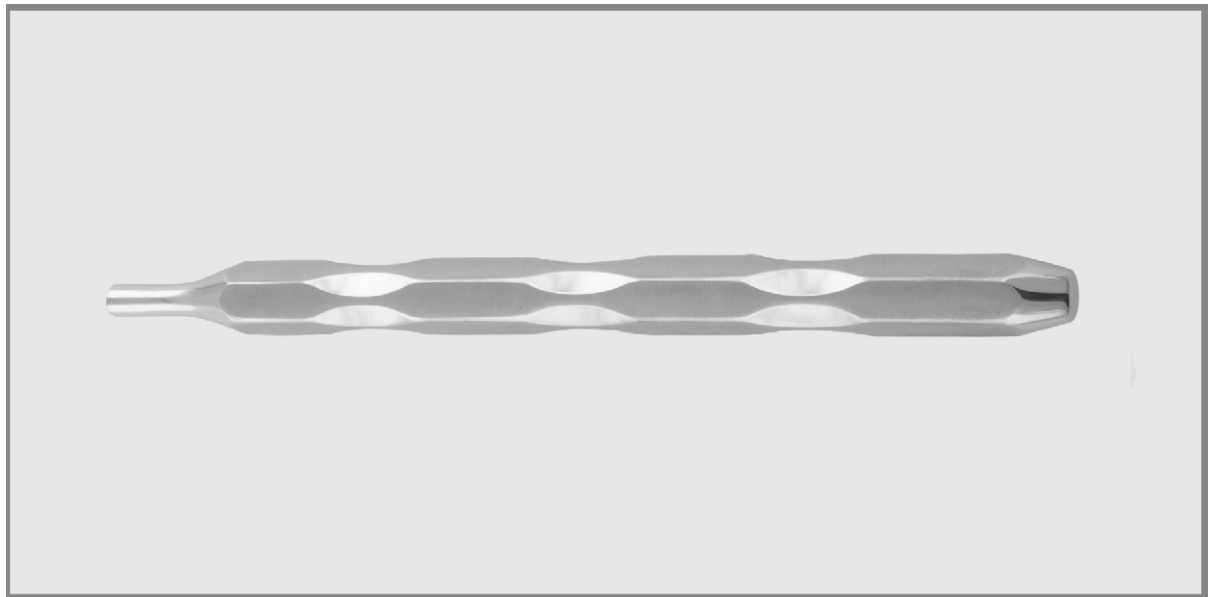


Fig. 12

63

- EN** Mouth Mirrors
- DE** Mundspiegel
- ES** Espejos bucales

Page 113 to 115





Simple Stem



Plain
Magnifying
Front Surface

1 = 16 mm
 3 = 20 mm
 4 = 22 mm
 5 = 24 mm

SS-63-2301-16
 SS-63-2301-20
 SS-63-2301-22
 SS-63-2301-24



Plain
Magnifying
Front Surface

4 = 22 mm
 5 = 24 mm

SS-63-2302-22
 SS-63-2302-24

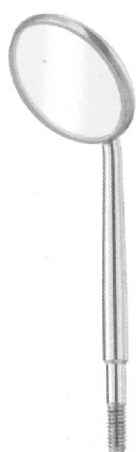


Plain
Magnifying
Front Surface

3 = 20 mm
 4 = 22 mm
 5 = 24 mm

SS-63-2303-20
 SS-63-2303-22
 SS-63-2303-24

Cone Socket



Plain
Magnifying
Front Surface

3 = 20 mm
 4 = 22 mm
 5 = 24 mm

SS-63-2304-20
 SS-63-2304-22
 SS-63-2304-24



Plain
Magnifying
Front Surface

3 = 20 mm
 4 = 22 mm
 5 = 24 mm

SS-63-2305-20
 SS-63-2305-22
 SS-63-2305-24

Mouth mirror handles ● EN
 Mundspiegelgriff ● DE
 Manches pour miroirs á bouche ● ES



SS-63-2306-01
 4,5 cm/13/4

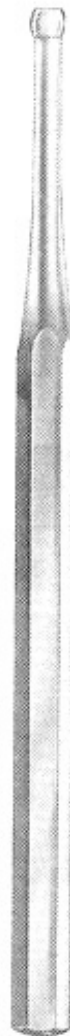


SS-63-2306-02
 Handle only

HILGER
 SS-63-2306-00
 18 cm/7"



SS-63-2307-14
 Hollow



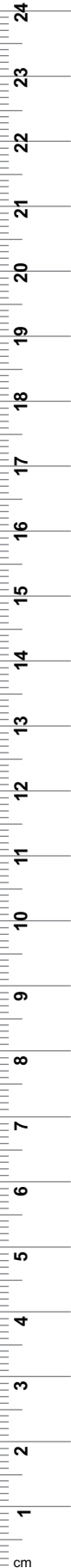
SS-63-2308-14
 Hollow



SS-63-2309-14
 Hollow



SS-63-2310-14
 Hollow



Mirror handles are available with Cone Socket and Simple Stem Fittings
 Matric / US Threads, Please specify while ordering

- EN — Mouth mirror handles
- DE — Mundspiegelgriff
- ES — Manchas para espejos de boca

MOUTH MIRRORS



SS-63-2311-12
Hollow



SS-63-2312-12
Solid



SS-63-2313-12
Solid



SS-63-2314-12
Solid



SS-63-2315-00
Solid



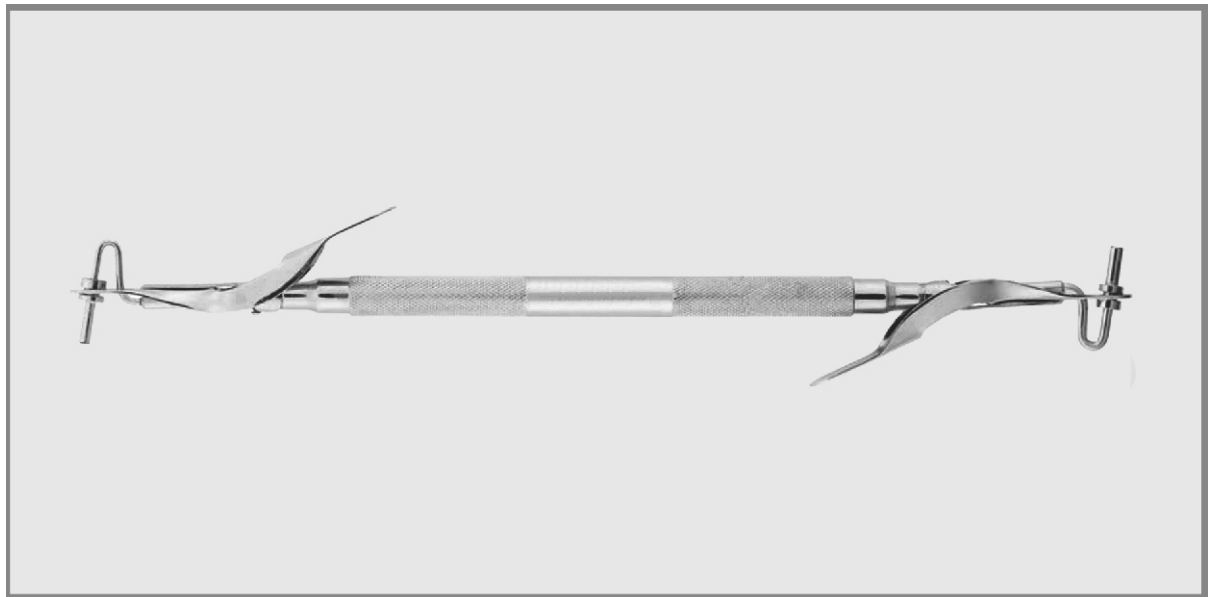
SS-63-2316-00
Hollow

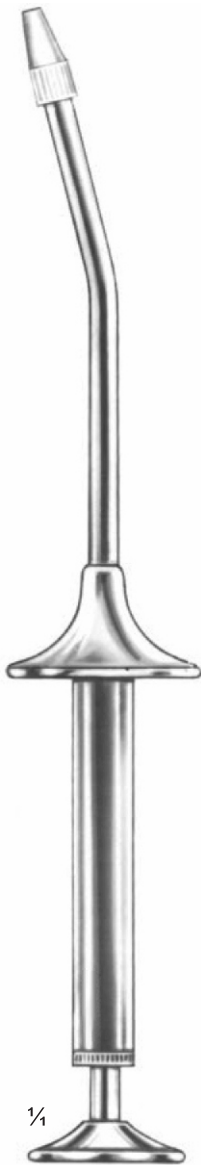
Mirror handles are available with Cone Socket and Simple Stem Fittings
Metric / US Threads, Please specify while ordering

64

- EN** Amalgam Instruments
- DE** Amalgam Instrumente
- ES** Instrumentos de amalgama

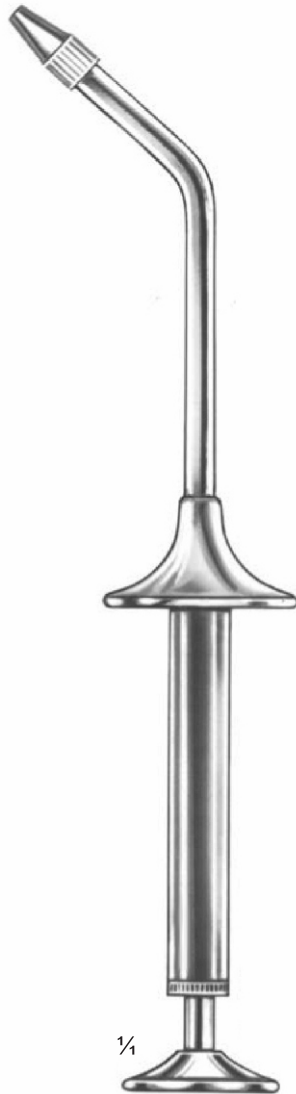
Page 116 to 117



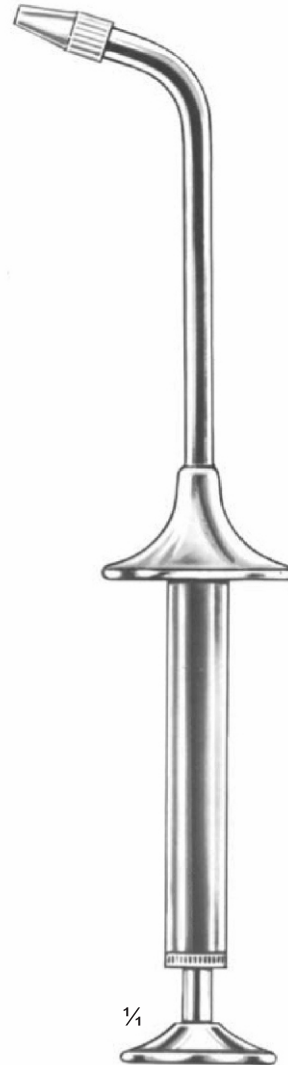


with metal tip
with plastic tip

SS-64-2351
SS-64-2352



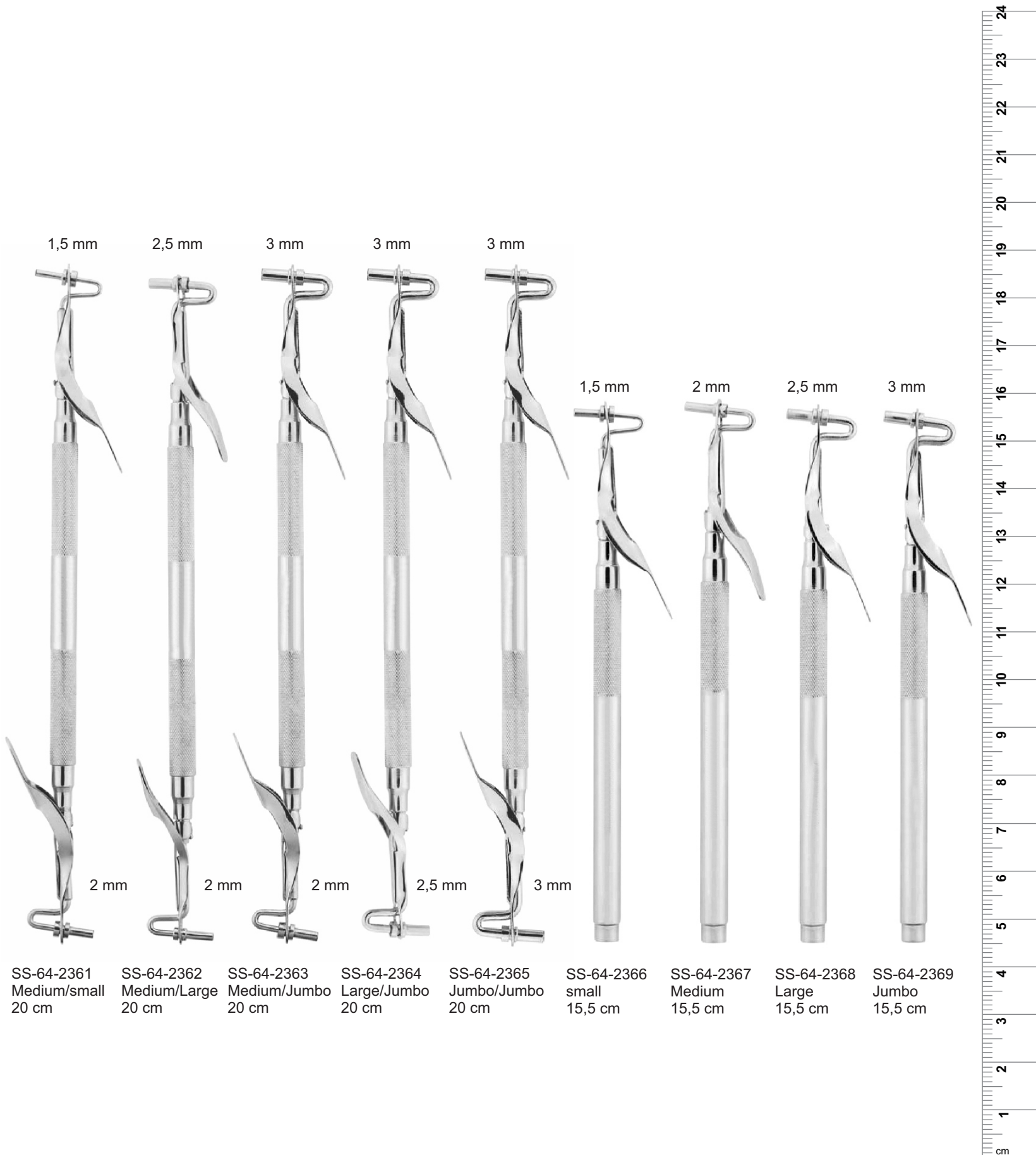
SS-64-2353
SS-64-2354



SS-64-2355
SS-64-2356



SS-64-2357
SS-64-2358



1,5 mm

2,5 mm

3 mm

3 mm

3 mm

1,5 mm

2 mm

2,5 mm

3 mm

2 mm

2 mm

2 mm

2,5 mm

3 mm

SS-64-2361
 Medium/small
 20 cm

SS-64-2362
 Medium/Large
 20 cm

SS-64-2363
 Medium/Jumbo
 20 cm

SS-64-2364
 Large/Jumbo
 20 cm

SS-64-2365
 Jumbo/Jumbo
 20 cm

SS-64-2366
 small
 15,5 cm

SS-64-2367
 Medium
 15,5 cm

SS-64-2368
 Large
 15,5 cm

SS-64-2369
 Jumbo
 15,5 cm

65

- EN** Matrix Retainers
- DE** Matrix-Halterungen
- ES** Retenedores de matrices

Page 118 to 125





Tofflemire-Universal
SS-65-2601



Tofflemire-Senior
SS-65-2602



Tofflemire-Junior
SS-65-2603



Fig.1
Nystrom
left
SS-65-2604



Fig.2
Nystrom
right
SS-65-2605



Ivory 8
SS-65-2606 5 mm
SS-65-2607 6 mm
SS-65-2608 7 mm

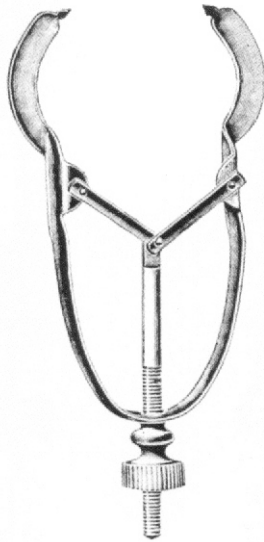


Ivory 8N
SS-65-2609

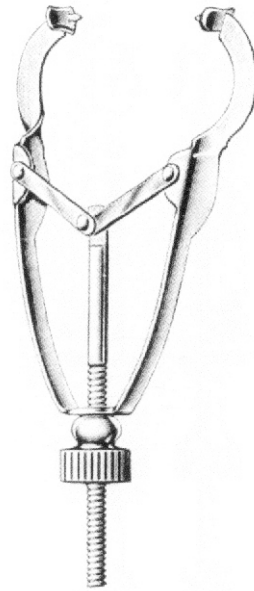


Didner 8P
SS-65-2610

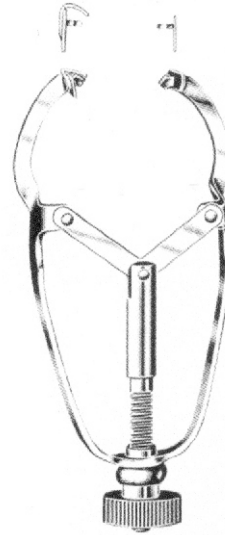
adjustable



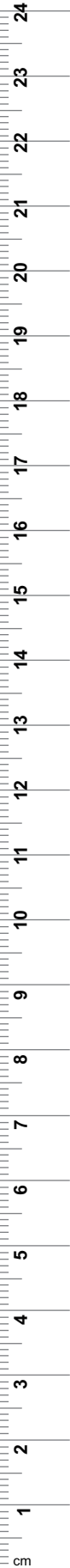
Ivory
SS-65-2611
Fig. 1



Ivory
SS-65-2612
Fig. 12



Ivory
SS-65-2613
Fig. 12A





Ainsworth
 SS-65-2614
 16 cm / 6 1/2"



Ainsworth
 SS-65-2615
 16 cm / 6 1/2"



Ivory
 SS-65-2616
 15 cm / 6"



Ivory
 SS-65-2617
 15 cm / 6"



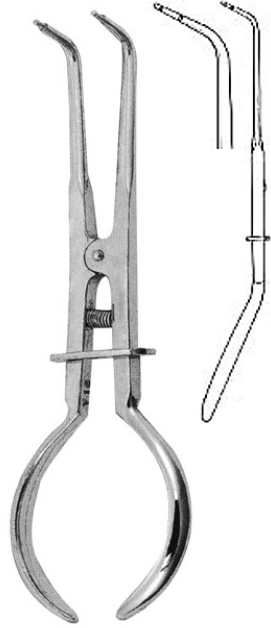
Ivory
 SS-65-2618
 17 cm / 6 3/4"



Brewer
 SS-65-2619
 17 cm / 6 3/4"



Stockes
 SS-65-2620
 17 cm / 6 3/4"



Stockes
 SS-65-2621
 17 cm / 6 3/4"



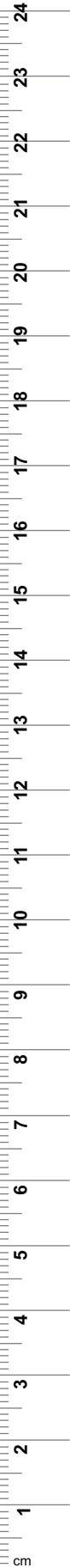
Palmer
 SS-65-2622
 17 cm / 6 3/4"



White
 SS-65-2623
 17 cm / 6 3/4"



Band Pusher-Mershon
 SS-65-2624
 14 cm / 5 1/2"





SS-65-2626
Fig. 00
Anterior Teeth



SS-65-2627
Fig. 0
Premolars



SS-65-2628
Fig. 1
Premolars



SS-65-2629
Fig. 1A
Premolars



SS-65-2630
Fig. 2
Premolars



SS-65-2631
Fig. 2A
Premolars



SS-65-2632
Fig. 2AS
Premolars



SS-65-2633
Fig. 3
Lower Molars



SS-65-2634
Fig. 4
Upper Molars



SS-65-2635
Fig. 5
Upper Molars



SS-65-2636
Fig. 6
Anterior Teeth



SS-65-2637
Fig. 7
Lower Molars



SS-65-2638
Fig. 7A
Lower Molars



SS-65-2639
Fig. 8
Upper Molars



SS-65-2640
Fig. 8A
Molars General



SS-65-2641
Fig. 9
Anterior Teeth



SS-65-2642
Fig. 9S
Anterior Teeth



SS-65-2643
Fig. 10
Molars General



SS-65-2644
Fig. 11
Molars General



SS-65-2645
Fig. 24
Molars General



SS-65-2646
Fig. 25
Molars General



SS-65-2647
Fig. 26
Lower Molars



SS-65-2648
Fig. 26N
Molars General



SS-65-2649
Fig. 27
Molars General



SS-65-2650
Fig. 27N
Premolars



SS-65-2651
Fig. 28
Lower Molars



SS-65-2652
Fig. 29
Lower Molars



SS-65-2653
Fig. 30
Upper Molars



SS-65-2654
Fig. 31
Upper Molars



SS-65-2655
Fig. 56
Molars General



SS-65-2656
Fig. 56S
Molars General



SS-65-2657
Fig. 201
Upper Molars



SS-65-2658
Fig. 205
Upper Molars



SS-65-2659
Fig. 212
Anterior Teeth



SS-65-2660
Fig. 212SA
Anterior Teeth



SS-65-2661
Premolars
12-06SS-65-W2



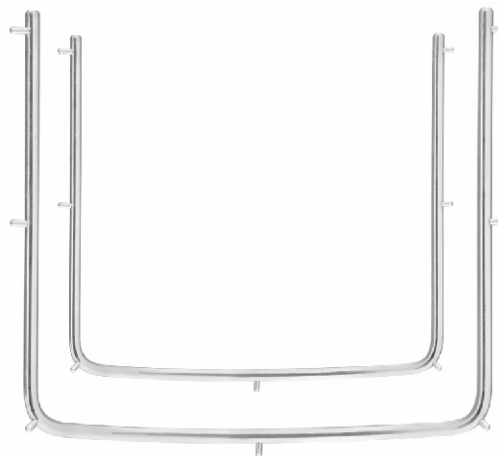
SS-65-2662
Fig. W3
Lower Molars



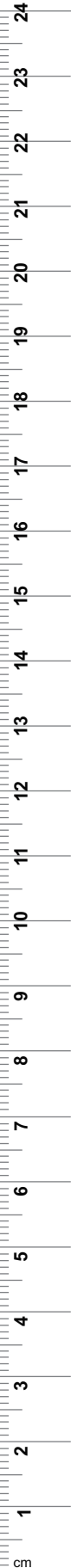
SS-65-2663
Fig. W4
Upper Molars

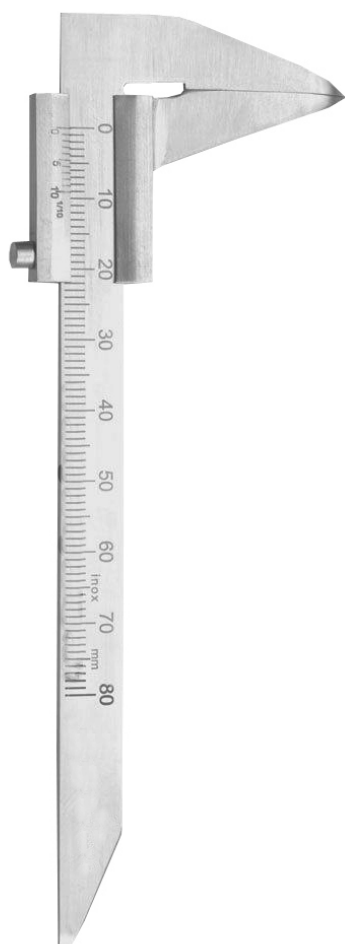


SS-65-2664
Fig. W7
Lower Molars

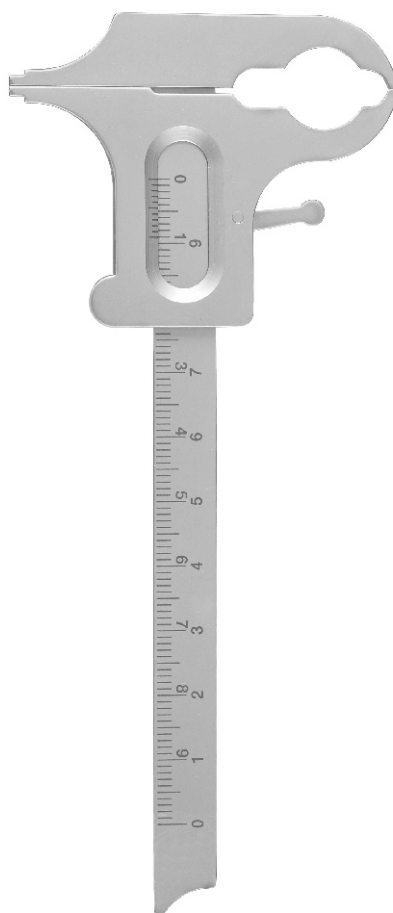


SS-65-2665 Frame - Child
13 cm/5"
 SS-65-2666 Frame - Adult
15 cm/6"





SS-65-2667
Beerendonk

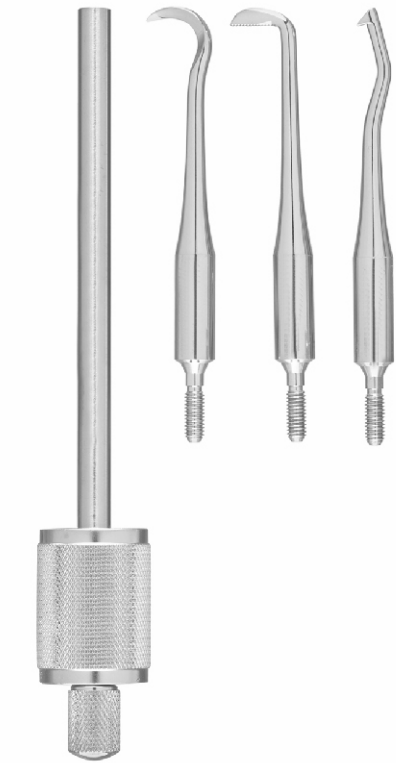


SS-65-2668
Boley



Iwanson
One side graugation
SS-65-2669 Metal
SS-65-2670 Wax

Double side graugation
SS-65-2671 Metal
SS-65-2672 Wax



SS-65-2673
 Morrel
 Crown Remover



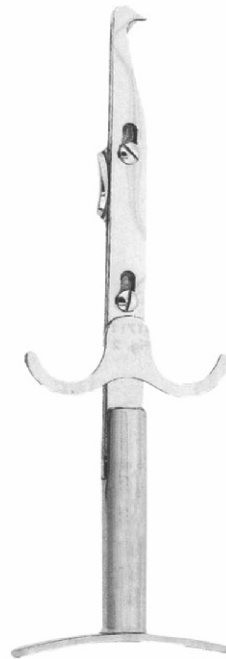
SS-65-2674
 Crown Remover
 Manual



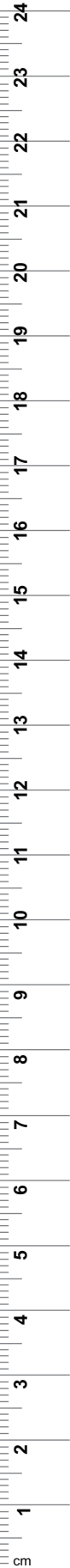
SS-65-2675
 Crown Remover
 Manual



SS-65-2676
 Crown Remover
 Automatic



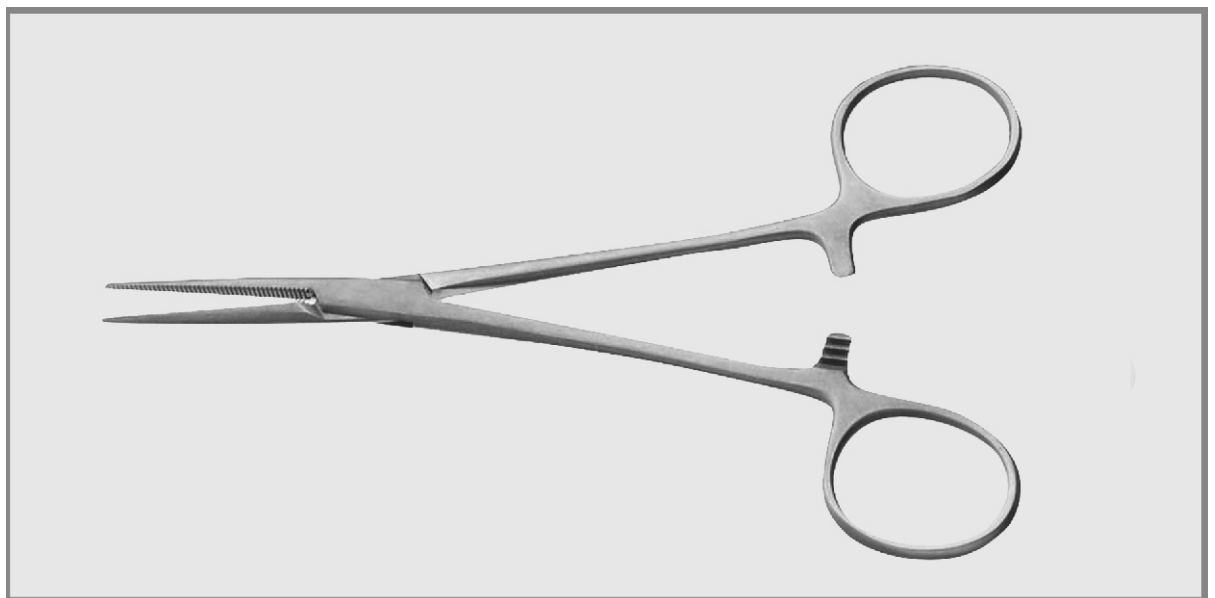
SS-65-2677
 Crown Remover
 Automatic



66

- EN** Hemostatic Forceps
- DE** Arterienklemmen
- ES** Pincas hemostaticas

Page 126 to 132


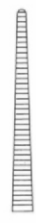


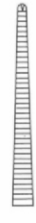




EN —●— Artery Forceps
 DE —●— Arterienklemmen
 ES —●— Pinzas hemostáticas

ARTERY FORCEPS



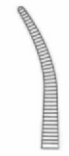
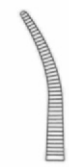


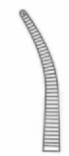



Halsted-Mosquito

			
SS-66-2701 12.5 cm/5"	SS-66-2702 14.5 cm/5 ¾"	SS-66-2703 14 cm/5 ½"	
			
SS-66-2704 12.5 cm/5" 1:2	SS-66-2705 14.5 cm/5 ¾" 1:2	SS-66-2706 12 cm/4 ¾" 1:2	SS-66-2707 14 cm/4 ½" 1:2



Micro-Mosquito

			
SS-66-2708 10 cm/4"	SS-66-2709 12 cm/4 ¾"	SS-66-2710 9.5 cm/3 ½"	SS-66-2711 11.5 cm/4 ½"
			
SS-66-2712 10 cm/4" 1:2	SS-66-2713 12 cm/4 ¾" 1:2	SS-66-2714 10 cm/4" 1:2	SS-66-2715 12 cm/4 ¾" 1:2

ARTERY FORCEPS



Halsted-Mosquito



SS-66-2716
18 cm/7"



SS-66-2717
18 cm/7"



SS-66-2718
18 cm/7"
1:2



SS-66-2719
18 cm/7"
1:2



Leriche



SS-66-2720
15 cm/6"



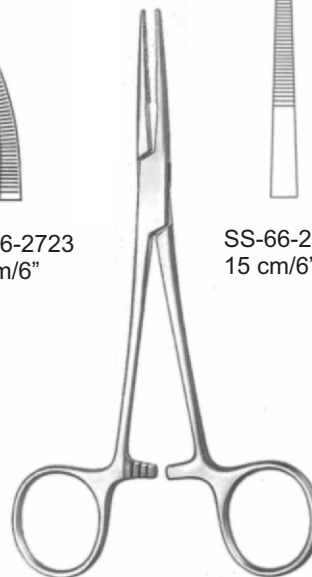
SS-66-2721
15 cm/6"



SS-66-2722
15 cm/6"
1:2



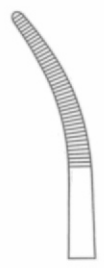
SS-66-2723
15 cm/6"
1:2



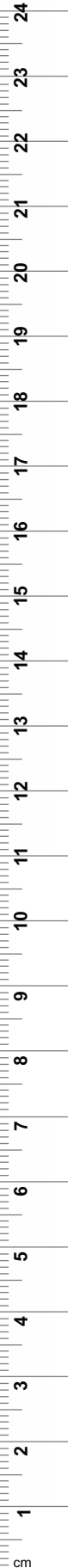
Kelly

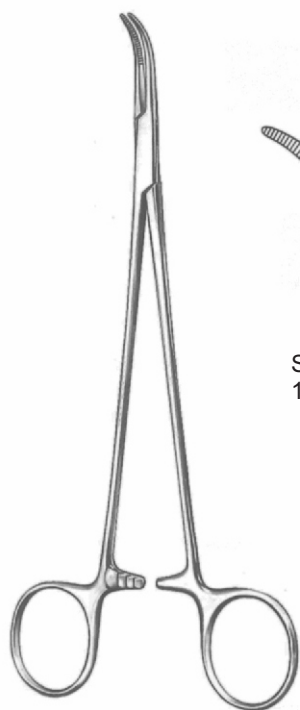


SS-66-2724
15 cm/6"



SS-66-2725
15 cm/6"

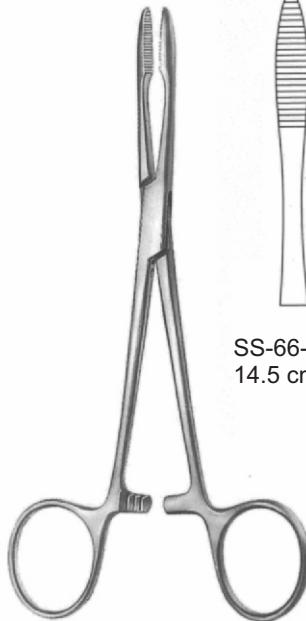




Mixer-Baby



SS-66-2726
18.5 cm/7 1/4"



Pean



SS-66-2727
14.5 cm/5 3/4"



SS-66-2728
16 cm/6 1/4"



Pean



SS-66-2729
13 cm/5"



SS-66-2730
14 cm/5 1/2"



SS-66-2731
17 cm/6 3/4"



SS-66-2732
13 cm/5"

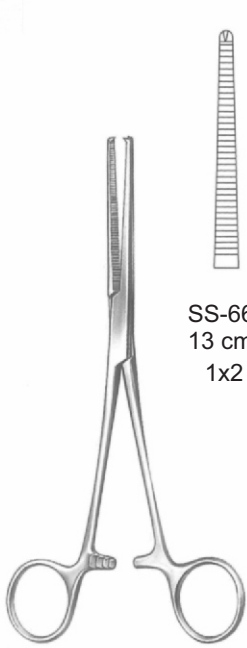


SS-66-2733
14 cm/5 1/2"



SS-66-2734
17 cm/6 3/4"

ARTERY FORCEPS



Kocher

SS-66-2735
 13 cm/5"
 1x2



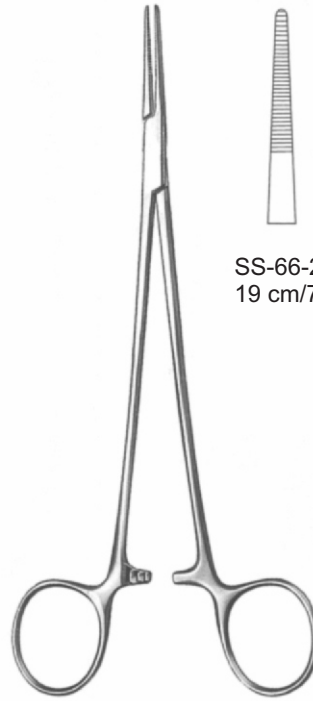
SS-66-2736
 14 cm/5 1/2"
 1x2



SS-66-2737
 13 cm/5"
 1x2

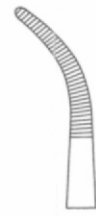


SS-66-2738
 14 cm/5 1/2"
 1x2



Adson

SS-66-2739
 19 cm/7 1/2"



SS-66-2740
 19 cm/7 1/2"



Gross-Maier



SS-66-2741
 20 cm/8"



SS-66-2742
 20 cm/8"



DeBakey-Mosquito

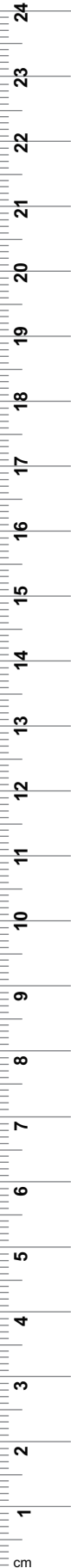
ATRAUMA



SS-66-2743
 12.5 cm/5"

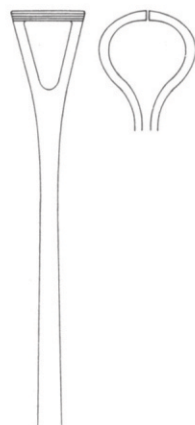


SS-66-2744
 12.5 cm/5"





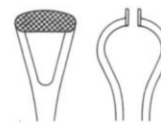
Babcock



SS-66-2745 16 cm/6 1/4"
 SS-66-2746 18 cm/7 1/8"
 SS-66-2747 20 cm/7 7/8"
 SS-66-2748 24 cm/9 1/2"



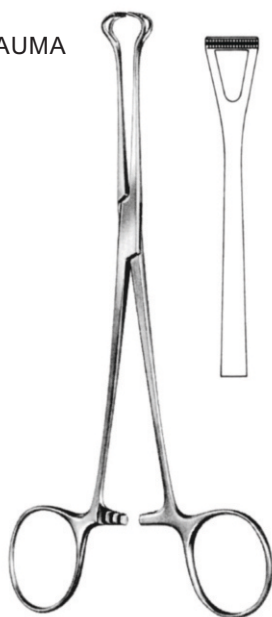
Babcock



SS-66-2749 TC
 16 cm/6 1/2"

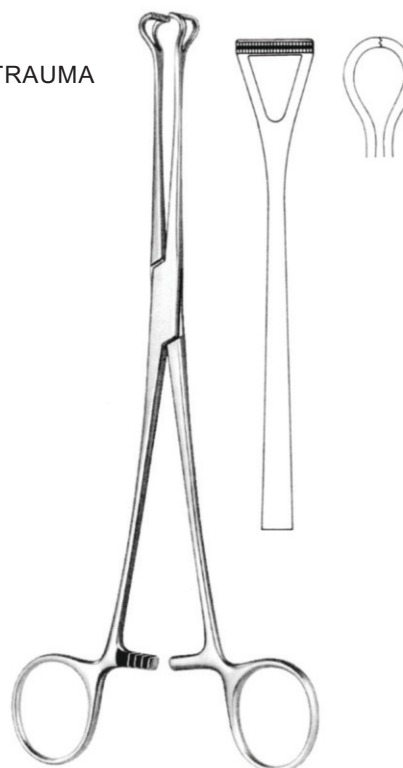


ATRAUMA

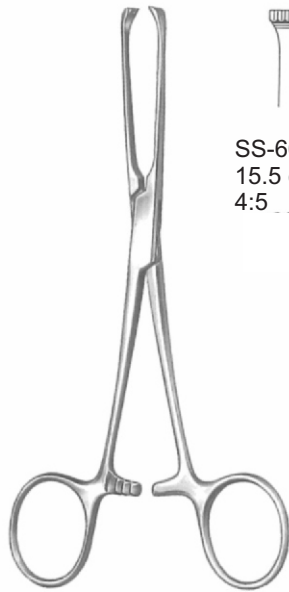


BABCOCK
 SS-66-2750
 16 cm/9 1/4"

ATRAUMA



BABCOCK
 SS-66-2751
 20.5 cm/8 1/8"



Allis



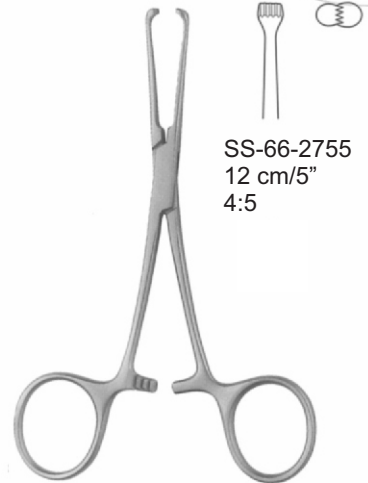
SS-66-2752
 15.5 cm/6"
 4:5



SS-66-2753
 15.5 cm/6"
 5:6



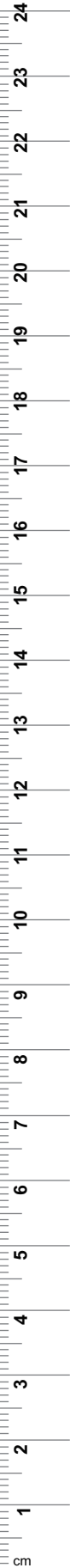
SS-66-2754
 19 cm/7 1/2"
 5:6



Allis-Baby



SS-66-2755
 12 cm/5"
 4:5



- EN —● Artery Forceps
- DE —● Arterienklemmen
- ES —● Pinzas hemostáticas

ARTERY FORCEPS



ATRAUMA



Allis



SS-66-2756
16 cm/6 1/2"

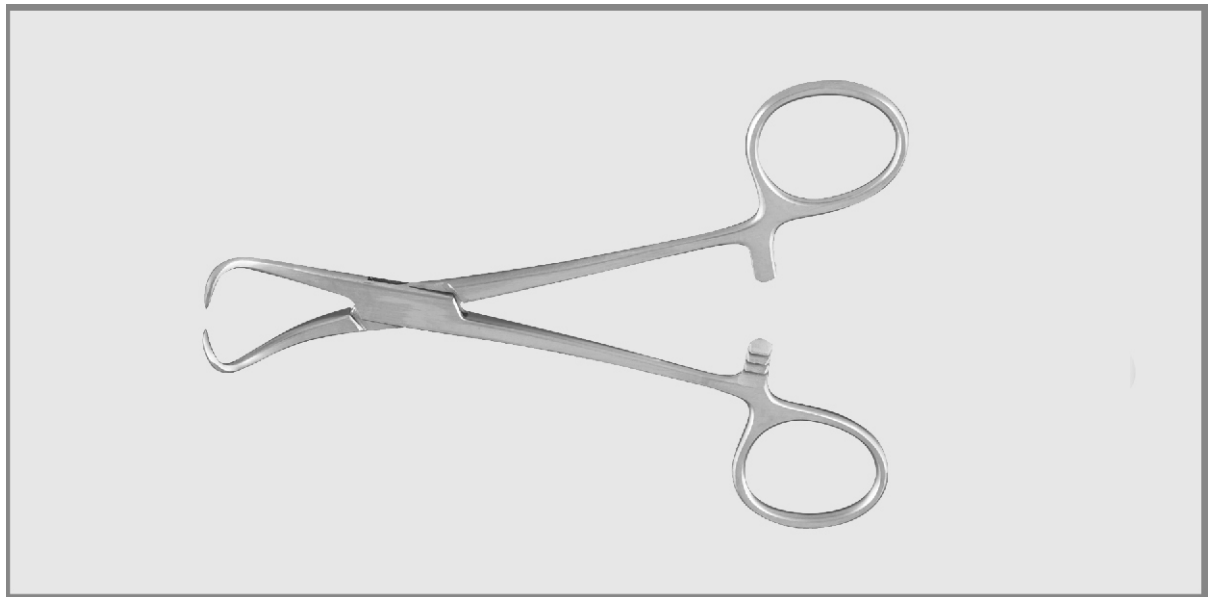


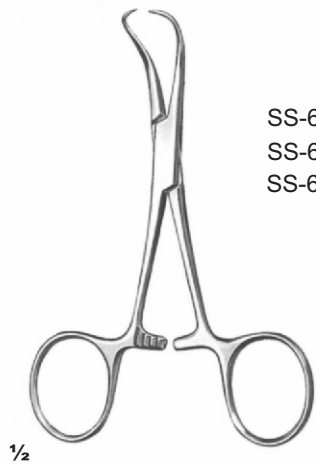
SS-66-2757
20 cm/8"

67

- EN** Towel Clamps
- DE** Handtuchklammern
- ES** Abrazaderas de toalla

Page 133 to 134





1/2

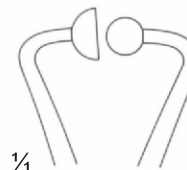
Backhaus

SS-67-2801 9 cm/3 1/2"
 SS-67-2802 11.5 cm/4 1/2"
 SS-67-2803 13 cm/5"



1/2

for paper clothes



1/4

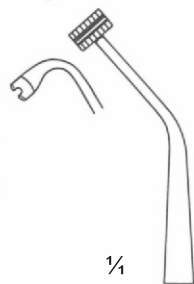
SS-67-2804
 11.5 cm/4 1/2"

SS-67-2805
 14 cm/5 1/2"

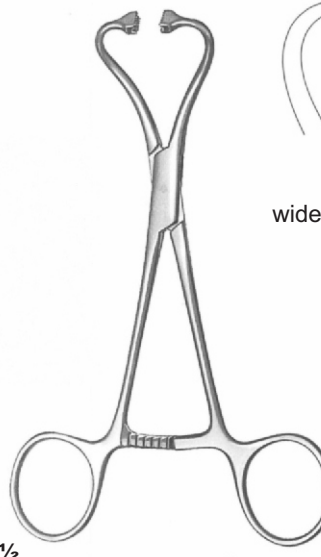


1/2

Peers-Bertram
 SS-67-2806
 14.5 cm/5 3/4"

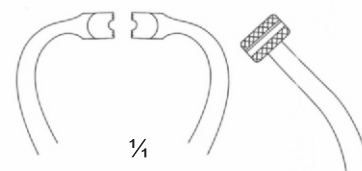


1/4



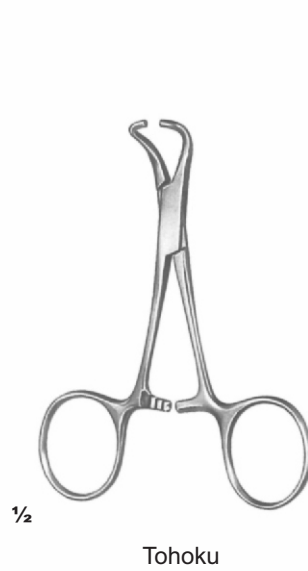
1/2

Peers-Bertram modif.
 SS-67-2807
 15.5 cm/6"



1/4

wide jaw for tube fixation



SS-67-2808
10.5 cm/4"

SS-67-2809
13.5 cm/5 1/4"

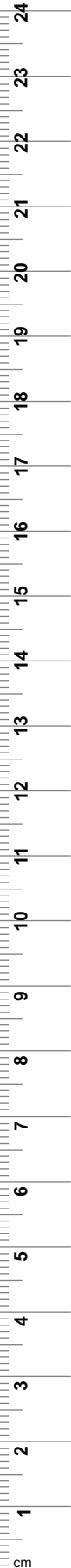


Schadel
SS-67-2810
8.5 cm/3 1/2"
sharp



Jones
sharp

SS-67-2811
8.5 cm/3 1/4"

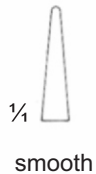
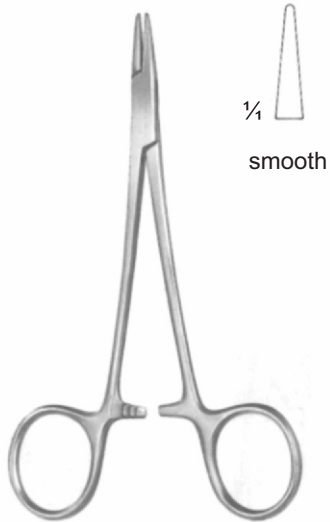


68

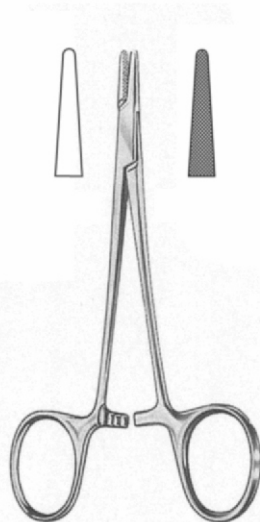
- EN** Needle Holders
- DE** Nadelhalter
- ES** Porte-aiguilles

Page 135 to 143





Webster
 SS-68-2901
 13 cm/5 1/8"



Halsey
 SS-68-2902 13 cm/5 1/8" Plain
 SS-68-2903 13 cm/5 1/8" Serrated



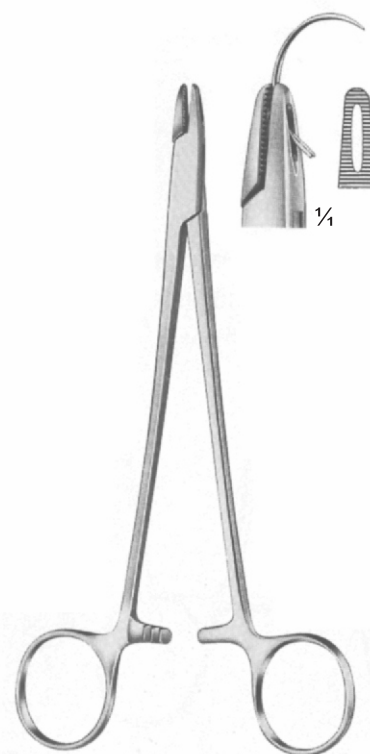
Derf
 SS-68-2904
 12 cm/4 3/4"
 one feestrated jaw



Crile-Wood
 SS-68-2905
 15 cm/5 7/8"

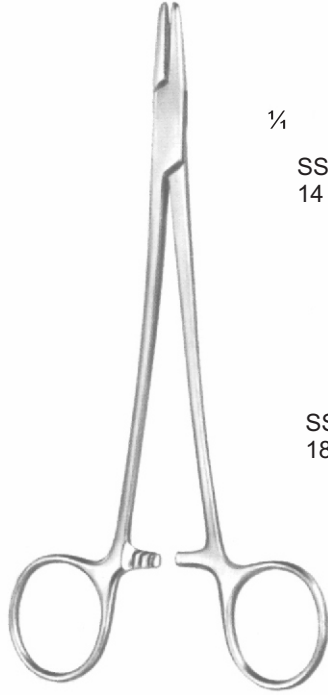


Crile-Murray
 SS-68-2906
 15 cm/5 7/8"
 slender pattern



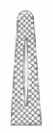
Adson
 SS-68-2907
 18 cm/7 1/8"
 one fenestrated jaw

Needle Holders — EN
 Nadelhalter — DE
 Porta agujas — ES

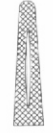


MAYO-HEGAR

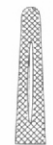
1/4



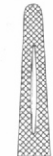
SS-68-2908
14 cm/5 1/2"



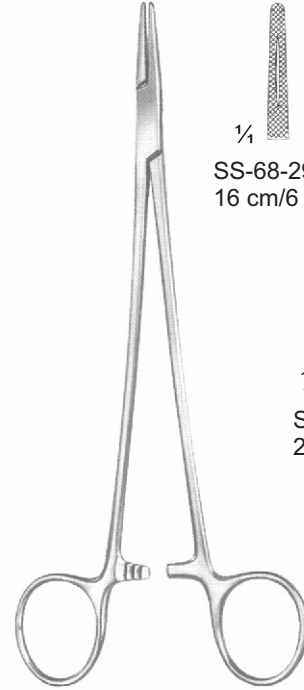
SS-68-2909
16 cm/6 1/4"



SS-68-2910
18.5 cm/7 1/4"

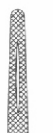


SS-68-2911
20.5 cm/8 1/8"

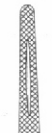


MAYO-HEGAR
slender pattern

1/4

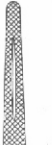


SS-68-2912
16 cm/6 1/4"



SS-68-2913
19 cm/7 1/2"

1/4



SS-68-2914
20.5 cm/8 1/8"



HEGAR-BAUMGARTNER
SS-68-2915
14 cm/5 1/2"



MATHIEU

1/4



SS-68-2916
14 cm/5 1/2"



SS-68-2917
17 cm/6 3/4"

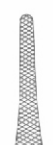


SS-68-2918
20 cm/7 7/8"

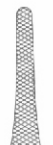


MATHIEU
slender pattern

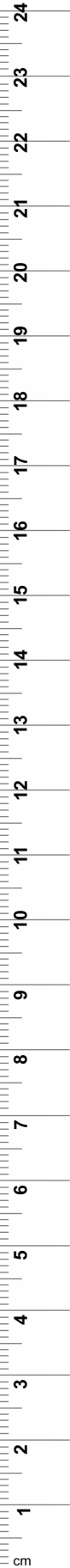
1/4



SS-68-2919
14 cm/5 1/2"



SS-68-2920
17 cm/6 3/4"





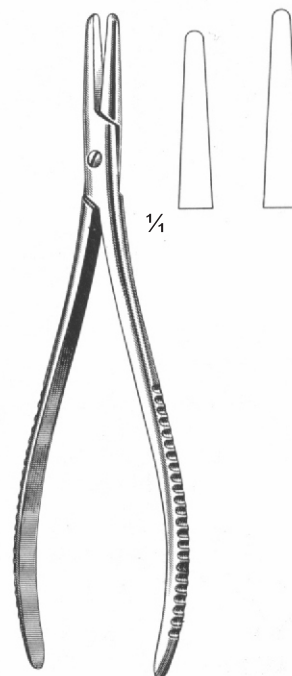
Lichtenberg
 SS-68-2921
 20 cm/7 7/8"



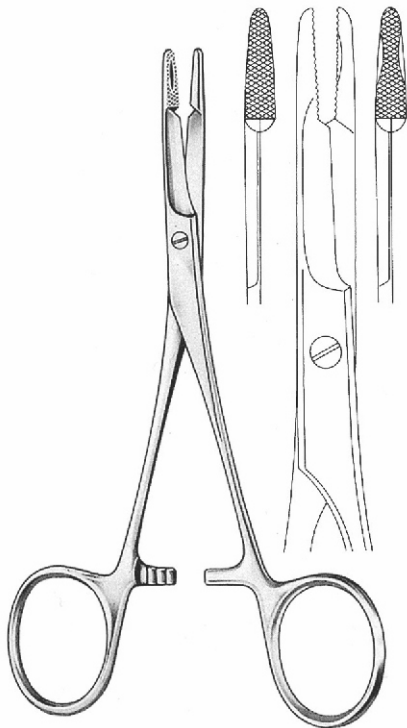
Toennis
 SS-68-2922
 18.5 cm/7 1/4"



Crile
 SS-68-2923
 15 cm/5 7/8"

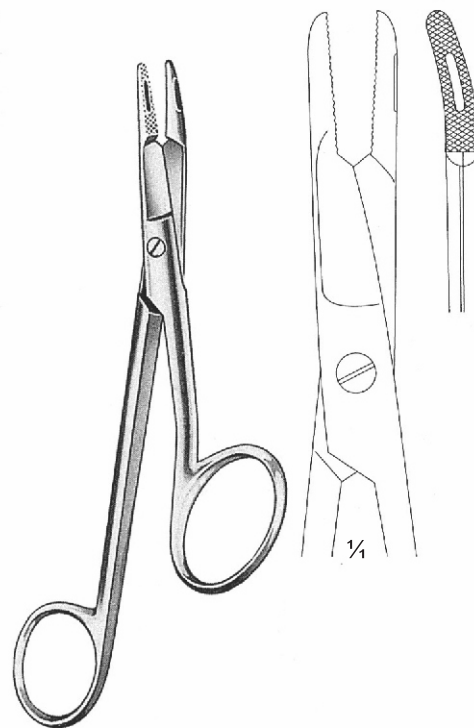


Langenbeck
 SS-68-2924 16 cm/6 1/4"
 SS-68-2925 20 cm/7 7/8"



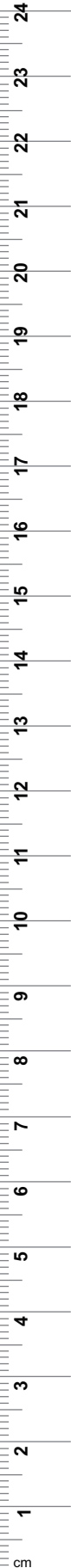
Olsen-Hegar

- SS-68-2926 11 cm/4 3/8"
- SS-68-2927 14 cm/5 1/2"
- SS-68-2928 18 cm/7 1/8"
- SS-68-2929 19 cm/7 1/2"



Gillies

- SS-68-2930 Right hand
- SS-68-2931 Left hand
- 16 cm/6 1/4"





HALSEY



SS-68-2932
 13 cm/5 1/8
 smooth jaw



SS-68-2933
 13 cm/5 1/8
 0.4 mm



WEBSTER
 12.5 cm/4 7/8"



SS-68-2934
 smooth jaw



SS-68-2935
 0.4 mm



DERF
 SS-68-2936
 12 cm/4 3/4"



0.4 mm



Toennis
 SS-68-2937
 18 cm/7 1/8



0.5 mm



Langenbeck



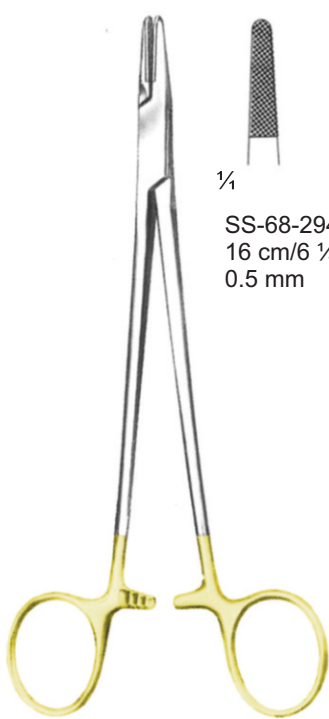
0.5 mm
 SS-68-2938
 18.5 cm/7 1/4"



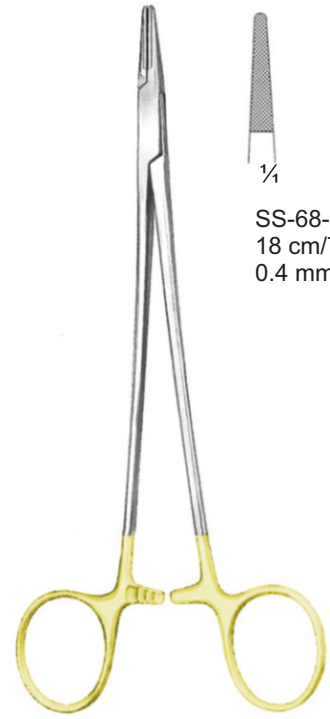
0.5 mm
 SS-68-2939
 20.5 cm/8 1/8



0.5 mm
 SS-68-2940
 23 cm/9"



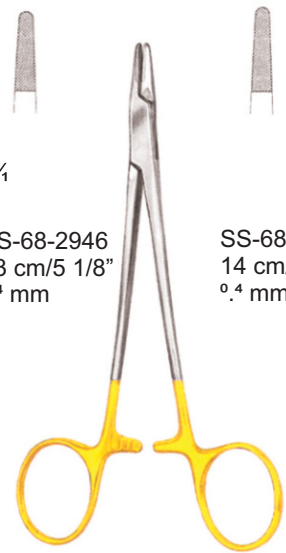
- 1/4
- SS-68-2941
16 cm/6 1/4"
0.5 mm
- SS-68-2942
18 cm/7"
0.5 mm
- SS-68-2943
20 cm/8"
0.5 mm



- 1/4
- SS-68-2944
18 cm/7"
0.4 mm
- SS-68-2945
20 cm/8"
0.4 mm

1/2
 Mayo-Hegar
 standard profile

1/2
 Debaquey
 mini profile



- 1/4
- SS-68-2946
13 cm/5 1/8"
0.4 mm
- SS-68-2947
14 cm/5 1/2"
0.4 mm

1/2
 HEGAR-BAUMGARTNER



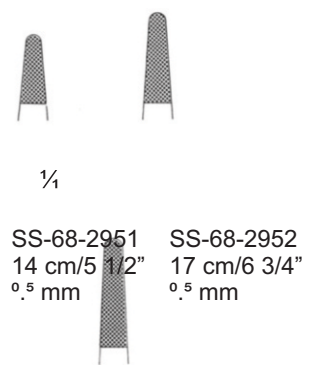
- 1/4
- SS-68-2948
14 cm/5 1/2"
0.5 mm

1/2
 Mathieu
 Standard Profile



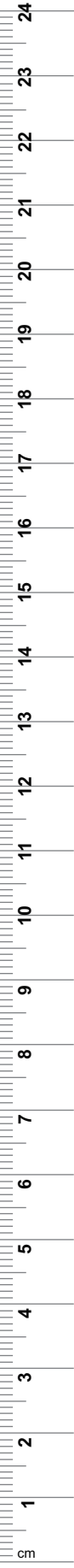
- 1/4
- SS-68-2949
17 cm/6 3/4"
0.5 mm
- SS-68-2950
20 cm/8"
0.5 mm

1/2
 Mathieu
 Standard Profile



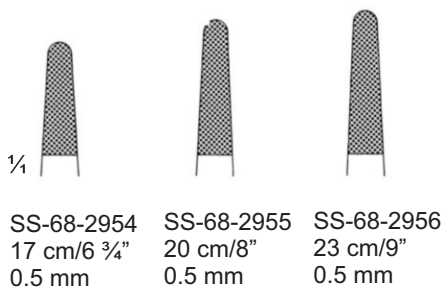
- 1/4
- SS-68-2951
14 cm/5 1/2"
0.5 mm
- SS-68-2952
17 cm/6 3/4"
0.5 mm

SS-68-2953
 20 cm/8"
 0.5 mm



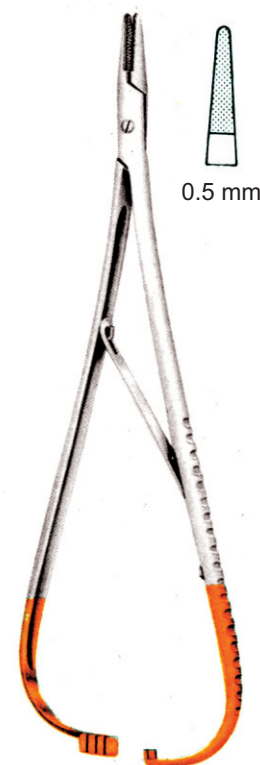


1/2
Mathieu



SS-68-2954 17 cm/6 3/4" 0.5 mm
 SS-68-2955 20 cm/8" 0.5 mm
 SS-68-2956 23 cm/9" 0.5 mm

with interior ratchet
standard profile



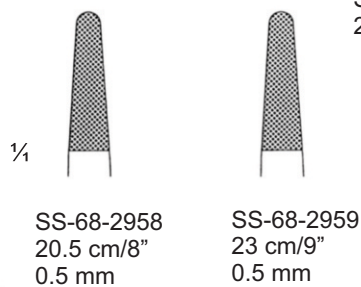
Lichtenberg
SS-68-2957
20 cm/7 7/8"



0.5 mm

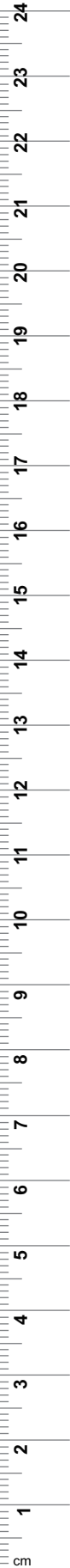
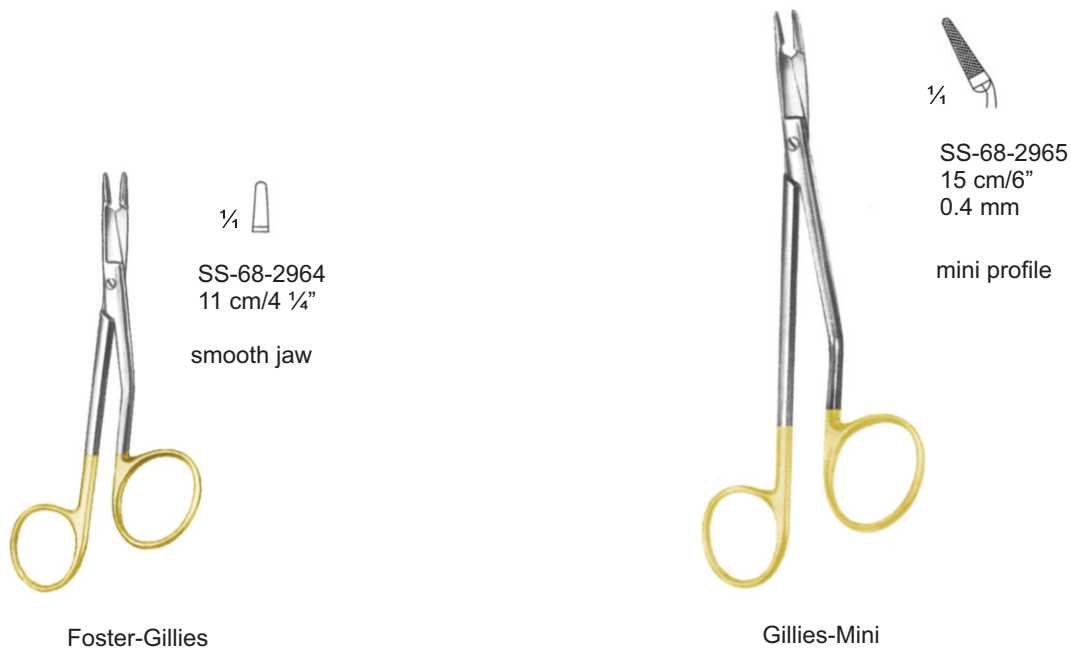
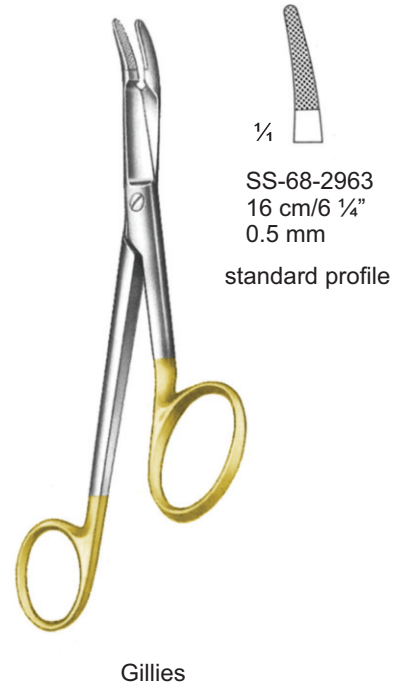
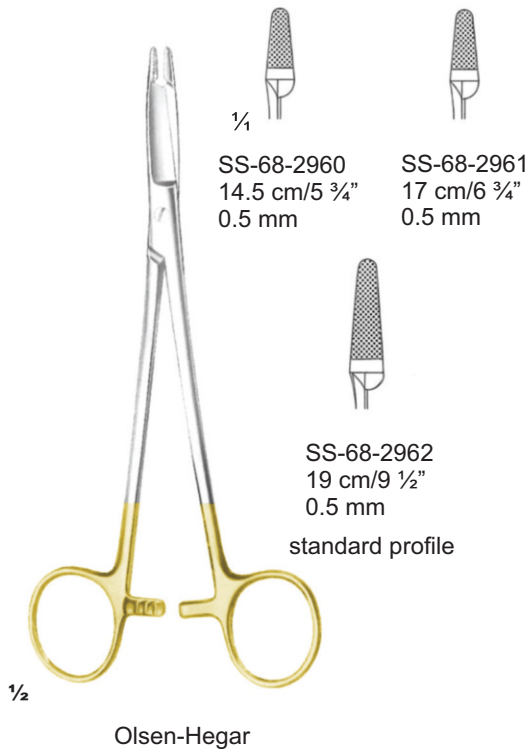


1/2
Zweifel



SS-68-2958 20.5 cm/8" 0.5 mm
 SS-68-2959 23 cm/9" 0.5 mm

with hinged rehet
Standard Profile





1/4
 SS-68-2966
 12 cm/4 3/4"
 with lock

Castroviejo



1/4
 SS-68-2967
 12 cm/4 3/4"
 with lock

Castroviejo



1/4
 SS-68-2968
 12.5 cm/5"
 with lock, smooth jaw

Castroviejo



1/4

SS-68-2969
 14.5 cm/5 3/4"
 with lock
 micro profile
 0.3 mm

SS-68-2970
 14.5 cm/5 3/4"
 with lock
 micro profile
 0.3 mm

SS-68-2971
 14.5 cm/5 3/4"
 smooth jaw
 0.3 mm

SS-68-2972
 18 cm/7"
 with lock
 micro profile
 0.3 mm

SS-68-2973
 21.5 cm/8 1/2"
 with lock
 micro profile
 0.3 mm

1/4

SS-68-2974
 14.5 cm/5 3/4"
 smooth jaw

SS-68-2975
 18 cm/7"
 with lock
 micro profile
 0.3 mm

SS-68-2976
 21.5 cm/8 1/2"
 with lock
 micro profile
 0.3 mm

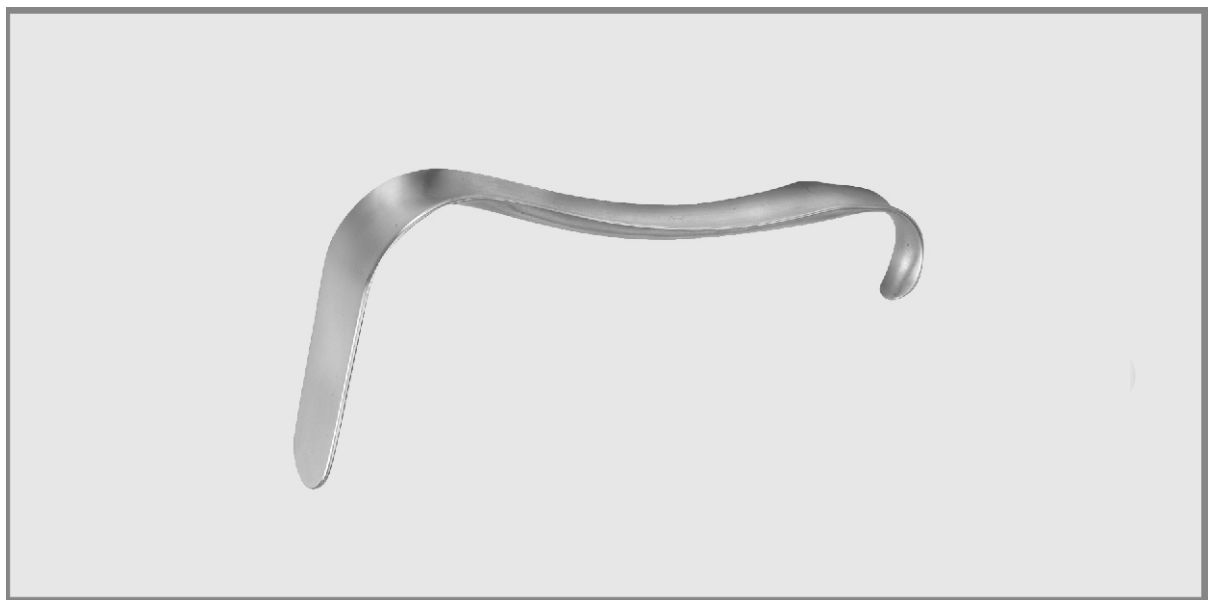
1/2

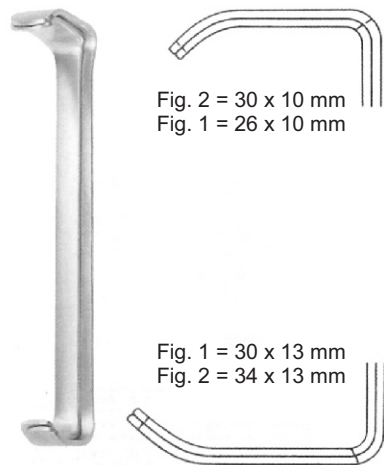
Castroviejo

69

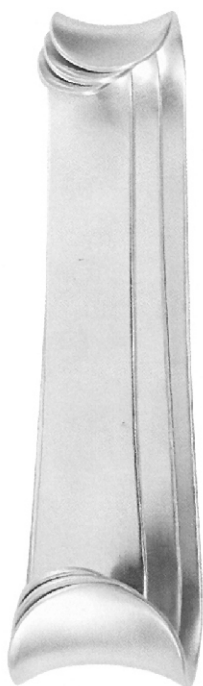
- EN** Retractors
- DE** Wundhaken
- ES** Ecarteurs

Page 144 to 148





FARABEU
 SS-69-3001
 12 cm/4 3/4"
 Fig. 1 - 2



ROUX
 SS-69-3002
 Set complete, Fig. 1- 3

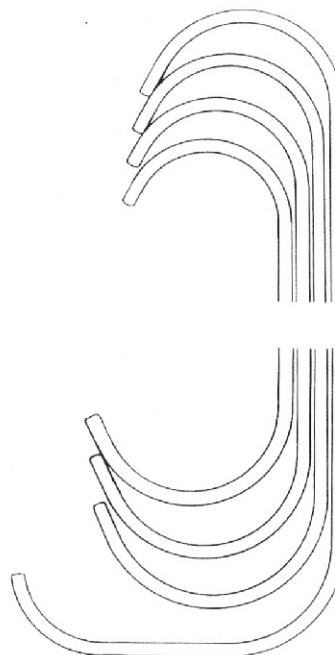
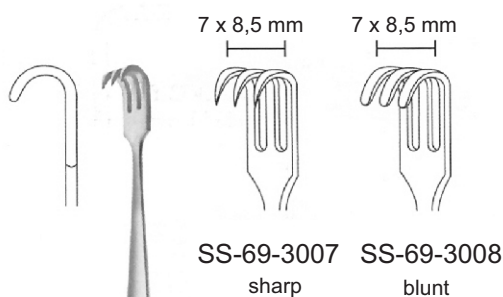


Fig. 1	14 cm/5 1/2"	SS-69-3003	24 x 20 / 30 x 28
Fig. 2	15 cm/6"	SS-69-3004	29 x 26 / 36 x 36
Fig. 3	17 cm/6 3/4"	SS-69-3005	23 x 29 / 38 x 43
Fig. 4	18 cm/7"	SS-69-3006	29 x 24 / 45 x 28



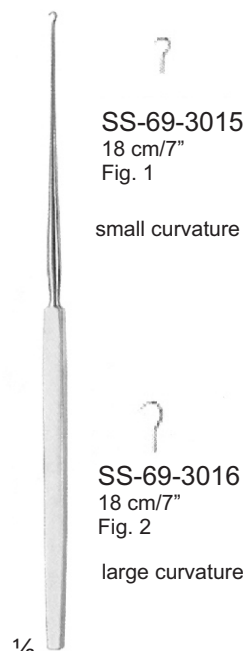
1/2
 SENN
 17 cm/6 3/4"



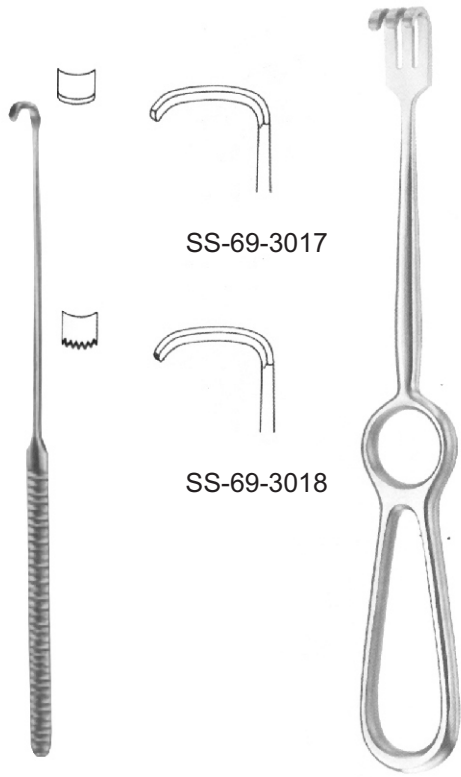
1/2
 16 cm/6 1/4" SS-69-3011



1/2
 16 cm/6 1/4" SS-69-3014

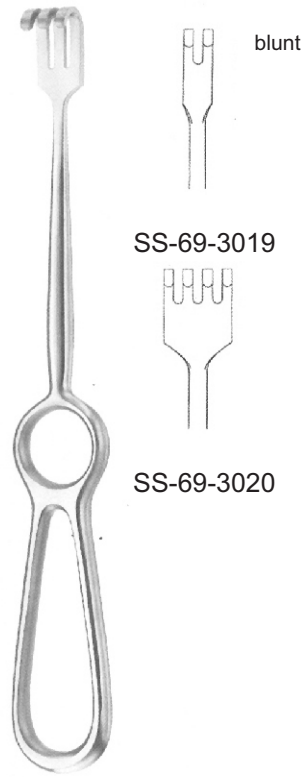


1/2
 GILLIES
 18 cm/7"



SS-69-3017

SS-69-3018



blunt

SS-69-3019

SS-69-3020

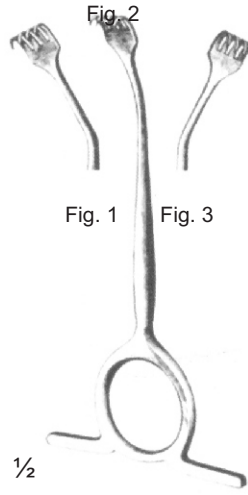


Fig. 2

Fig. 1

Fig. 3

1/2

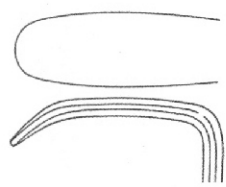
WILLIGER

STRANDELL-STILLE
 19, cm/7 1/2"

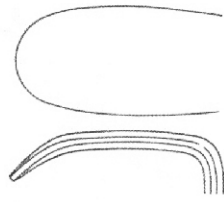
VOLKMANN
 21,5 cm/8 1/2"



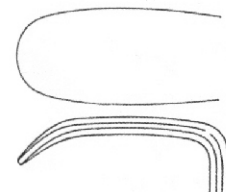
LANGENBECK
 22 cm/8 3/4"



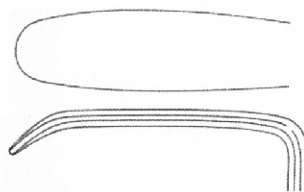
SS-69-3027
 30x 11 mm



SS-69-3029
 30x 16 mm



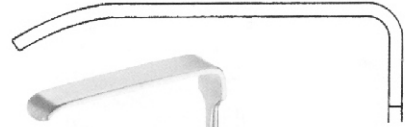
SS-69-3028
 30x 14 mm



SS-69-3030
 40x 11 mm



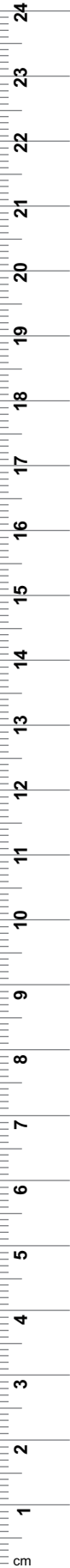
SS-69-3031
 40x 11 mm



SS-69-3032
 55x 11 mm

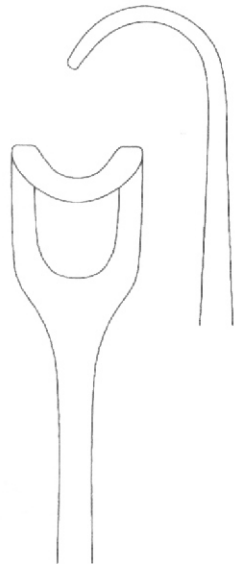


KOCHER-LANGENBECK
 22 cm/8 1/2"

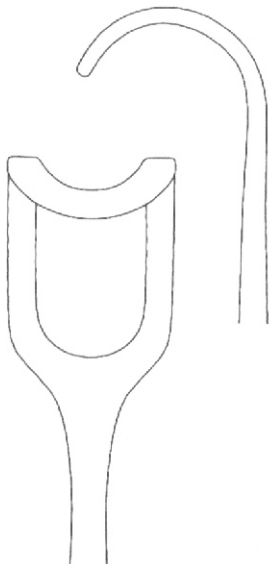




MIDDELDORPF



SS-69-3033
 21,5 cm/8 1/2"
 14 x 17 mm



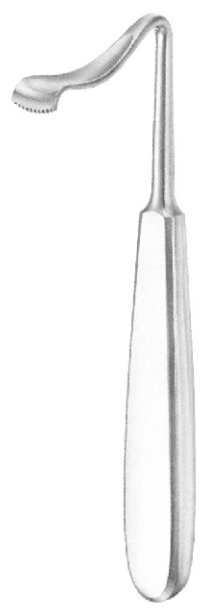
SS-69-3034
 22 cm/8 3/4"
 20 x 22 mm



KOCHER LANGENBECK
 SS-69-3035
 21 cm/8 1/4"
 23 x 8 mm



WARD
 SS-69-3036
 15,5 cm/6"



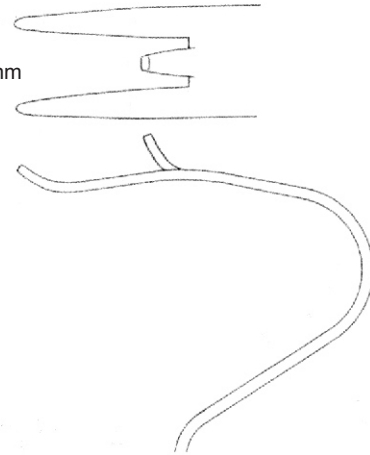
BOWDLER=HENRY
 SS-69-3037
 16 cm/6 1/4"



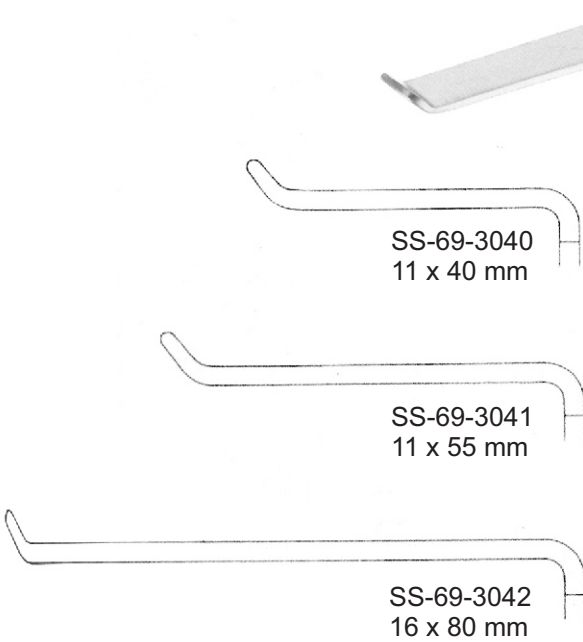
KAY (AUSTIN)
 SS-69-3038



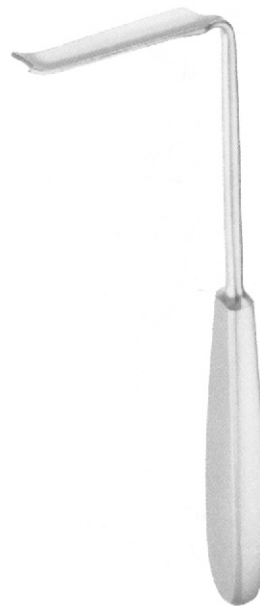
16,5 mm



OBWEGESER
 SS-69-3039
 16 cm/6 1/4"



OBWEGESER
 21,5 cm/8 1/2"

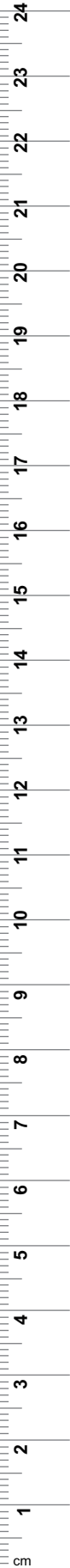


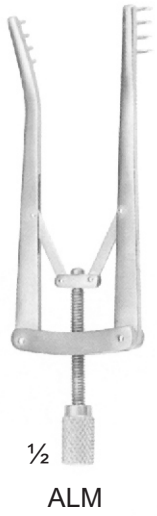
SS-69-3043
 30 x 9/12 mm

SS-69-3044
 45 x 9/12 mm

SS-69-3045
 60 x 9/12 mm

OBWEGESER

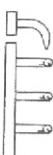




SS-69-3046
 7 cm/2 3/4"
 sharp



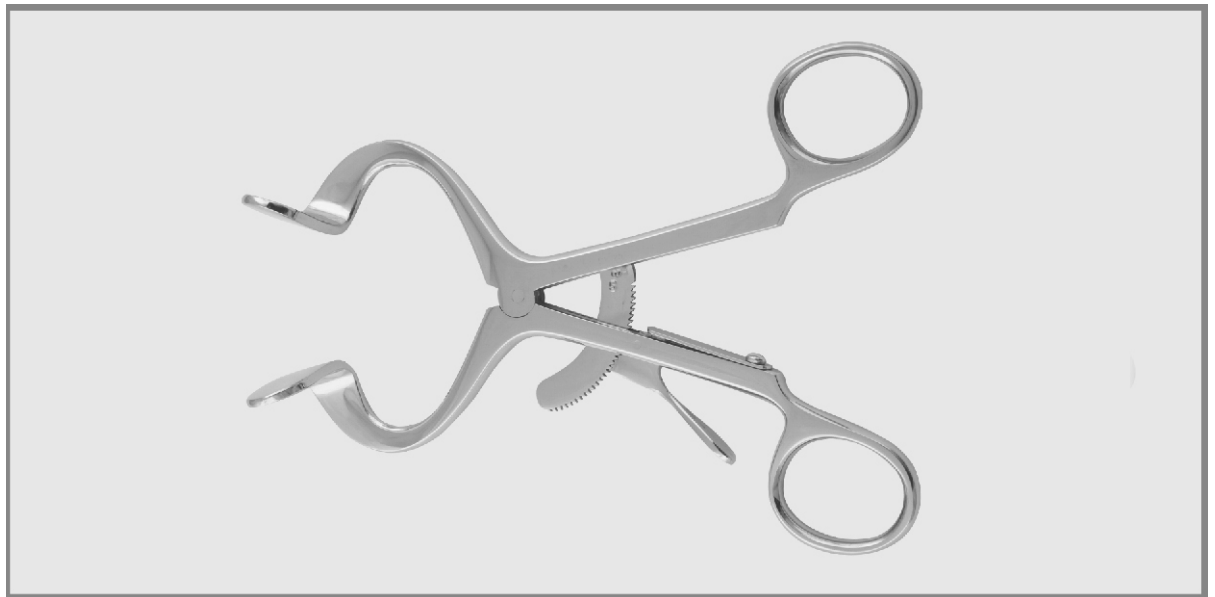
SS-69-3047
 10 cm/4"
 sharp



70

- EN** Mouth and Tongue
- DE** Mund und Zunge
- ES** Boca y la lengua

Page 149 to 152





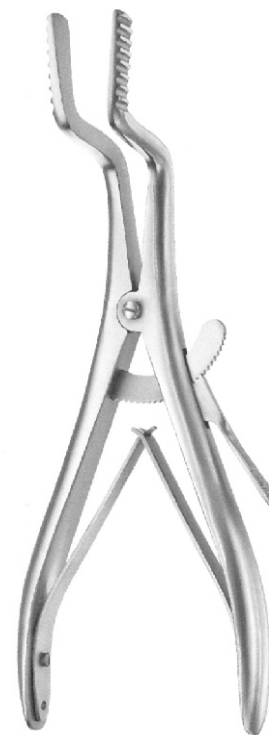
DOYEN-JANSEN (MOLT)
 SS-70-3100 9 cm/3 1/2"
 SS-70-3101 11 cm/4 1/2"
 SS-70-3102 14 cm/5 1/2"



DENHARDT
 SS-70-3103
 12 cm/5"



HEISTER
 SS-70-3104
 13 cm/5 1/4"



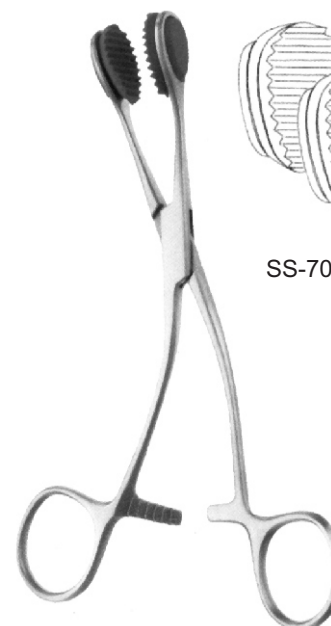
ROSER-KOENIG
 16 cm/6 1/4" SS-70-3105
 19 cm/7 1/2" SS-70-3106



JENNINGS
 9 cm/3 1/2" SS-70-3107
 11 cm/4 1/2" SS-70-3108
 13 cm/5" SS-70-3109
 15 cm/6" SS-70-3110



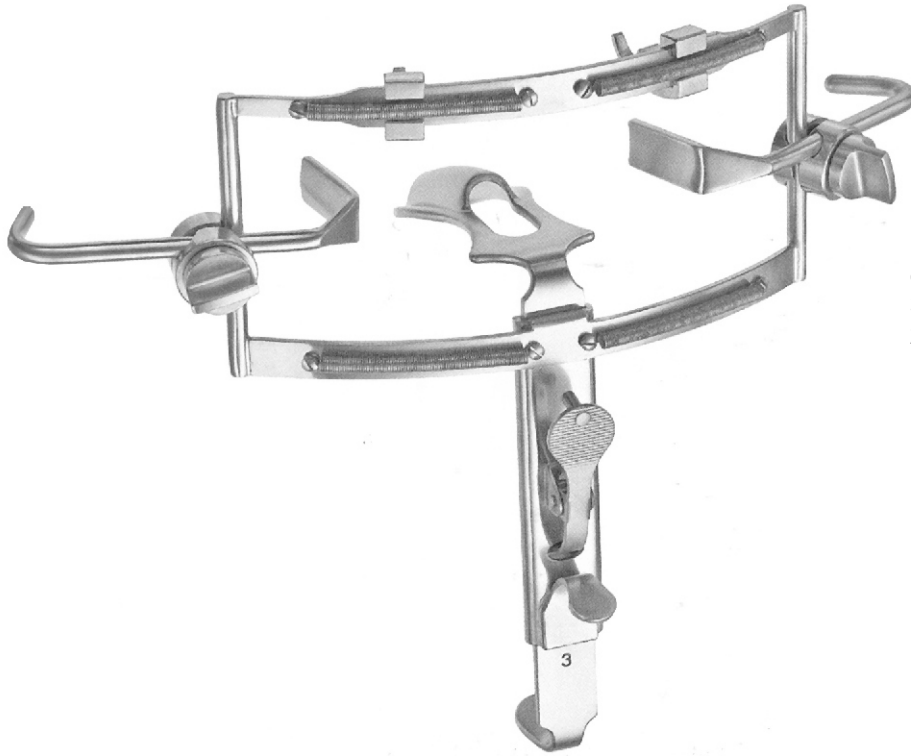
COLLIN
 SS-70-3111
 16 cm/6 1/2"



YOUNG
 SS-70-3112
 16 cm/6 1/2"

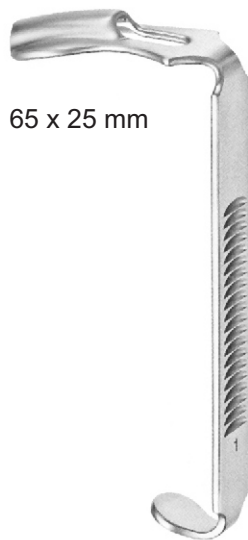


SS-70-3113



complete with frame,
 3 tongue depressors,
 2 tooth plates

DINGMANN
 SS-70-3114
 14,5 cm/5 3/4"



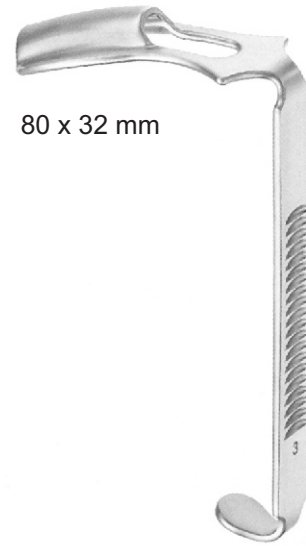
65 x 25 mm

SS-70-3115
 13,5 cm/5 1/4"



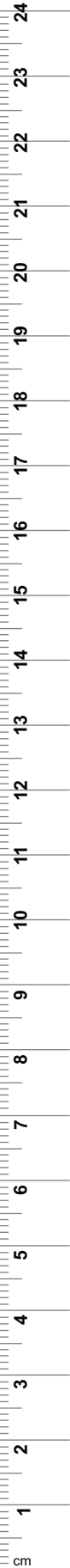
70 x 29 mm

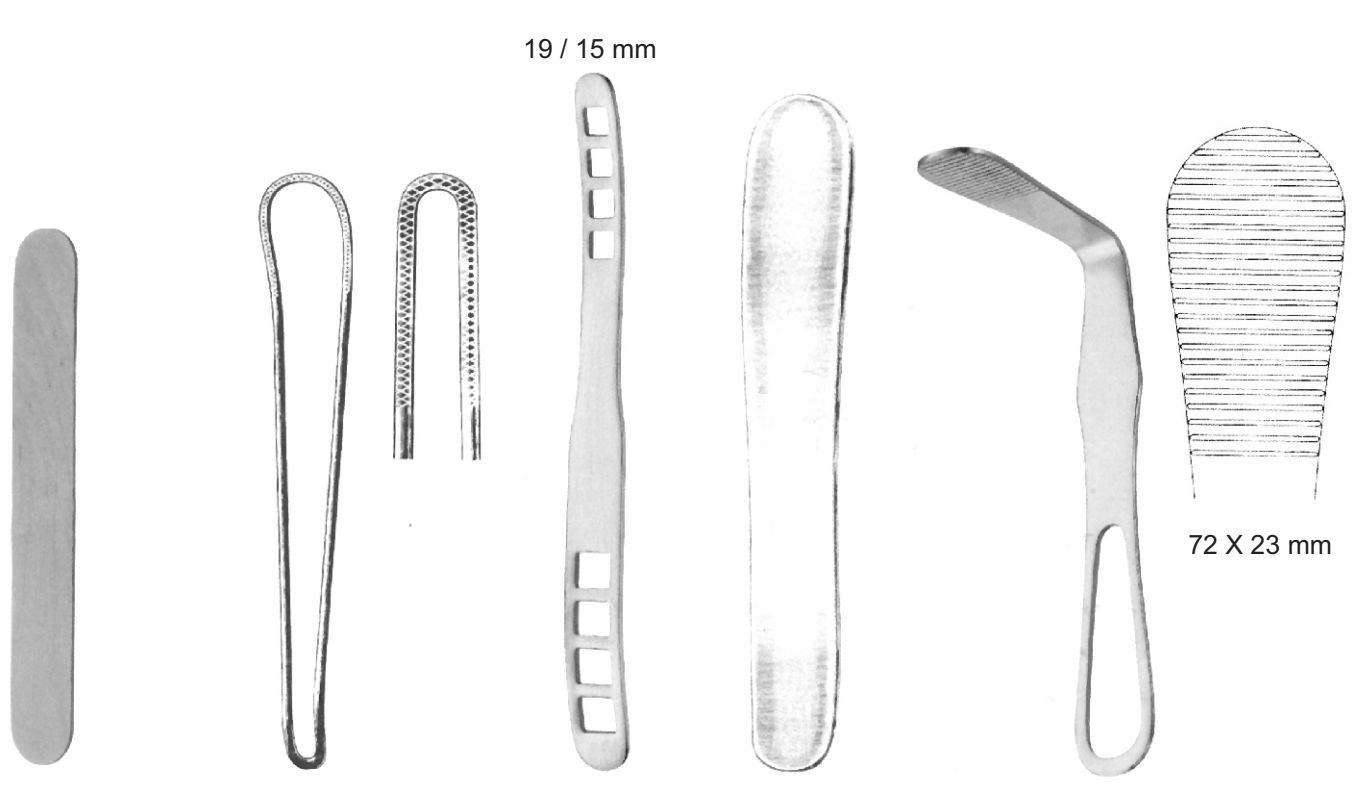
SS-70-3116
 13,5 cm/5 1/4"



80 x 32 mm

SS-70-3117
 13,5 cm/5 1/4"





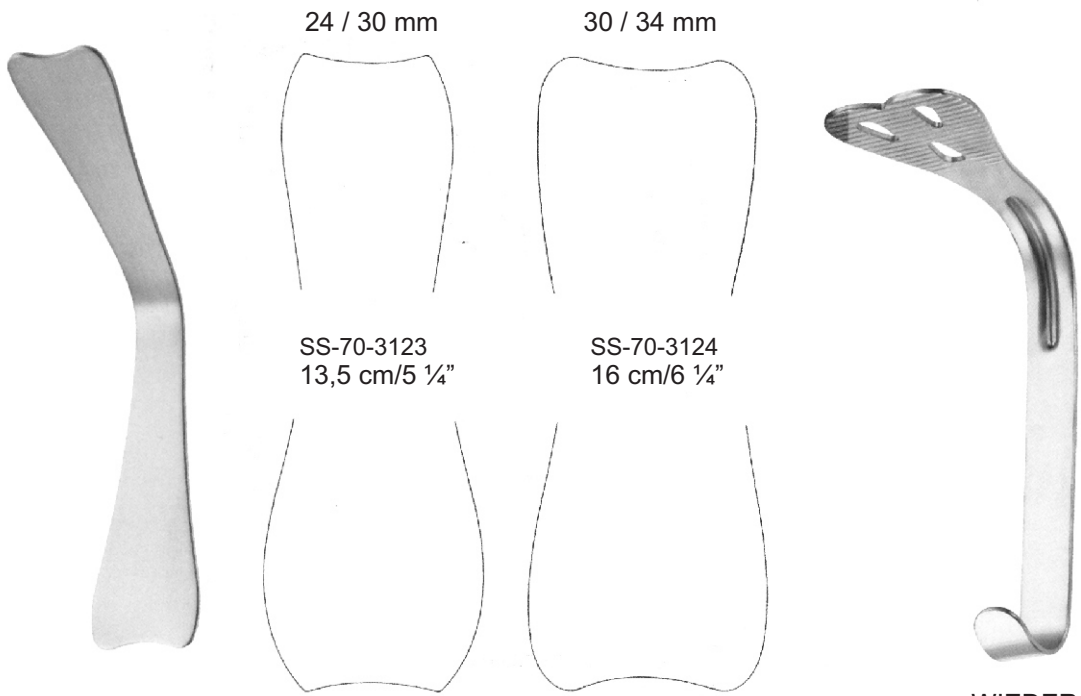
SS-70-3118
16 cm/6 1/4"

FRENZEL
SS-70-3119
16,5 cm/6 1/2"

BRUENINGS
SS-70-3120
19 cm/7 1/2"

BUCHWALD
SS-70-3121
19 cm/7 1/2"

HARTMANN
SS-70-3122
15 cm/6"



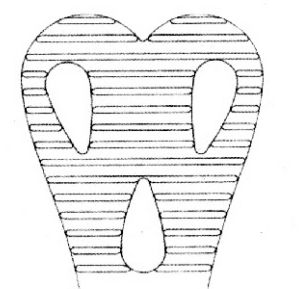
24 / 30 mm

30 / 34 mm

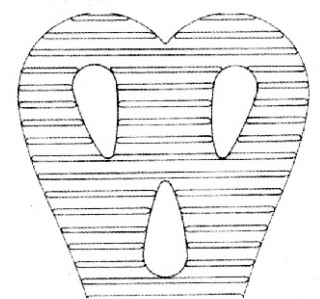
SS-70-3123
13,5 cm/5 1/4"

SS-70-3124
16 cm/6 1/4"

WIEDER



SS-70-3125
14 cm/5 1/2"
36 mm

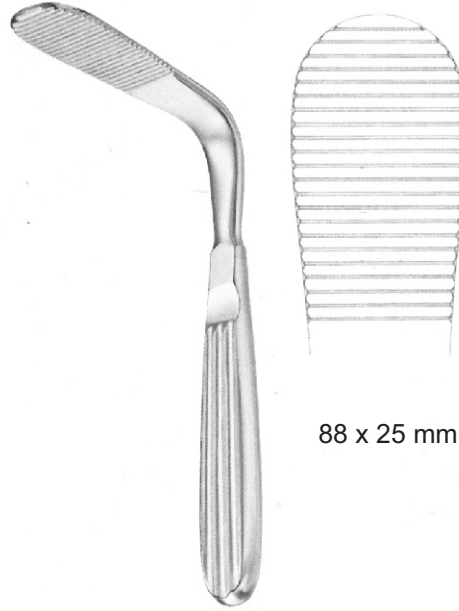


SS-70-3126
15 cm/6"
43 mm



85 x 24 mm

TOBOLD
 SS-70-3127
 14,5 cm/5 ¾"



88 x 25 mm

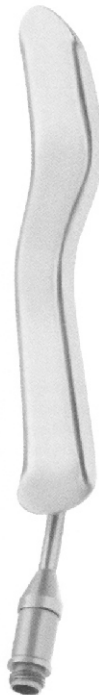
TOBOLD
 SS-70-3128
 15 cm/6"



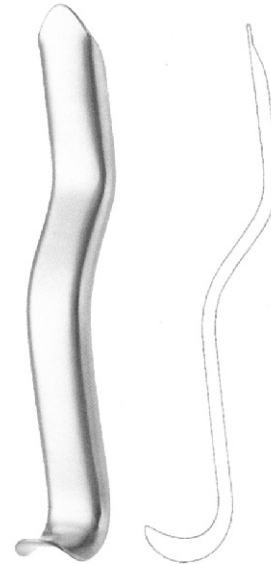
STERNBERG
 SS-70-3129
 14 cm/5 ½"



SIMPLEX
 SS-70-3130
 11 cm/4 ¼"



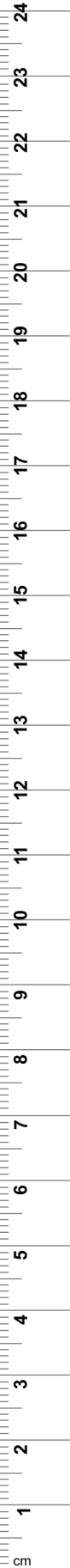
CAWOOD-MINNESOTA
 SS-70-3131
 14 cm/5 ½"



CAWOOD-MINNESOTA
 SS-70-3132
 15 cm/6"
 20 mm



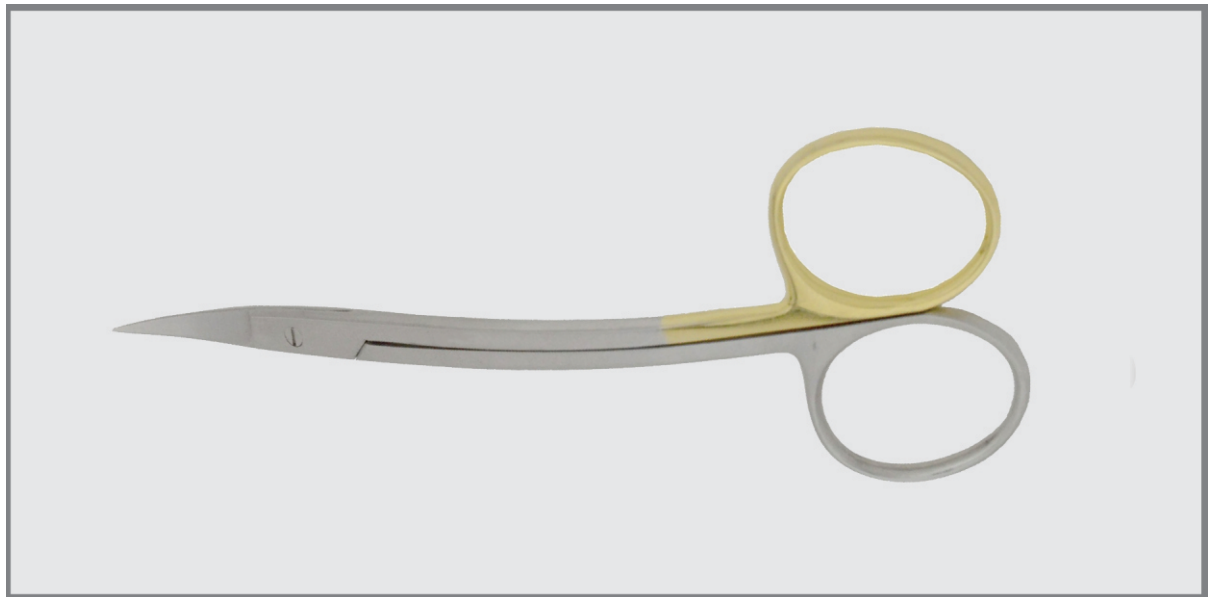
SS-70-3133
 19 cm/7 ½"



71

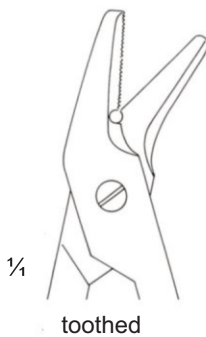
- EN** Scissors
- DE** Schere
- ES** Tijeras

Page 153 to 171

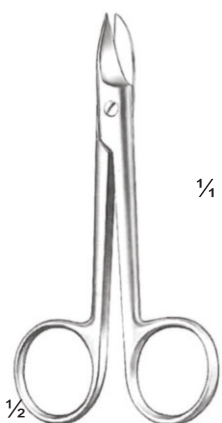




SS-71-3200
 universal
 12 cm/4 3/4"



SS-71-3201 TC
 universal
 12 cm/4 3/4"



Beebee
 10.5 cm/4 1/8"



SS-71-3202
 B-002-10 TC



SS-71-3203
 B-003-10 TC



SS-71-3204
 B-004-10 TC



SS-71-3205
 B-005-10 TC

one toothed cutting edge

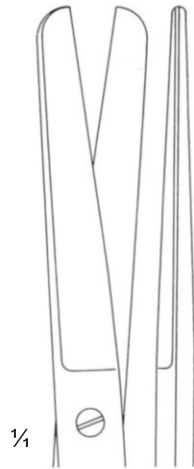


Beebee
 10.5 cm/4 1/8"





1/2
 Standard
 14.5 cm/5 3/4



1/4
 SS-71-3206
 SS-71-3207 TC



1/4
 SS-71-3208
 SS-71-3209 TC



1/4
 SS-71-3210
 SS-71-3211 TC



1/2
 Standard
 14.5 cm/5 3/4



1/2
 Standard
 14.5 cm/5 3/4



1/4
 SS-71-3212
 SS-71-3213 TC



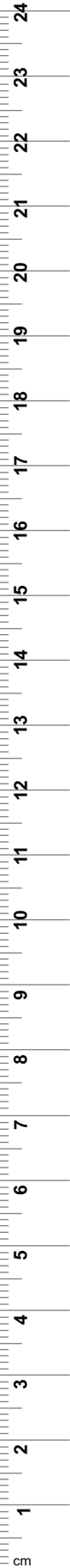
1/4
 SS-71-3214
 SS-71-3215 TC



1/4
 SS-71-3216
 SS-71-3217 TC



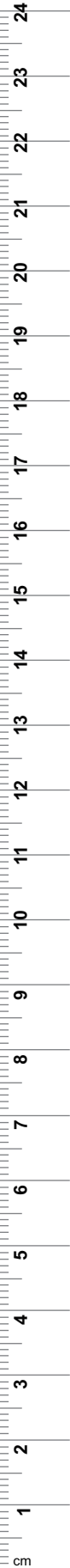
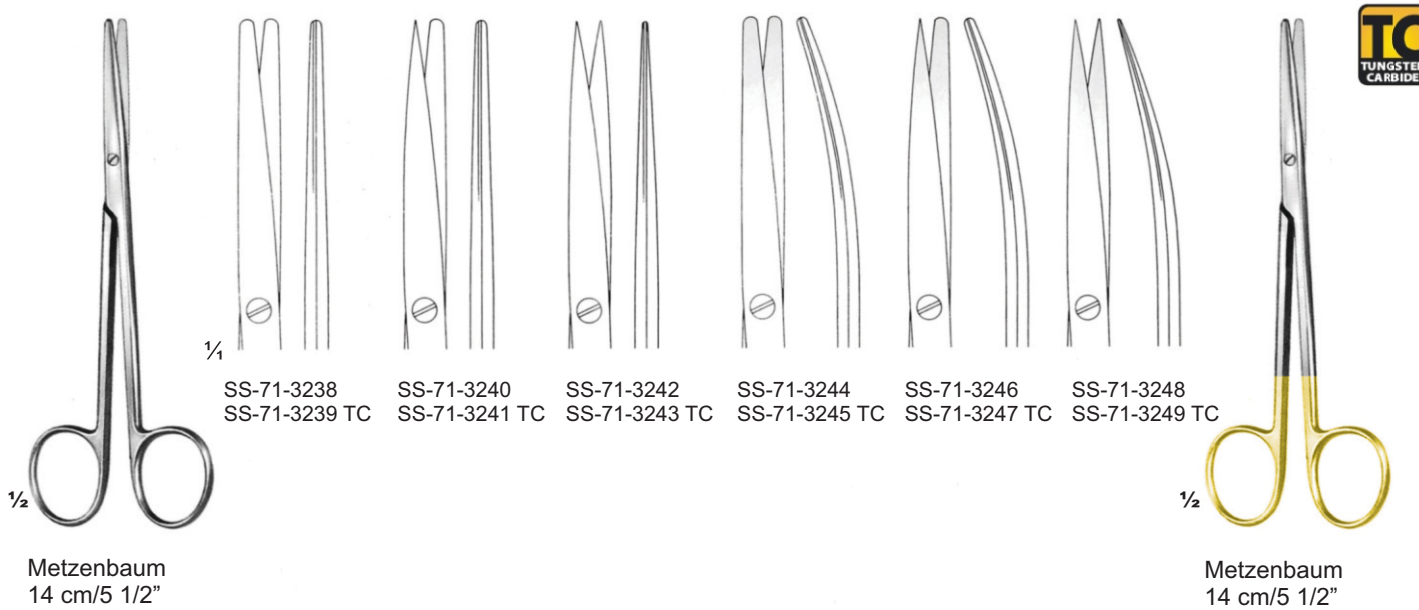
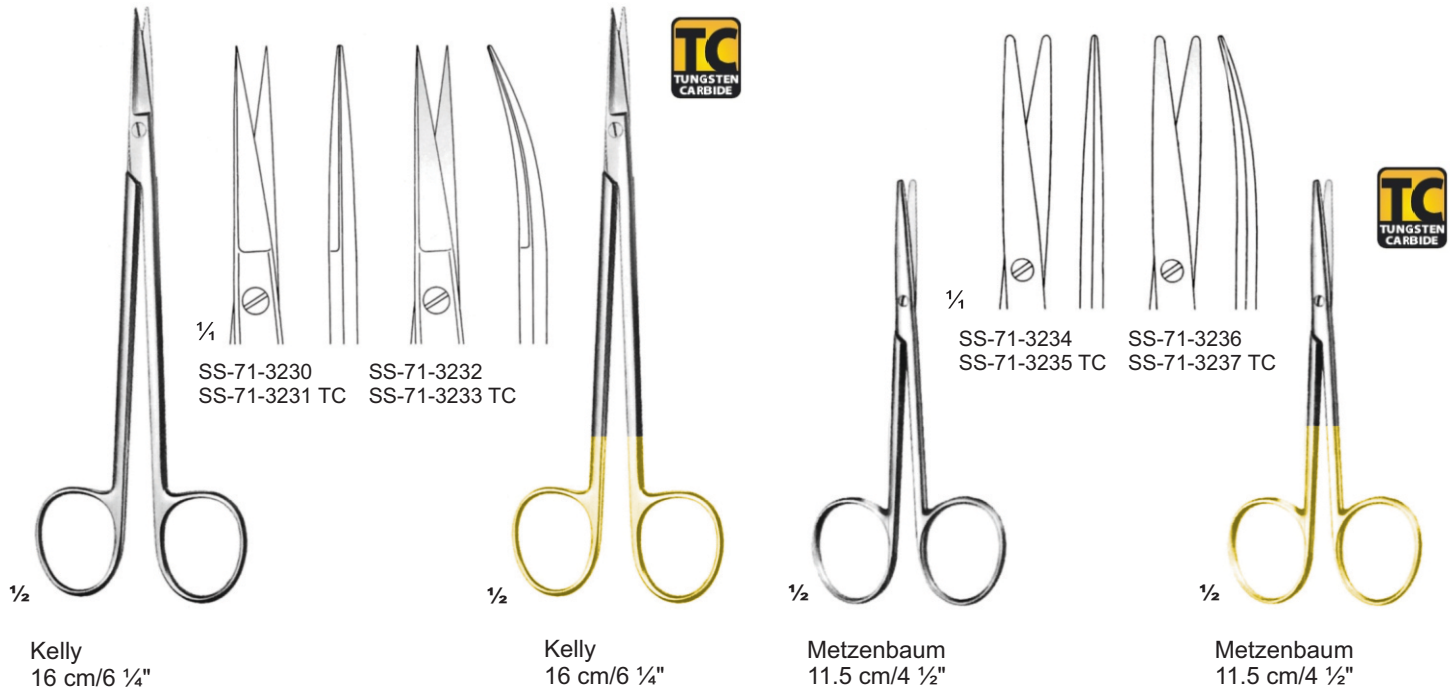
1/2
 Standard
 14.5 cm/5 3/4





DELICATE

 $\frac{1}{2}$ 14.5 cm/5 $\frac{3}{4}$ "	 $\frac{1}{4}$ SS-71-3218 SS-71-3219 TC	 $\frac{1}{4}$ SS-71-3220 SS-71-3221 TC	 $\frac{1}{4}$ SS-71-3222 SS-71-3223 TC	 $\frac{1}{2}$ 14.5 cm/5 $\frac{3}{4}$ "
 $\frac{1}{2}$ 14.5 cm/5 $\frac{3}{4}$ "	 $\frac{1}{4}$ SS-71-3224 SS-71-3225 TC	 $\frac{1}{4}$ SS-71-3226 SS-71-3227 TC	 $\frac{1}{4}$ SS-71-3228 SS-71-3229 TC	 $\frac{1}{2}$ 14.5 cm/5 $\frac{3}{4}$ "

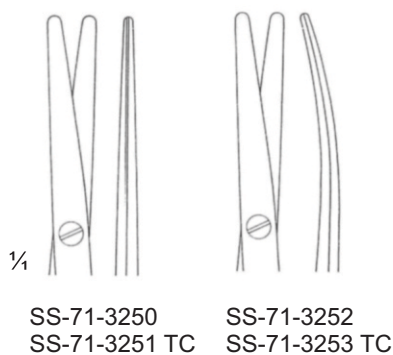




DELICATE



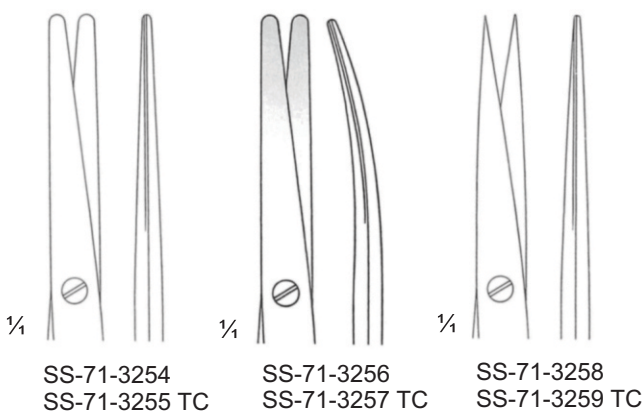
Metzenbaum
15.5 cm/6"



Metzenbaum
15.5 cm/6"

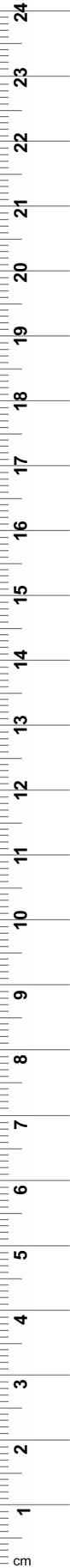
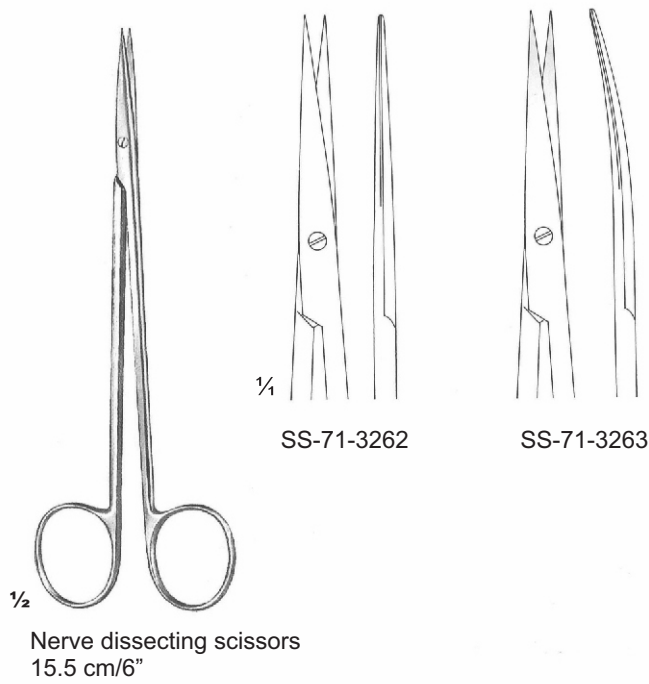
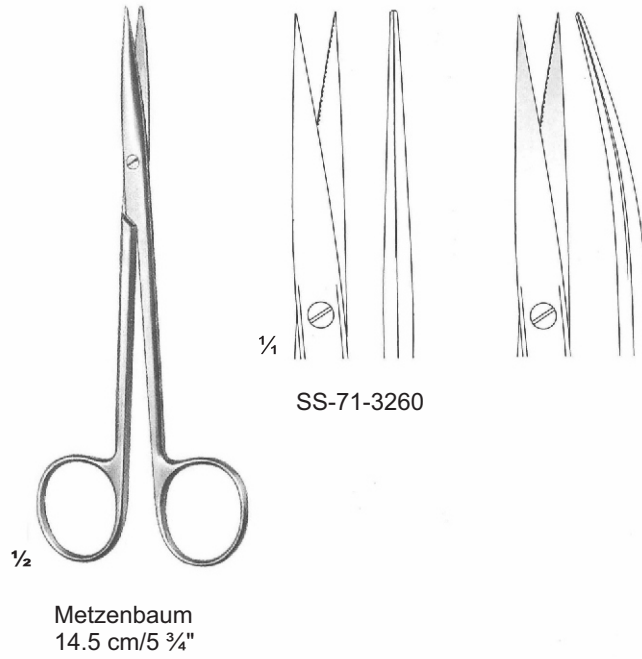


Metzenbaum-Nelson
18 cm/7"



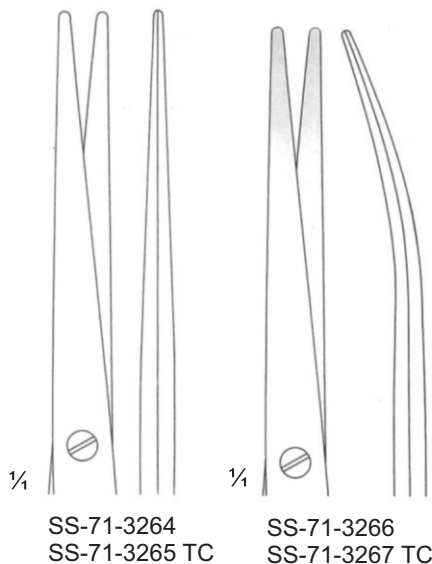
Metzenbaum-Nelson
18 cm/7"



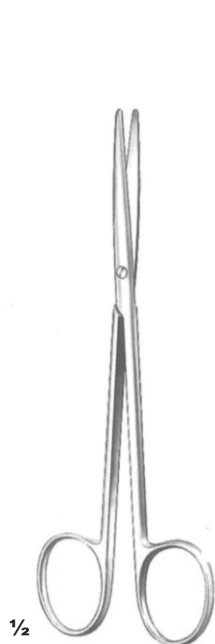




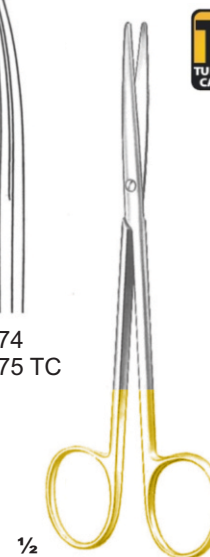
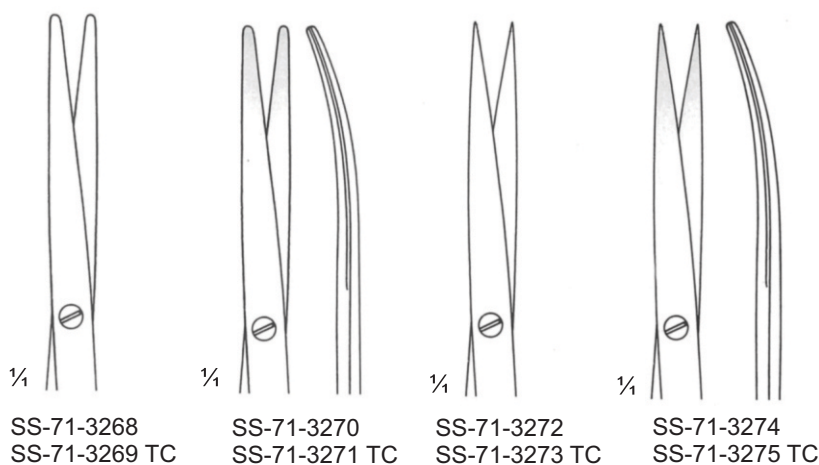
Lexer-Fino
slender pattern
16.5 cm/6 1/2"



Lexer-Fino
slender pattern
16.5 cm/6 1/2"



Metzenbaum-Fino
slender pattern
14.5 cm/5 3/4"



Metzenbaum-Fino
slender pattern
14.5 cm/5 3/4"



Metzenbaum-Fino
slender pattern
18 cm/7"



SS-71-3276
SS-71-3277 TC



SS-71-3278
SS-71-3279 TC



Metzenbaum-Fino
slender pattern
18 cm/7"



Metzenbaum-Fino
S shaped
18 cm/7"



SS-71-3280
SS-71-3281 TC



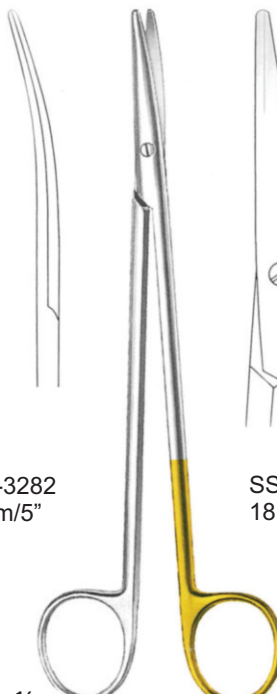
Metzenbaum-Fino
S shaped
18 cm/7"



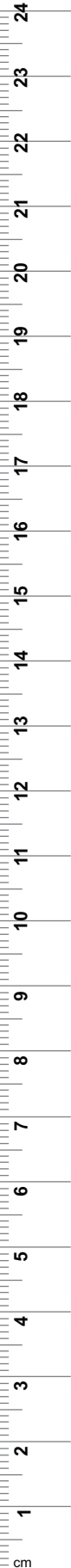
SS-71-3282
12.5 cm/5"



SS-71-3283
18 cm/7"



Salzer
fine model for cleft palate





Gum scissors, operating scissors — EN
 Zahnfleischscheren, chirurgische scheren — DE
 Tijeras para encías, Tijeras quirúrgicas — ES



SS-71-3295
 SS-71-3296 TC
 SS-71-3297
 SS-71-3298 TC

GOLDMANN-FOX
 13 cm/5 1/8"



SS-71-3299
 SS-71-3300 TC

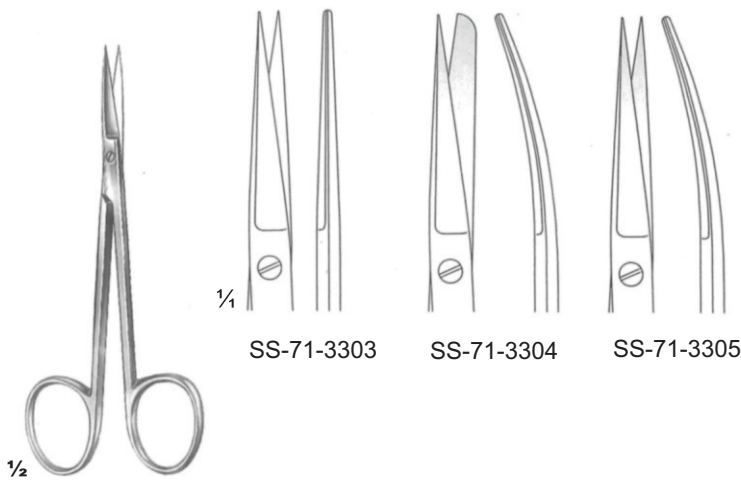
GOLDMANN-FOX
 13 cm/5 1/8"



SS-71-3301
 SS-71-3302 TC
 SS-71-3303

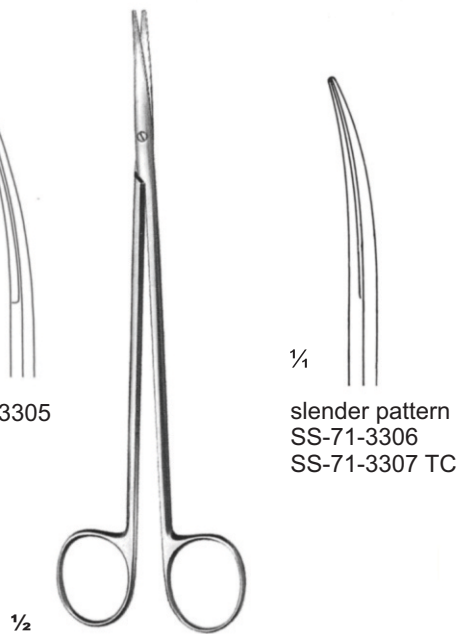
Toothed Blades

GOLDMANN-FOX
 13 cm/5 1/8"



1/4
 SS-71-3303
 SS-71-3304
 SS-71-3305

1/2
Small modle
 12 cm/4 3/4"

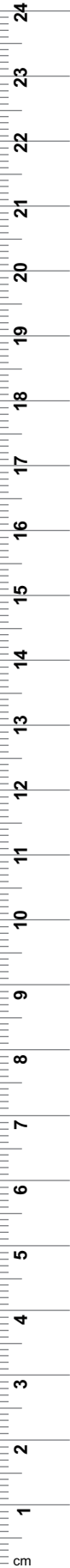


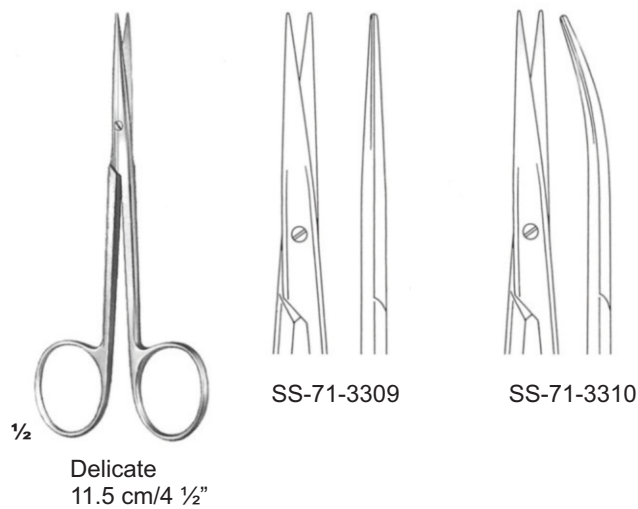
1/4
 slender pattern
 SS-71-3306
 SS-71-3307 TC

1/2
Toennis-Adson
 17.5 cm/7"



1/2
Toennis-Adson
 17.5 cm/7"





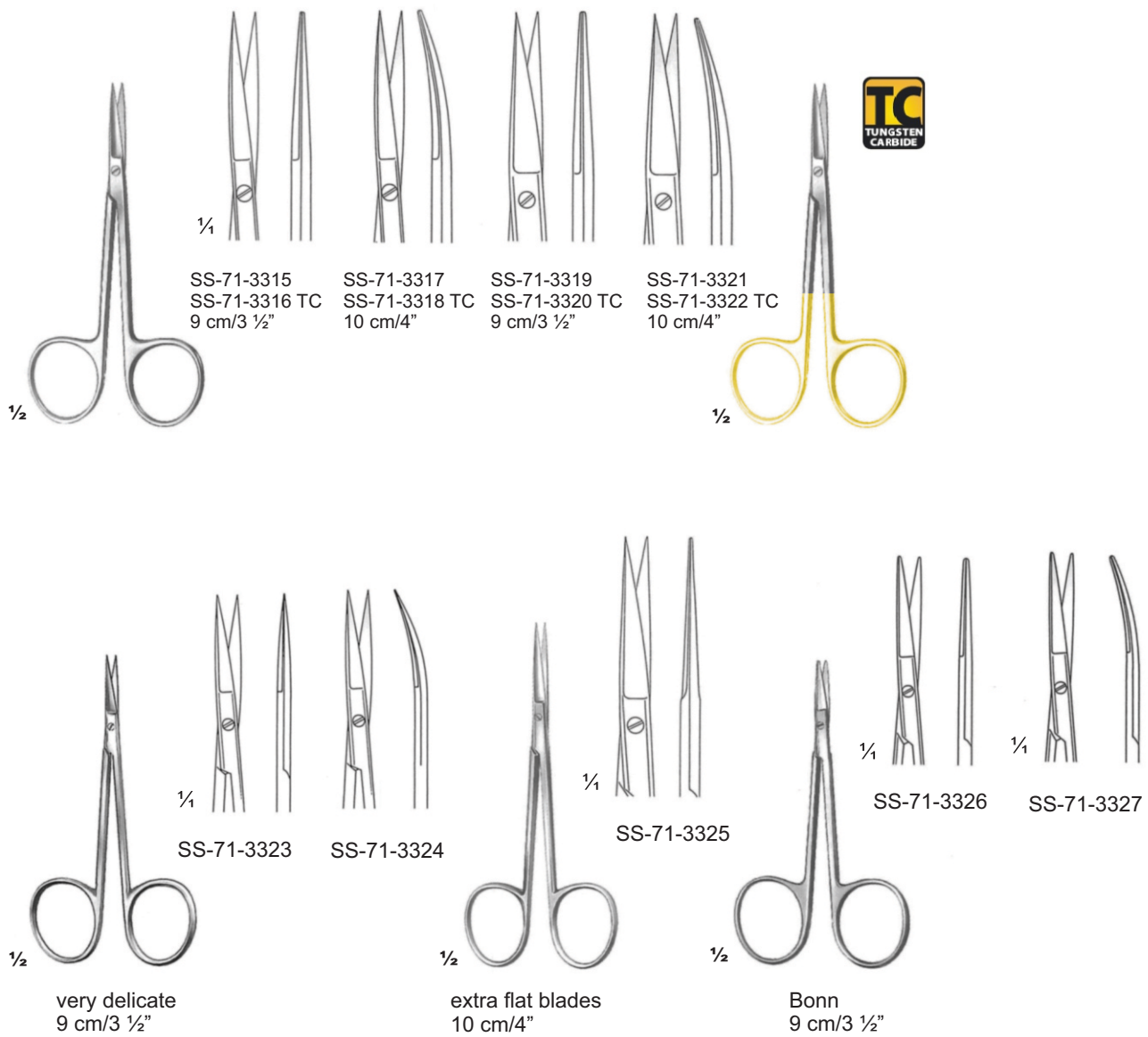
one toothed cutting edge

one toothed cutting edge

Iris scissors ● EN

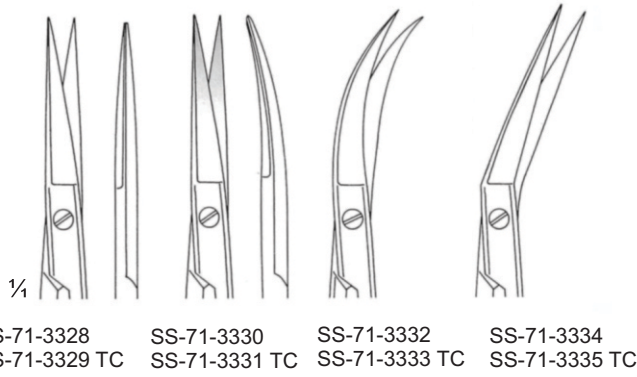
Irisscheren ● DE

Tijeras para iridectomía ● ES

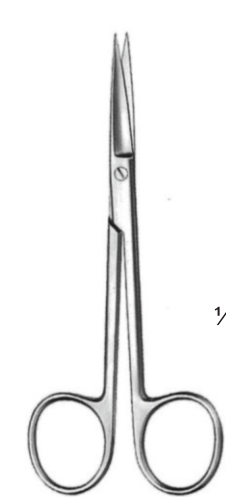




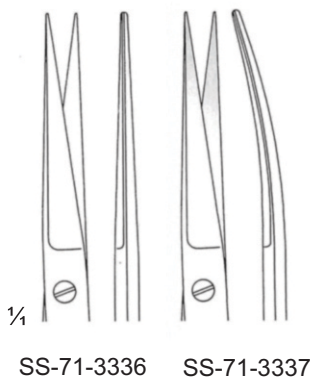
11.5 cm/4 1/2"



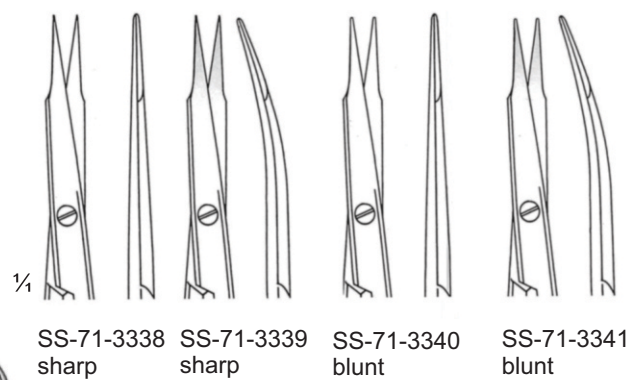
11.5 cm/4 1/2"



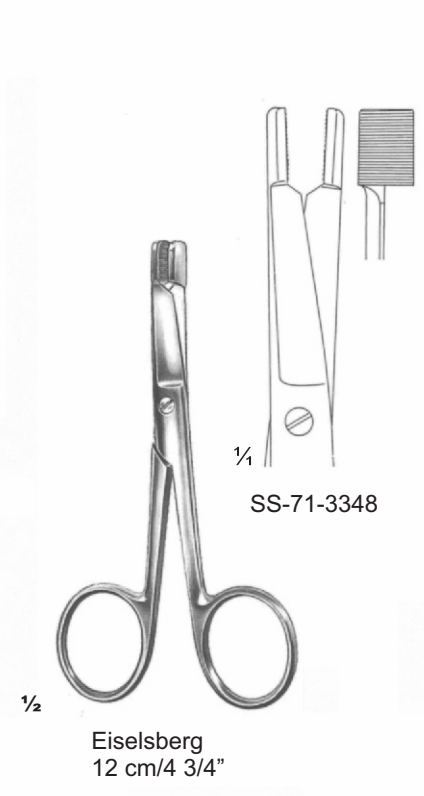
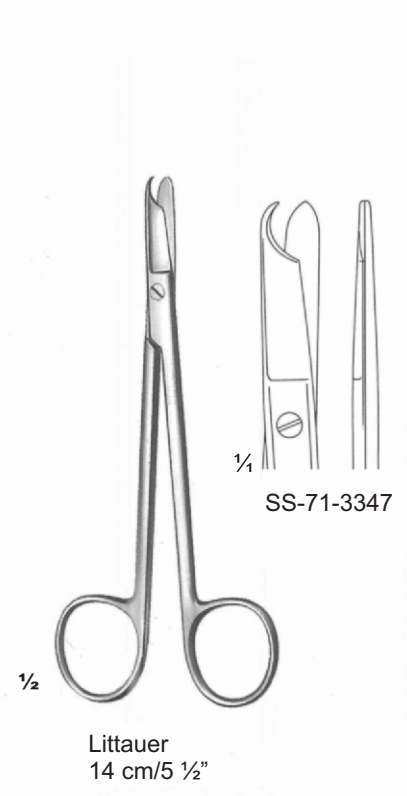
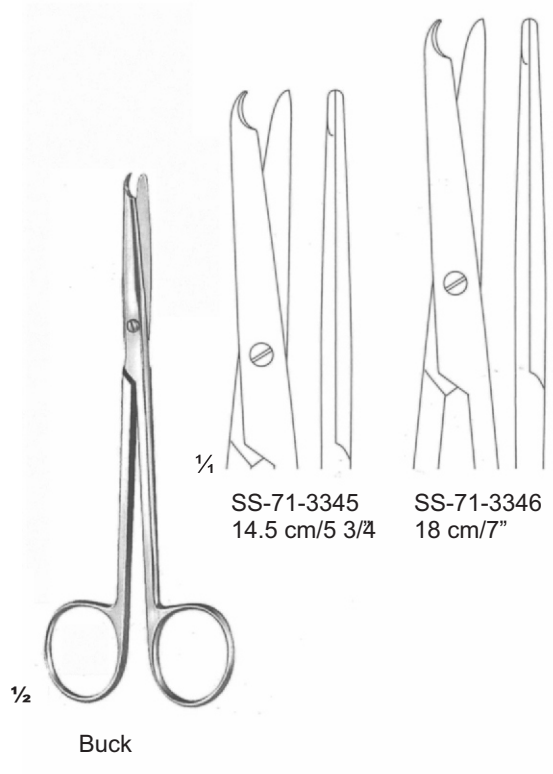
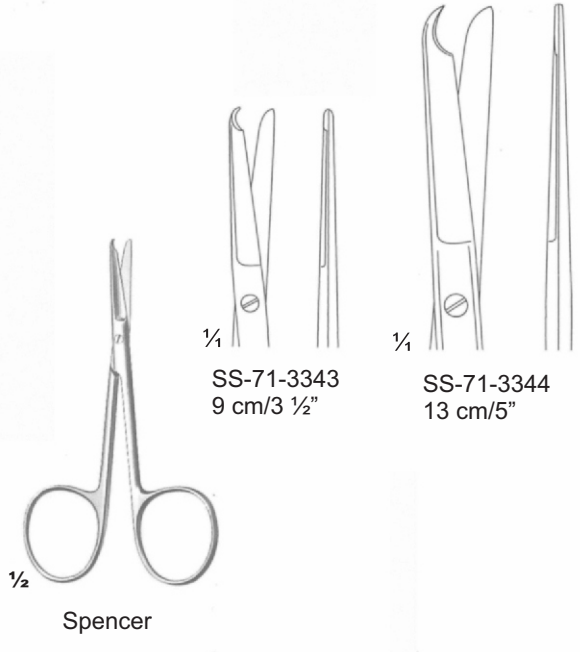
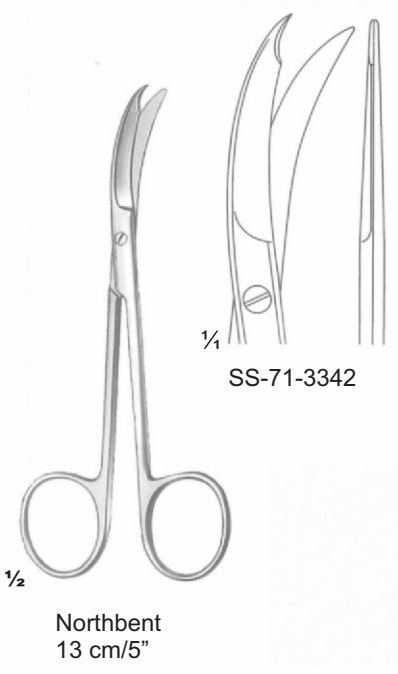
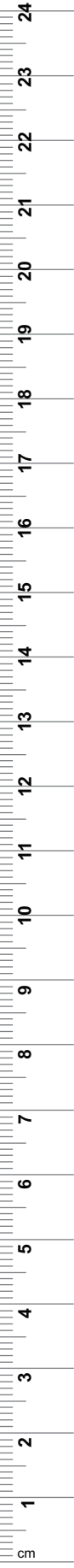
12.5 cm/5"

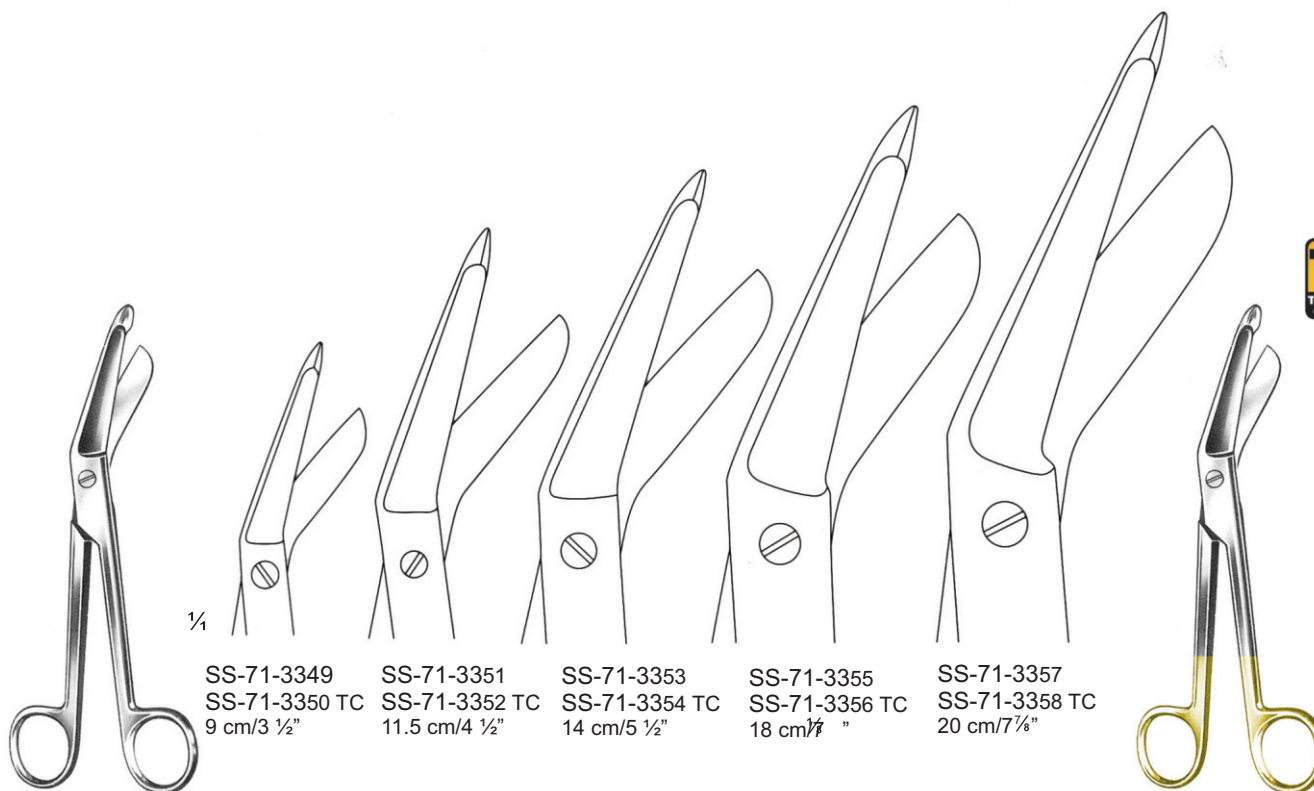


Stevens
11 cm/4 1/2"



Stitch scissors ● EN
 Fadenscheren ● DE
 Tijeras para hilos ● ES



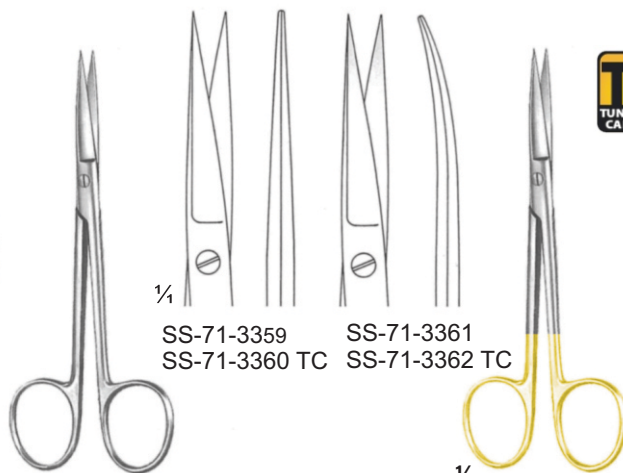


1/4

SS-71-3349 SS-71-3351 SS-71-3353 SS-71-3355 SS-71-3357
 SS-71-3350 TC SS-71-3352 TC SS-71-3354 TC SS-71-3356 TC SS-71-3358 TC
 9 cm/3 1/2" 11.5 cm/4 1/2" 14 cm/5 1/2" 18 cm/7" 20 cm/7 7/8"

LISTER

LISTER



1/4

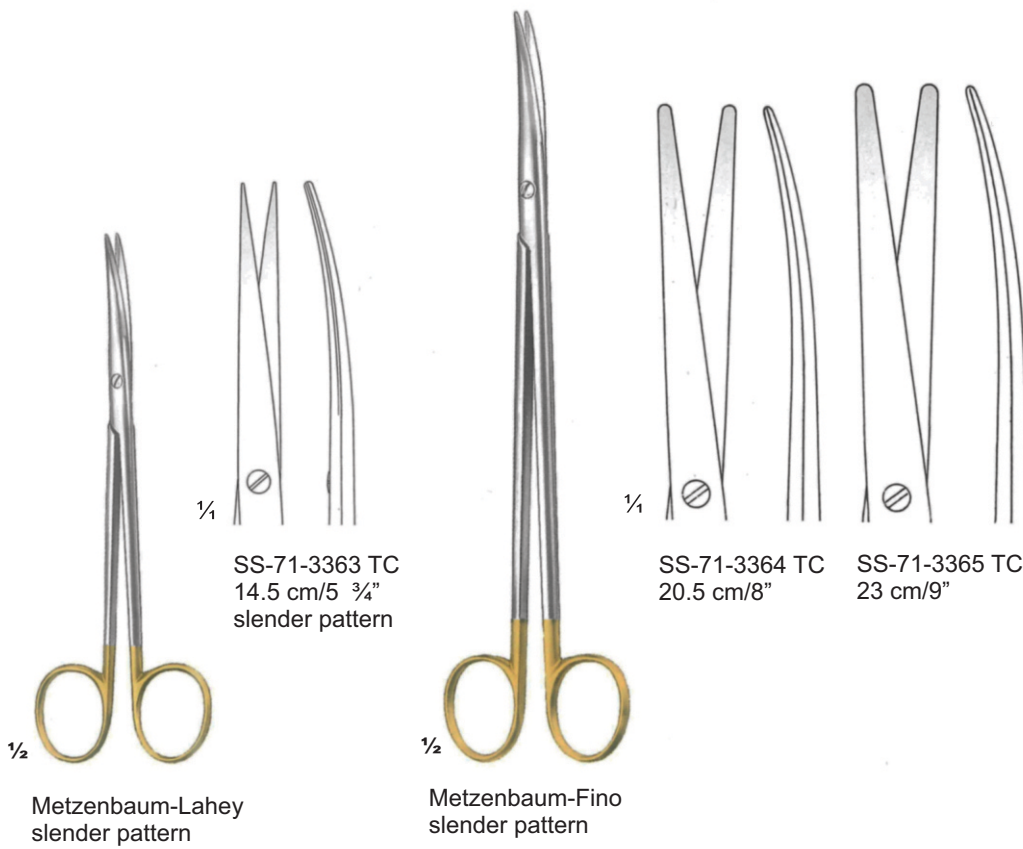
SS-71-3359 SS-71-3361
 SS-71-3360 TC SS-71-3362 TC

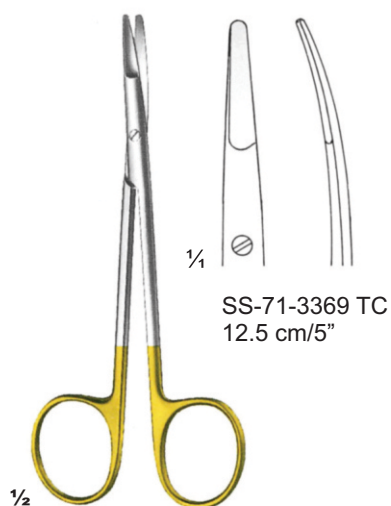
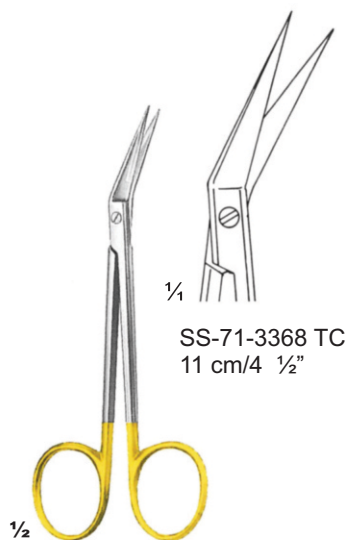
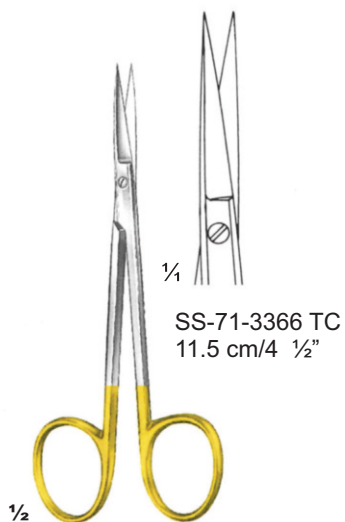
1/2

1/2

Wagner
12 cm/4 3/4"

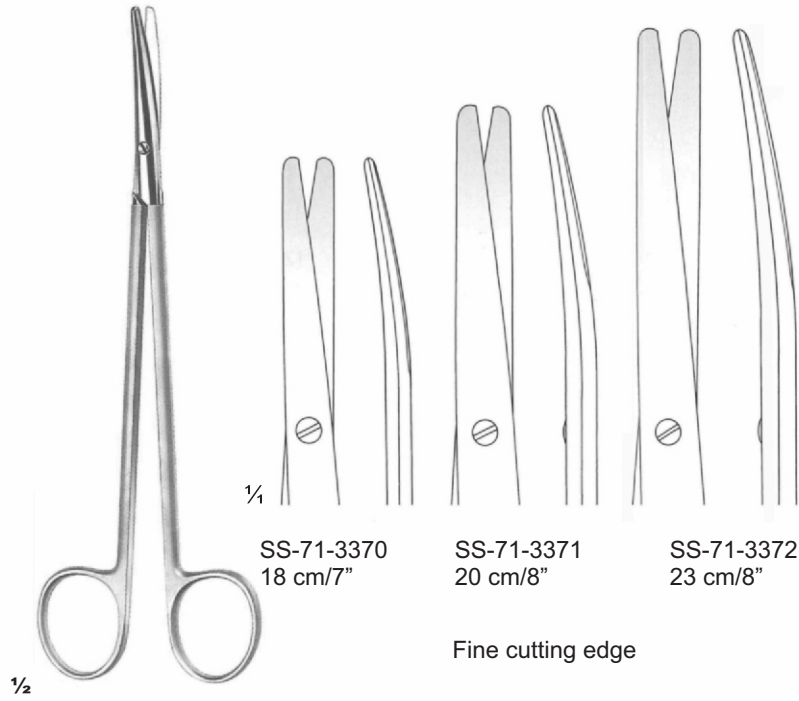
Wagner
12 cm/4 3/4"





Ragnell

Gum scissors ● EN
 Zahnfleschscheren ● DE
 Tijeras para encías ● ES



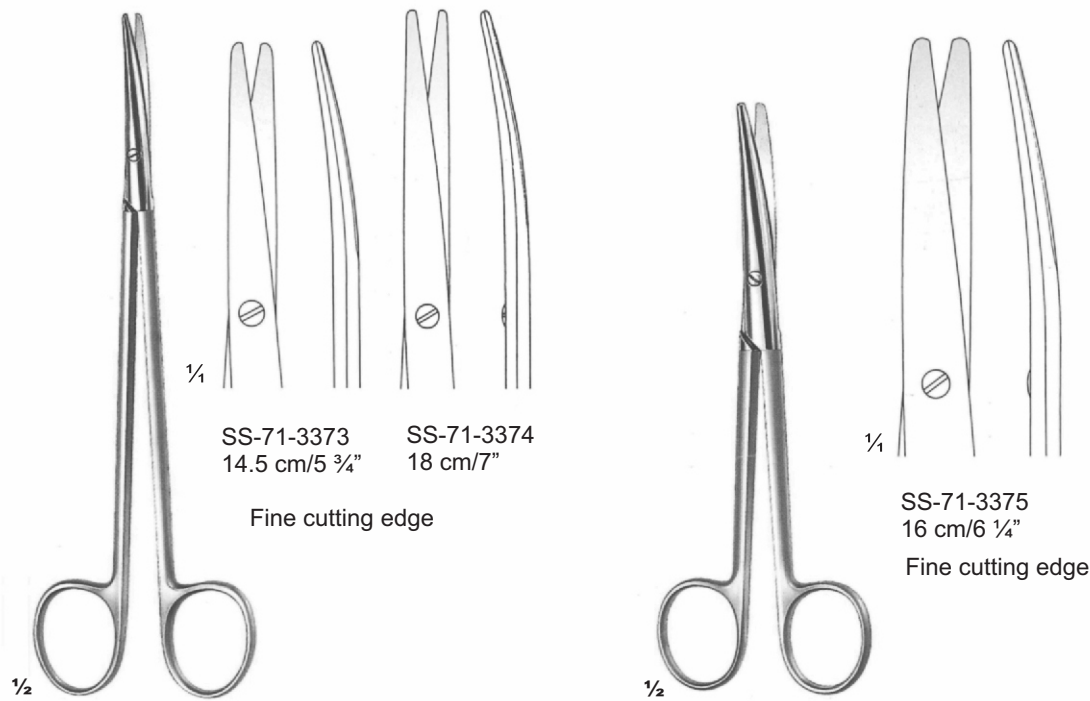
SS-71-3370
18 cm/7"

SS-71-3371
20 cm/8"

SS-71-3372
23 cm/8"

Fine cutting edge

Metzenbaum



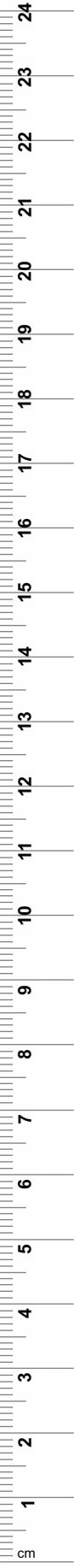
SS-71-3373
14.5 cm/5 3/4"

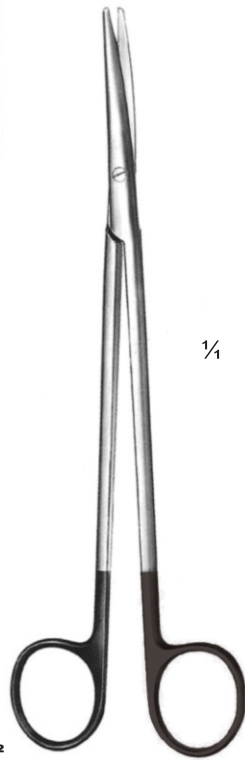
SS-71-3374
18 cm/7"

SS-71-3375
16 cm/6 1/4"
Fine cutting edge

Metzenbaum

Mayo-Lexer
Standard Pattern





1/4



SS-71-3376 TCS
14.5 cm/5 3/4"

SS-71-3377 TCS
18 cm/7"

For synthetic suture material
One toothed cutting edge



1/4



SS-71-3378 TCS
14.5 cm/5 3/4"

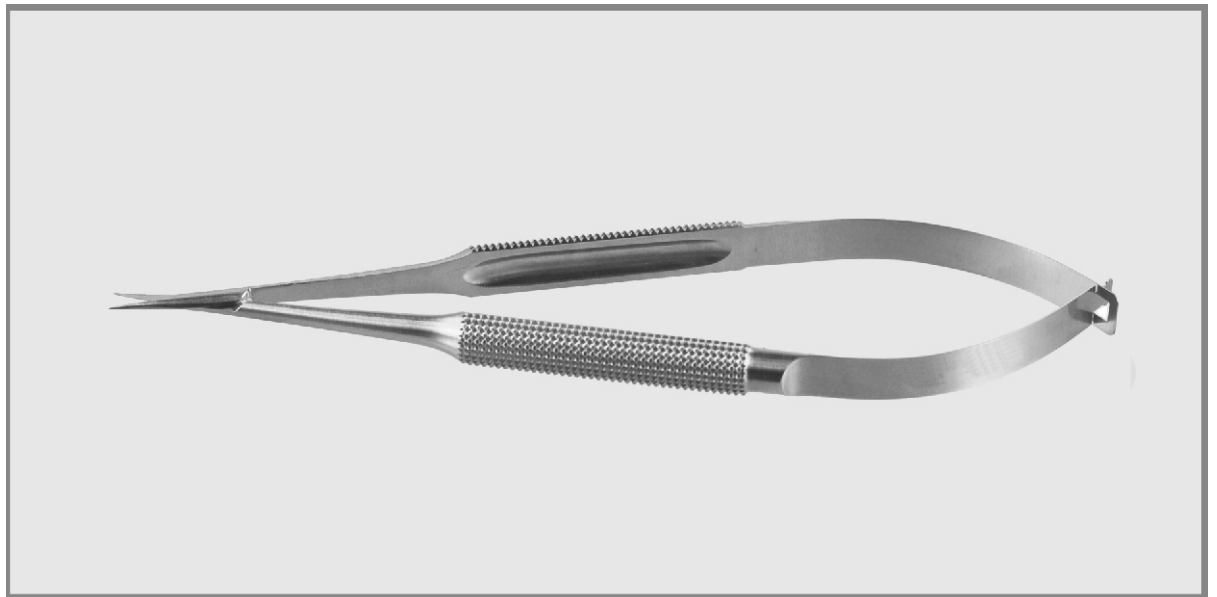
SS-71-3379 TCS
17 cm/6 3/4"

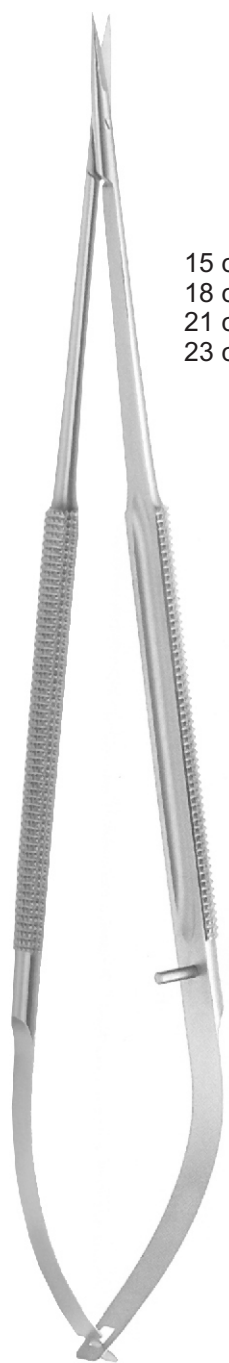
For synthetic suture material
One toothed cutting edge

72

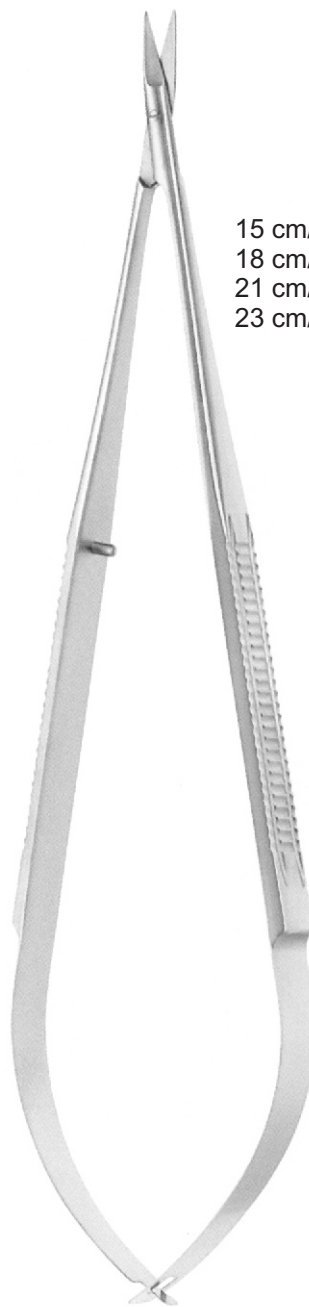
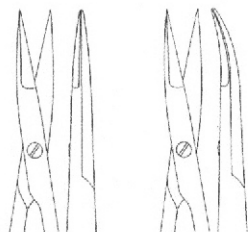
- EN** Micro Scissors
- DE** Mikroschere
- ES** Micro tijeras

Page 172 to 173

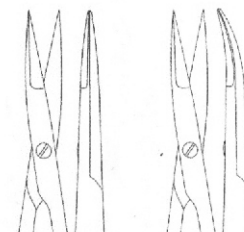




15 cm/6"	SS-72-3401	SS-72-3405
18 cm/7"	SS-72-3402	SS-72-3406
21 cm/8 1/4"	SS-72-3403	SS-72-3407
23 cm/9"	SS-72-3404	SS-72-3408



15 cm/6"	SS-72-3409	SS-72-3413
18 cm/7"	SS-72-3410	SS-72-3414
21 cm/8 1/4"	SS-72-3411	SS-72-3415
23 cm/9"	SS-72-3412	SS-72-3416



Streamlined



Streamlined

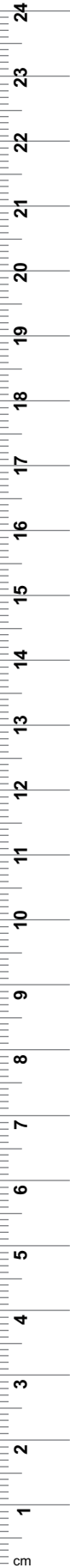
72

MICRO SCISSORS

Micro Scissors ● EN
Mikroscheren ● DE
Micro-ciseaux ● ES



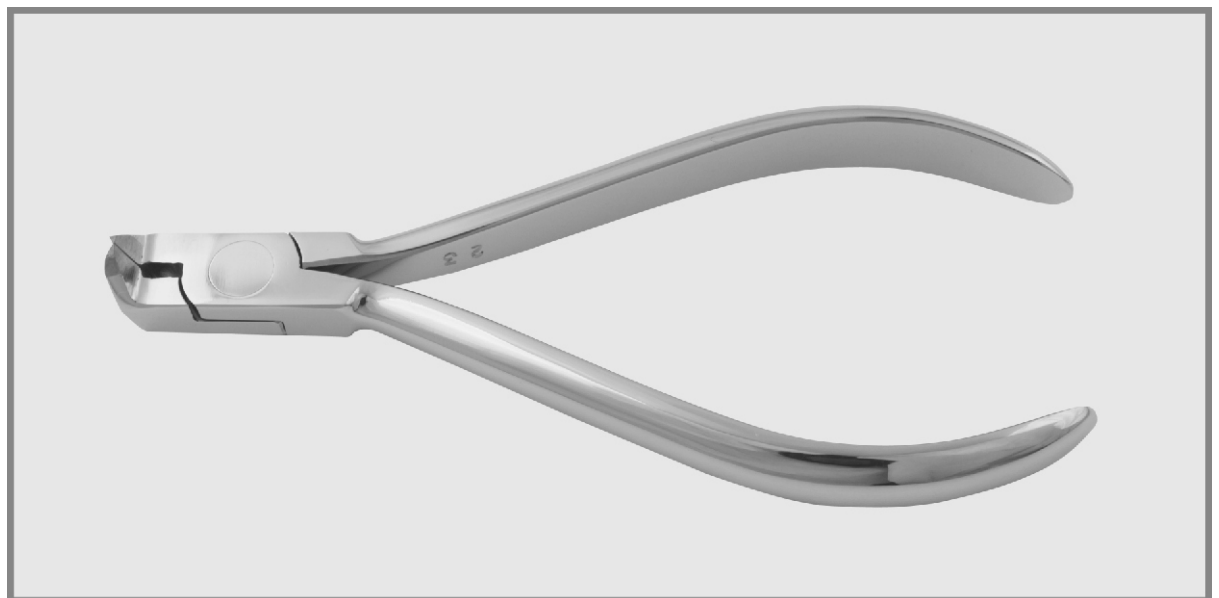
NOYES
SS-72-3417
13 cm/5"



73

- EN** Orthodontics
- DE** Kieferorthopädie
- ES** Ortodoncia

Page 174 to 190





SS-73-3501
14 cm/5 1/2"



LANGENBECK
SS-73-3502
15 cm/6"



SS-73-3503
14 cm/5 1/2"



SS-73-3504
12,5 cm/4 3/4"



SS-73-3505
13 cm/5"



SS-73-3506
14 cm/5 1/2"

Flat nose pliers, Wire bending pliers ● EN
 Rund-, Flachzange, Drahtbiegezange ● DE
 Pincés plates, rondes, Pince pour technique ● ES



GOSLEE
 SS-73-3507
 14 cm/5 1/2"



GOSLEE
 SS-73-3508
 14 cm/5 1/2"



GOSLEE
 SS-73-3509
 14 cm/5 1/2"



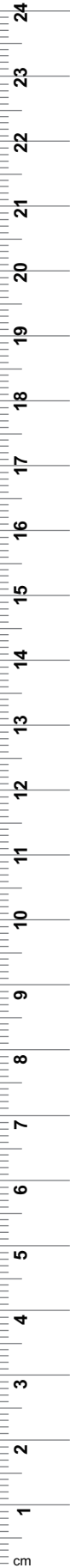
SS-73-3510
 12,5 cm/4 3/4"



SS-73-3511
 15 cm/6"



SS-73-3512
 13 cm/5"





SS-73-3513
13 cm/5"



SS-73-3514
13 cm/5"



LANGENBECK
SS-73-3515
14 cm/5 1/2"



DUMONT
SS-73-3516
11,5 cm/4 1/2"



DUMONT
SS-73-3517
11,5 cm/4 1/2"



DUMONT
SS-73-3518
11,5 cm/4 1/2"

End and side nippers ● EN
 Zwickzangen ● DE
 Coupe-fil ● ES

Wire cutter, front action



SS-73-3519
11 cm/4 1/4"



SS-73-3520
11,5 cm/4 1/2"



SS-73-3521
12,5 cm/4 3/4"

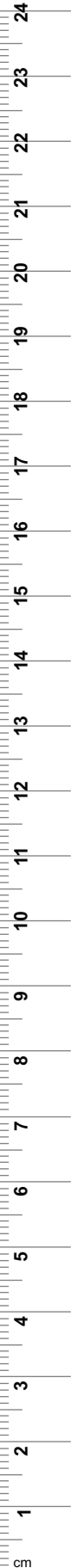


SS-73-3522
11,5 cm/4 1/2"



0,7 mmØ
for hard wire up to

SS-73-3523
11,5 cm/4 1/2"





1,0 mm Ø
 for hard wire up to

SS-73-3524
 15 cm/6"

SCHWARZ
 SS-73-3525
 13 cm/5"
 Modell I

SCHWARZ
 SS-73-3526
 13 cm/5"
 Modell II

SCHWARZ
 SS-73-3527
 13 cm/5"
 Modell III

SCHWARZ
 SS-73-3528
 14,5 cm/5 ¾"

FISCHER
 SS-73-3529
 14 cm/5 ½"



ANDRESEN
 SS-73-3530
 13,5 cm/5 1/2"

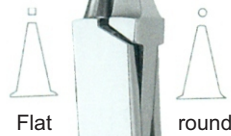


STADLER
 SS-73-3533
 15 cm/6"



●
 sling forming pliers

McKELLOPS
 SS-73-3531
 17 cm/6 3/4"



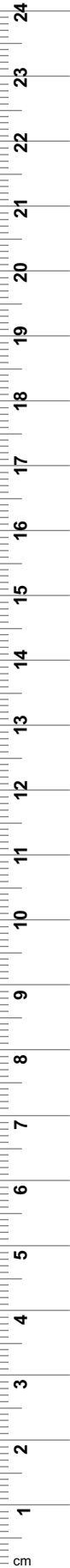
ANGLE
 SS-73-3534
 12,5 cm/5"



McKELLOPS-
 STADLER
 SS-73-3532
 16 cm/6 1/4"



ANGLE
 SS-73-3535
 12,5 cm/5"





ADAMS
 SS-73-3536
 13 cm/5"



YOUNG
 SS-73-3537
 13 cm/5"



TWEED
 SS-73-3538
 13,5 cm/5 1/2"



TWEED
 SS-73-3539
 13,5 cm/5 1/2"



DE LA ROSA
 SS-73-3540
 12,5 cm/5"

Contouring pliers



DE LA ROSA
 SS-73-3541
 12,5 cm/5"

Wire, arch and clasp bending pliers • EN
 Draht-, Bogen- und Klammernbiegeezangen • DE
 Pincès à courber les fils, les branches et les agrafes • ES



JARABAK
 SS-73-3542
 14 cm/5 1/2"

ovalen Draht bis
 hart 1,5 x 0,75 mm
 oval wire up to
 1.5 x 0.75 mm



ADERER
 SS-73-3543
 14 cm/5 1/2"

0,7 mm Ø
 hard wire up to

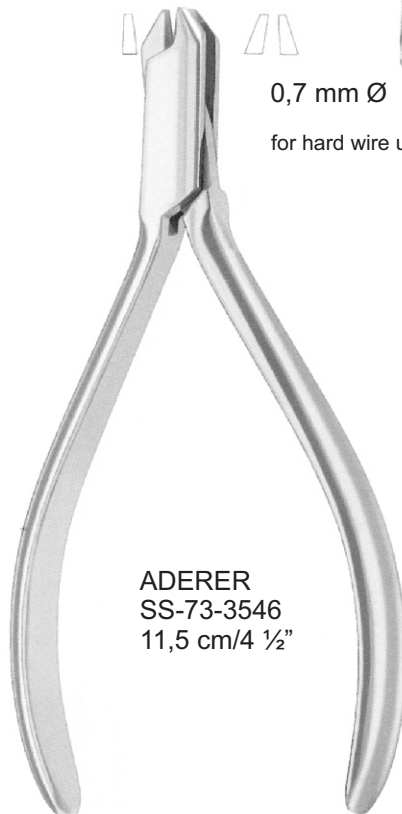


KOEHLER
 SS-73-3544
 12 cm/4 3/4"



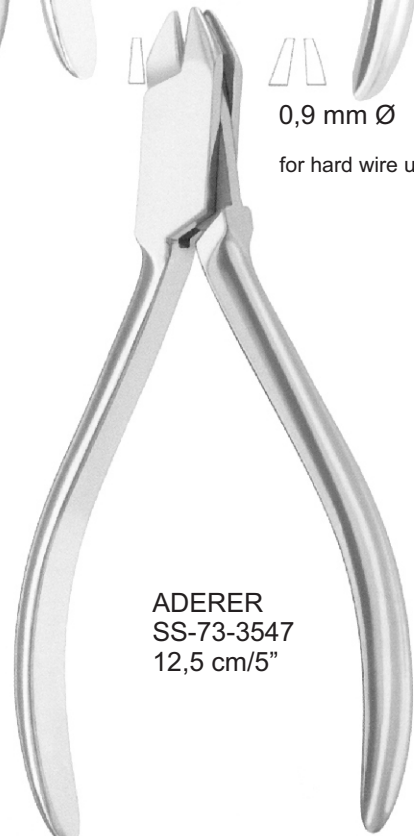
SS-73-3545
 14 cm/5 1/2"

0,7 mm Ø
 for hard wire up to



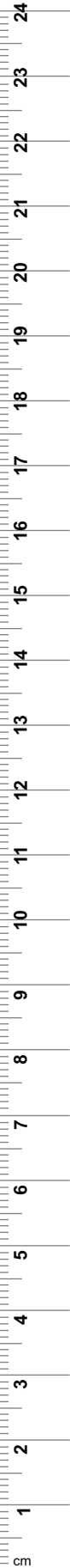
ADERER
 SS-73-3546
 11,5 cm/4 1/2"

0,7 mm Ø
 for hard wire up to

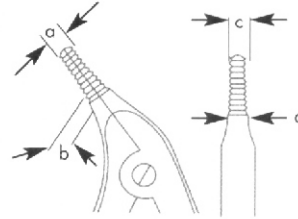


ADERER
 SS-73-3547
 12,5 cm/5"

0,9 mm Ø
 for hard wire up to

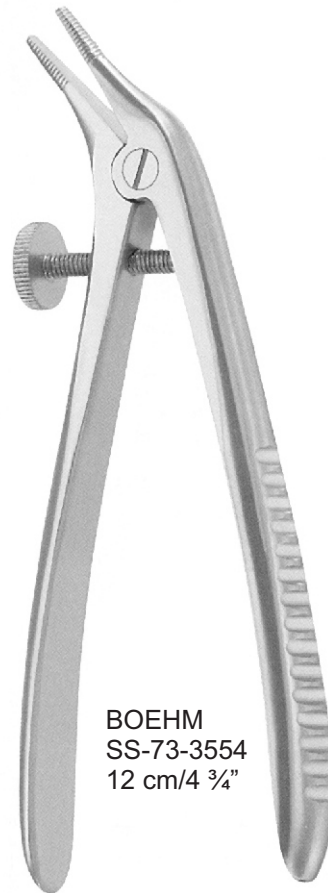






a	b	c	d
3,3	4	2,3	3,0
4,4	5	3,4	3,8

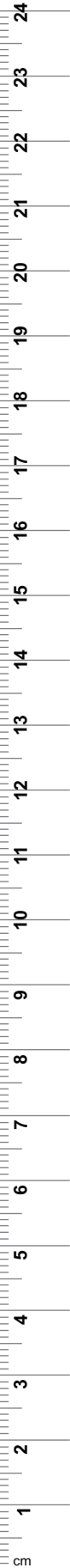
Telescope crown pliers



BOEHM
 SS-73-3554
 12 cm/4 3/4"



BOEHM
 SS-73-3555
 15 cm/4"





OLIVER
 JONES
 SS-73-3556
 15 cm/6"



OLIVER
 SS-73-3557
 15 cm/6"



OLIVER
 SS-73-3558
 15 cm/6"

Step loop bending pliers



ADERER
 SS-73-3559
 13,5 cm/5 1/4"

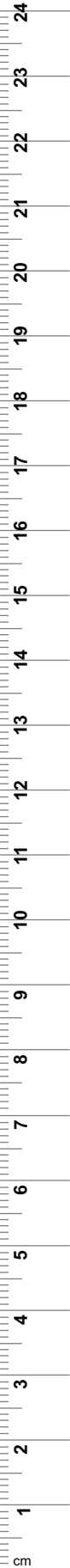


NANCE
 SS-73-3560
 12,5 cm/5"



0,7 mm Ø

for hard wire up to





TRYFUS
 SS-73-3567
 16 cm/6 1/4"

Crown stretching pliers



PEESO
 SS-73-3570
 14 cm/5 1/2"



smooth

PEESO
 SS-73-3568
 12 cm/6 1/4"



straight

HOW
 SS-73-3571
 14 cm/5 1/2"



serrated

PEESO
 SS-73-3569
 13,5 cm/5 1/4"



curved

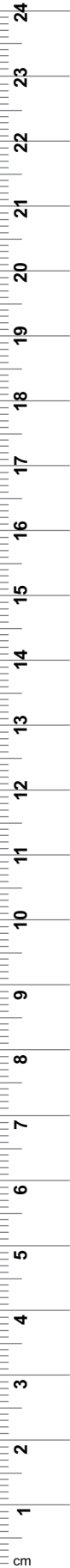
HOW
 SS-73-3572
 14 cm/5 1/2"

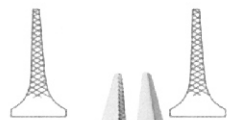


SS-73-3573
18 cm/7"



SS-73-3574
14,5 cm/5 3/4"





FREVERT
 SS-73-3575
 12 cm/4 ¾"



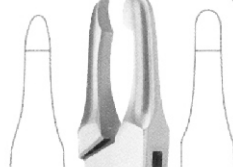
TRIPLEX
 SS-73-3576
 14 cm/5 ½"



REYNOLD
 SS-73-3577
 12 cm/4 ¾"



GORDON
 SS-73-3578
 13,5 cm/5 ¼"



JOHNSON
 SS-73-3579
 13 cm/5"

Bracket Positioning Forceps ● EN

Klebebracketpinzetten ● DE

Pince pour le positionnement de bracket ● ES

Clamping tweezer / bracket holder



SS-73-3580

SS-73-3581

SS-73-3582

SS-73-3583

SS-73-3584

SS-73-3585

SS-73-3586

SS-73-3587
Bracket
P. Gauge

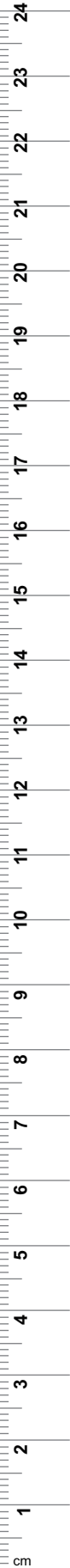
SS-73-3588
Band Remover

SS-73-3589
Band Remover

Bracket positioning gauge



SS-73-3590





SS-73-3591
12.5 cm/5"



SS-73-3592
12.5 cm/5"



SS-73-3593
12.5 cm/5"



SS-73-3594
12.5 cm/5"



SS-73-3595
12.5 cm/5"



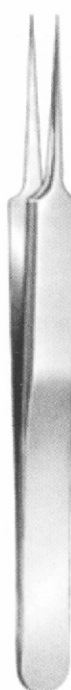
SS-73-3596
12.5 cm/5"



SS-73-3597
12.5 cm/5"



SS-73-3598
12.5 cm/5"



SS-73-3599
12.5 cm/5"



SS-73-3600
12.5 cm/5"



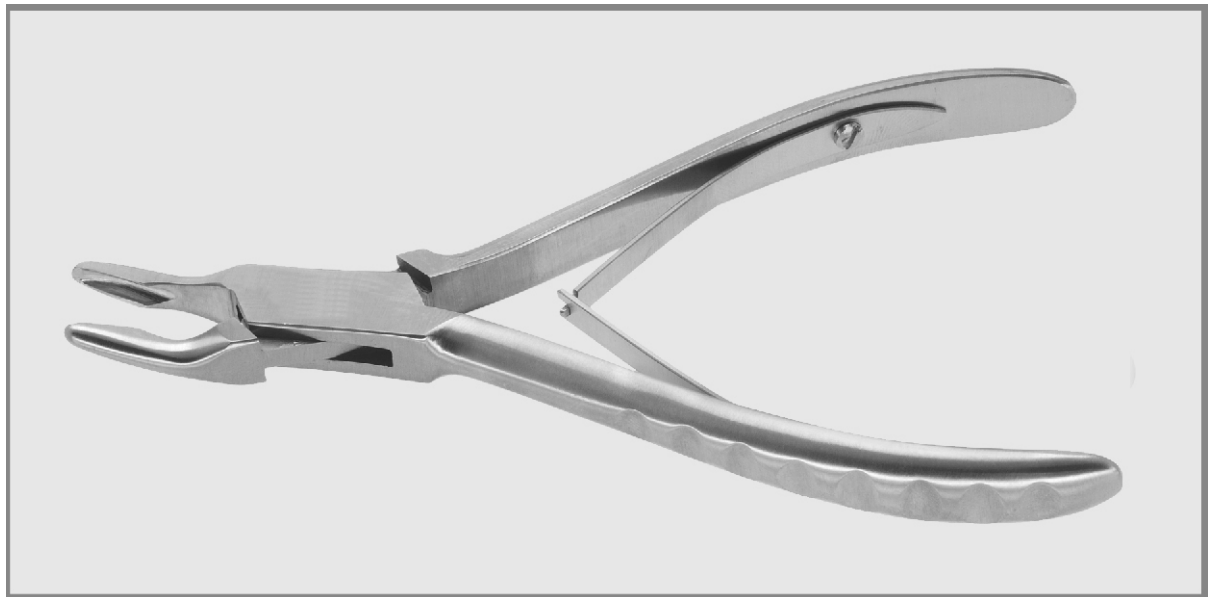
SS-73-3601
12.5 cm/5"

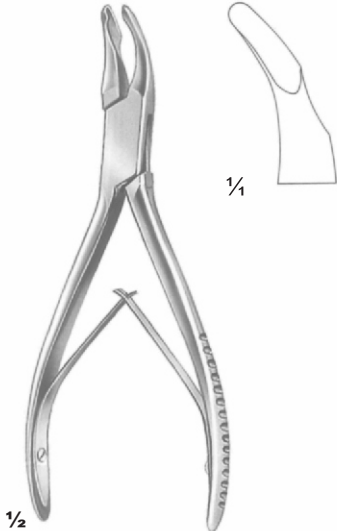


SS-73-3602
12.5 cm/5"

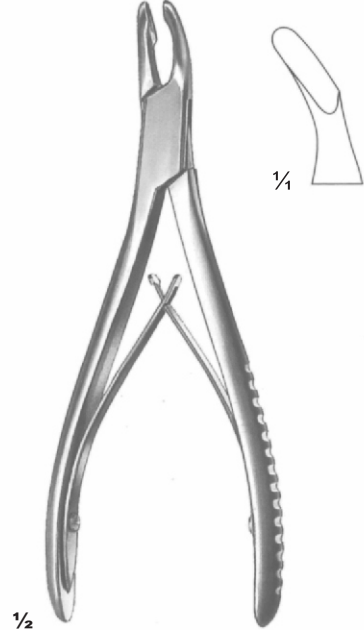
74

- EN** Bone Rongeurs
- DE** Knochen Rongeure
- ES** Rongeurs de hueso

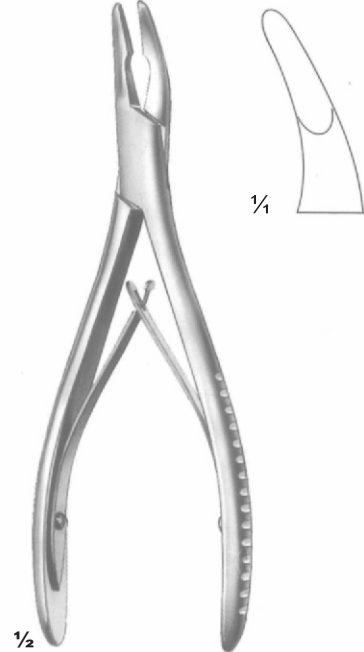




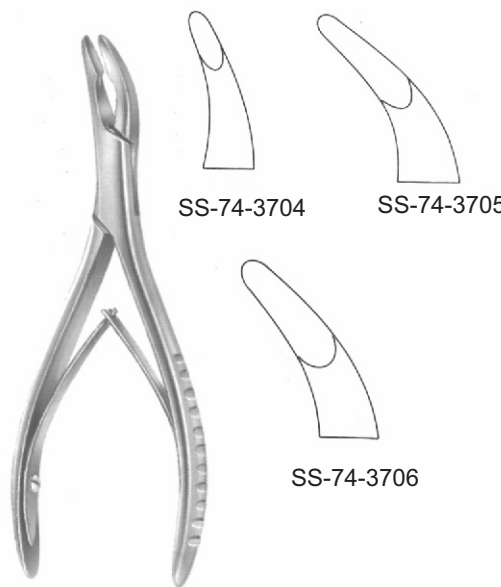
Cleveland
 SS-74-3701
 15 cm



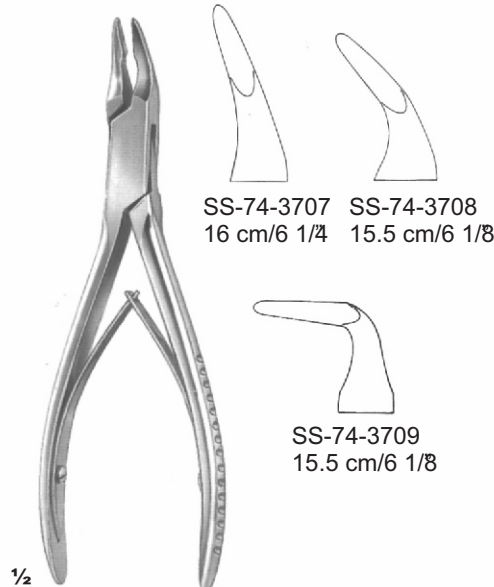
Cleveland
 SS-74-3702
 15 cm



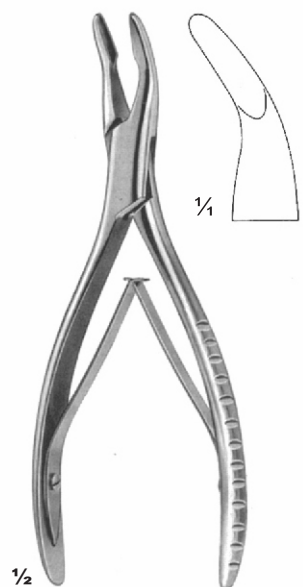
Hartmann
 SS-74-3703
 18 cm



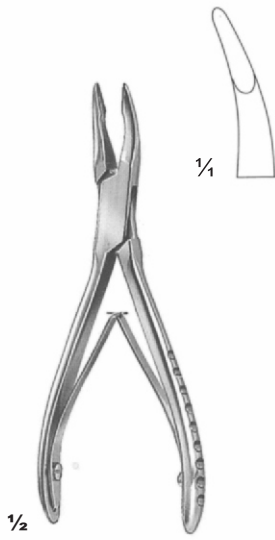
LUER
 15 cm



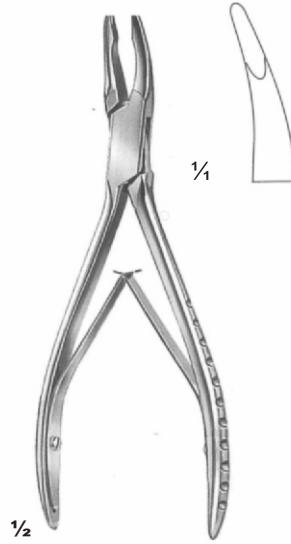
BLUMENTHAL
 15 cm



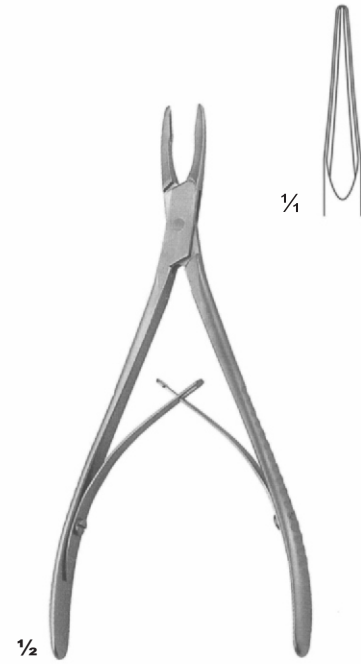
MEAD
 SS-74-3710
 16.5 cm/6 1/2"



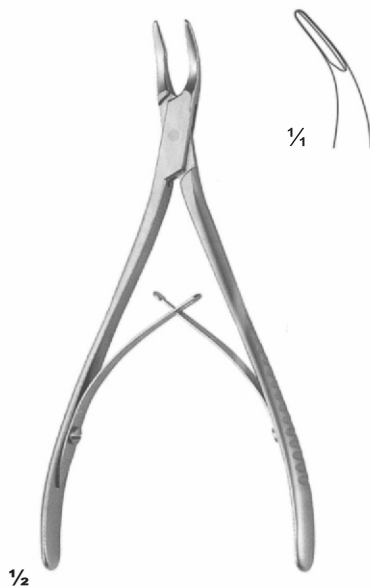
Friedmann
 SS-74-3711
 14 cm



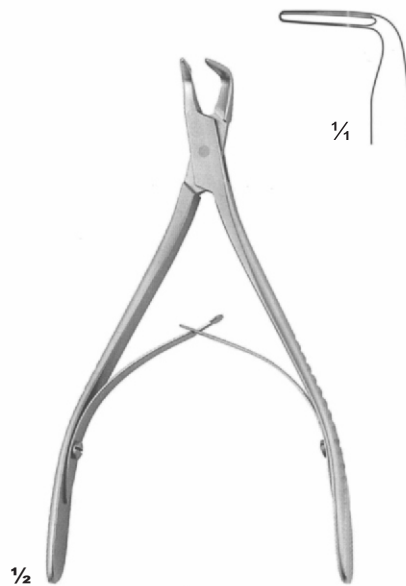
Friedmann
 SS-74-3712
 14 cm



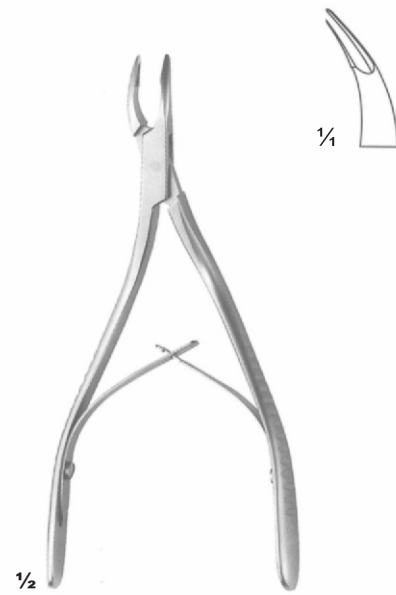
Friedmann-Micro
 SS-74-3713
 15 cm/6"
 straight



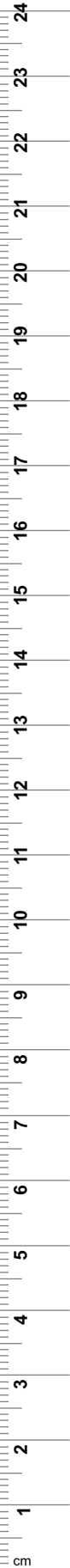
Friedmann-Micro
 SS-74-3714
 15 cm/6"
 30°



Friedmann-Micro
 SS-74-3715
 14.5 cm/5 3/4"
 90°



Friedmann-Micro
 SS-74-3716
 14.5 cm/5 3/4"
 S shape
 30°



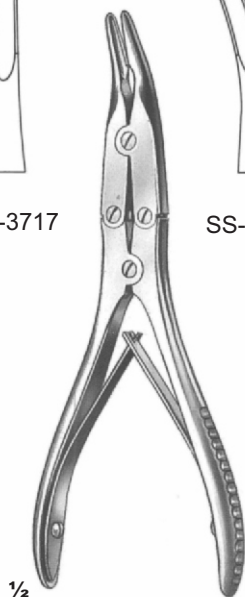


1/4

SS-74-3717



SS-74-3718



1/2

Bohler
15.5 cm/6"



1/4



1/2

Beyer
SS-74-3719
18 cm/7"



1/4

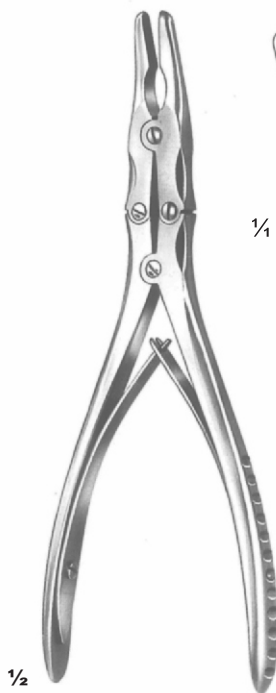


1/2

Mayfield
SS-74-3720
18 cm/7"



1/4



1/2

Zaufal-Jansen
SS-74-3721
18 cm/7"



1/4



1/2

Ruskin
SS-74-3722
19 cm/7 1/2"

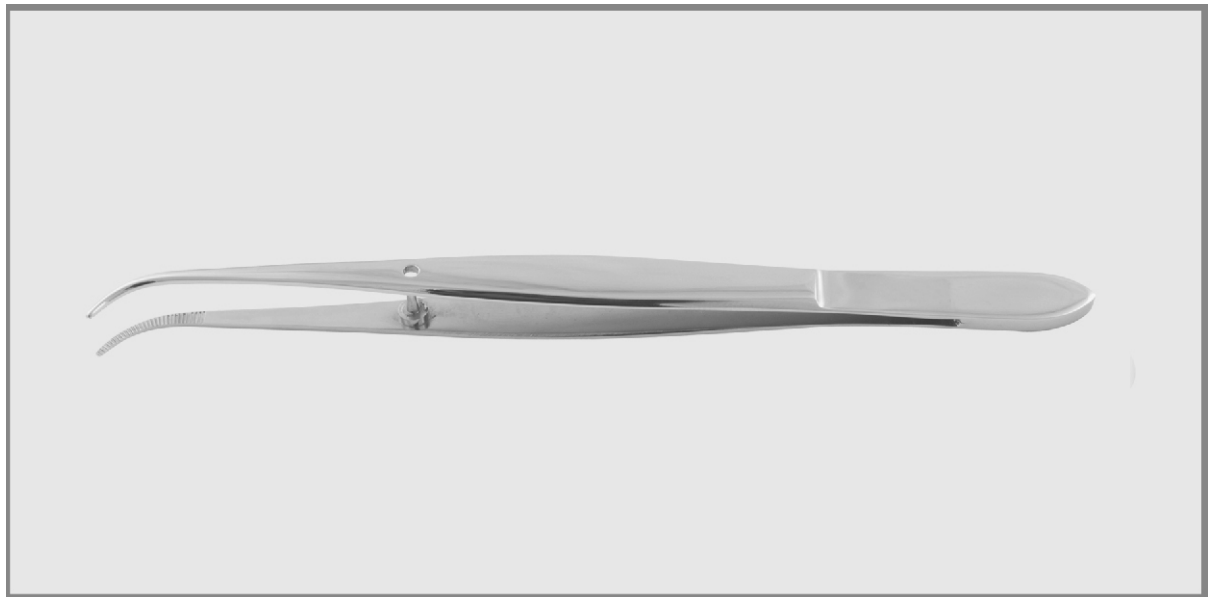
75

EN Forceps

DE Zange

ES Fórceps

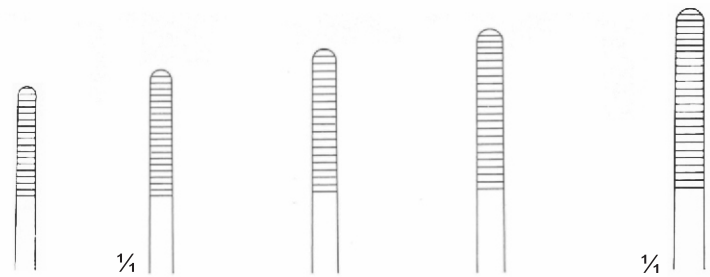
Page 194 to 201





standard pattern

1/2

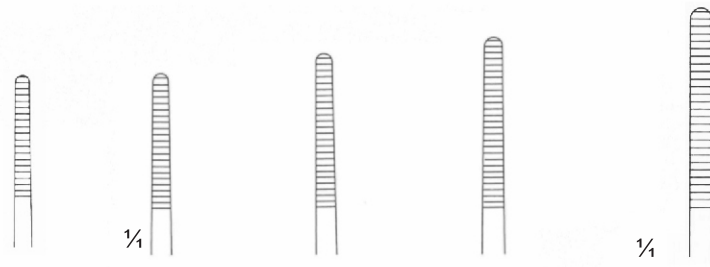


- SS-75-3801
13 cm/5 1/8"
- 1/4
- SS-75-3802
14.5 cm/5 3/4"
- SS-75-3803
16 cm/5 1/4"
- SS-75-3804
18 cm/7"
- 1/4
- SS-75-3805
20 cm/7 7/8"

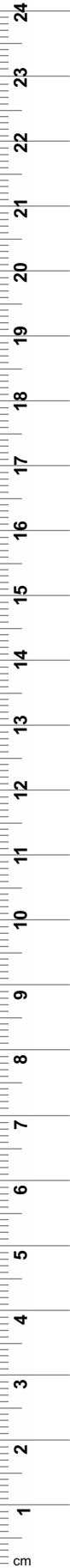
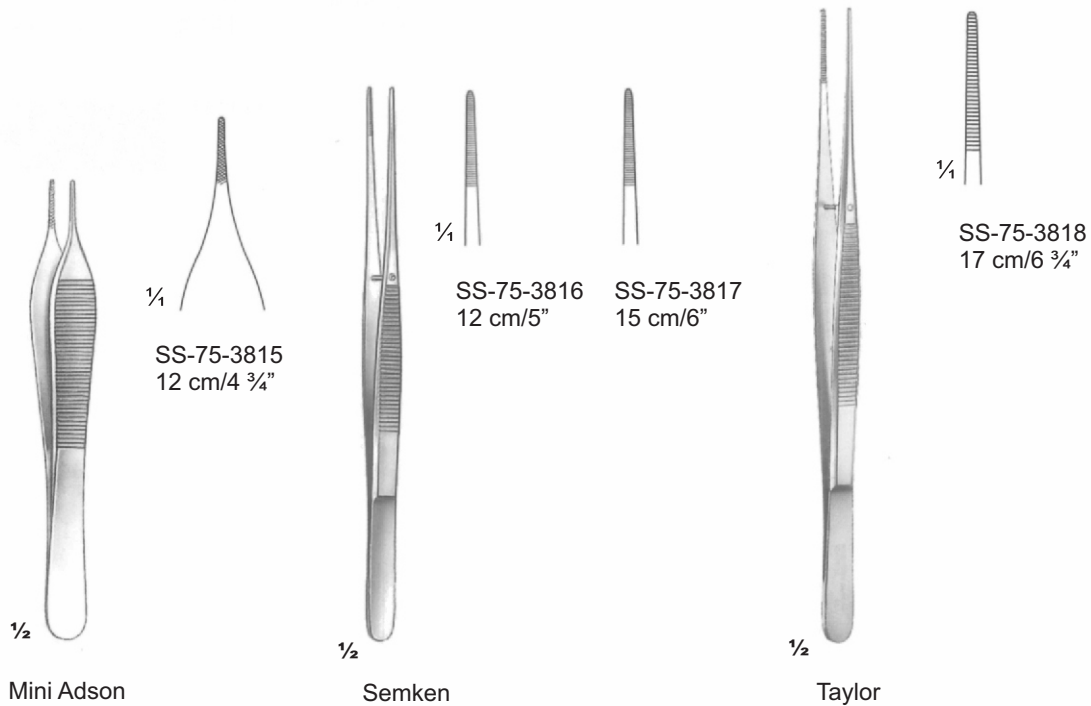
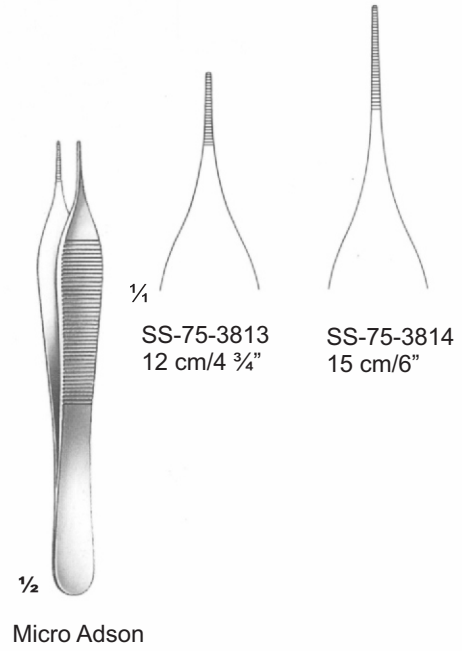
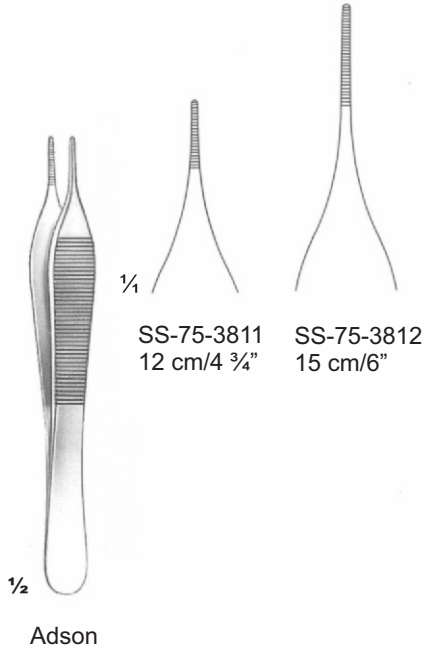


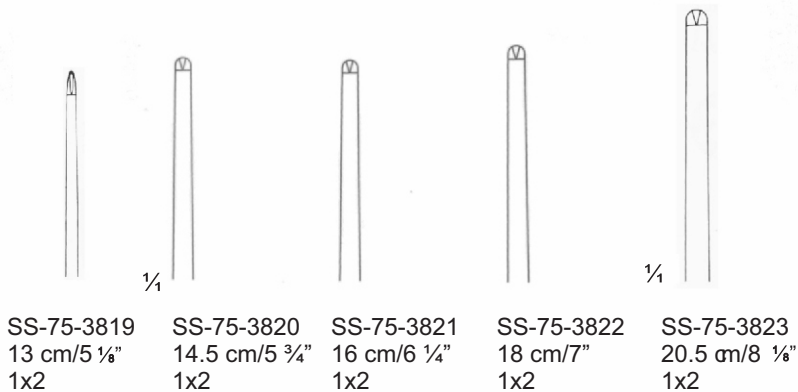
slender pattern

1/2

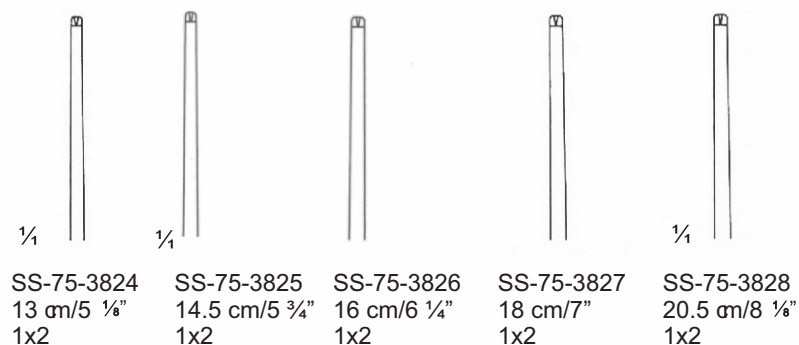


- SS-75-3806
13 cm/5 1/8"
- 1/4
- SS-75-3807
14.5 cm/5 3/4"
- SS-75-3808
16 cm/5 1/4"
- SS-75-3809
18 cm/7"
- 1/4
- SS-75-3810
20 cm/7 7/8"

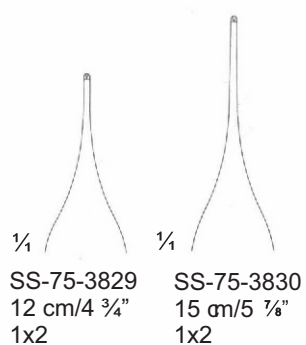




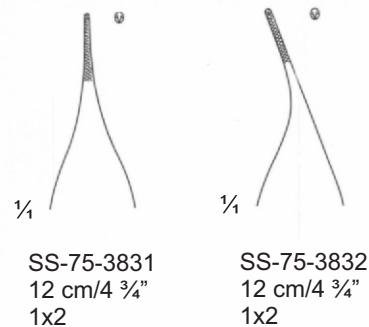
Standard Pattern



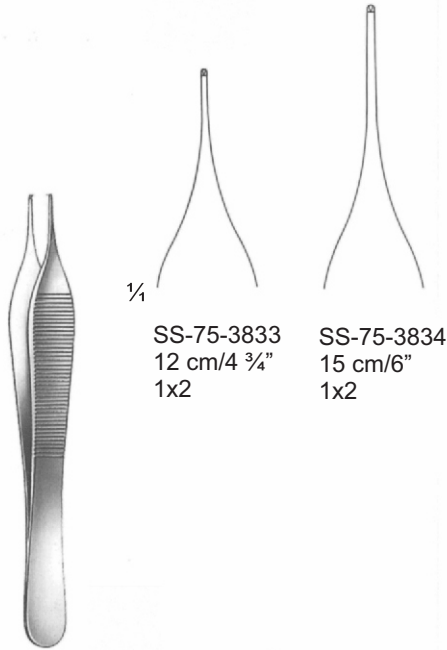
Slender Pattern



Adson



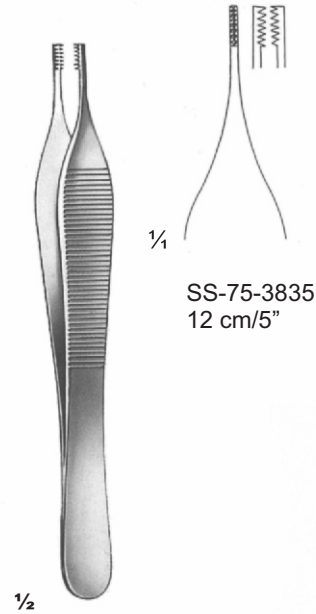
Mini Adson



1/4
 SS-75-3833
 12 cm/4 3/4"
 1x2

SS-75-3834
 15 cm/6"
 1x2

Mikro Adson



1/4
 SS-75-3835
 12 cm/5"

1/2

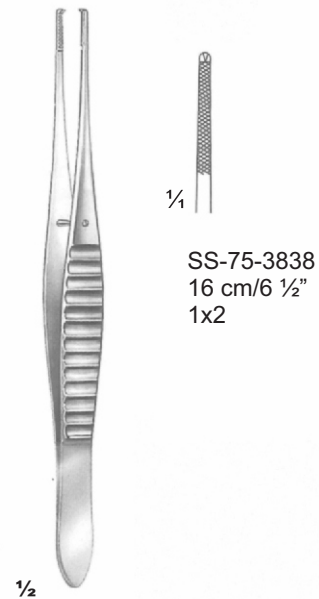
Adson-Brown



1/4
 SS-75-3836
 12.5 cm/5"
 1x2

SS-75-3837
 15 cm/6"
 1x2

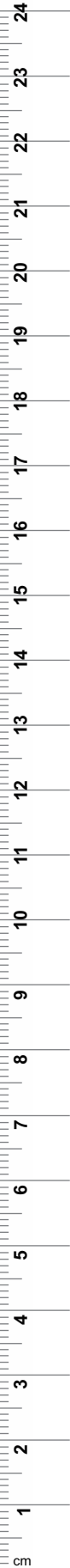
Semken



1/4
 SS-75-3838
 16 cm/6 1/2"
 1x2

1/2

Gillies





1/4
 SS-75-3838A
 15 cm/6"

suited to hold silver pins, nerve-broaches and for introducing medicines



1/2

Suture and membrane forceps

D = 1,6 mm



1/4

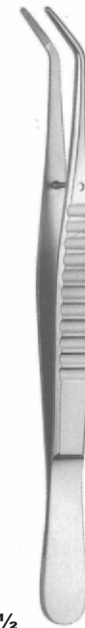
SS-75-3839
 16 cm/6 1/4"

D = 2,2 mm



1/4

SS-75-3840
 16 cm/6 1/4"



1/2



1/4

SS-75-3841
 16 cm/6 1/4"

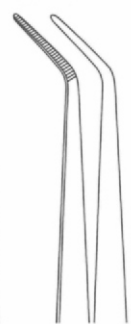


1/2
 London-College
 15 cm/6"



1/4

SS-75-3842
 No. 1



SS-75-3843
 No. 3



SS-75-3844
 No. 5



1/2

London-College
 with lock
 15 cm/6"

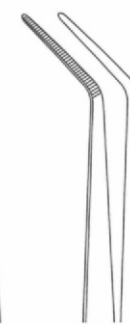


1/4

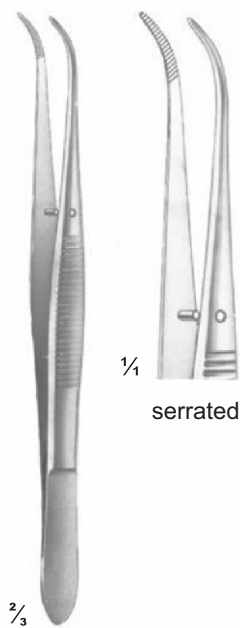
SS-75-3845
 No. 1



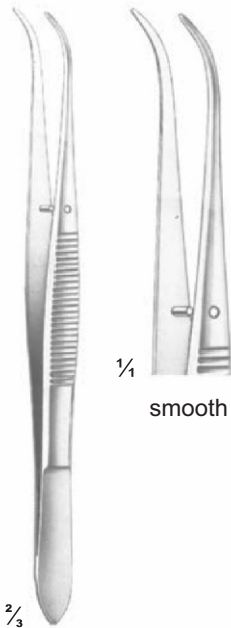
SS-75-3846
 No. 3



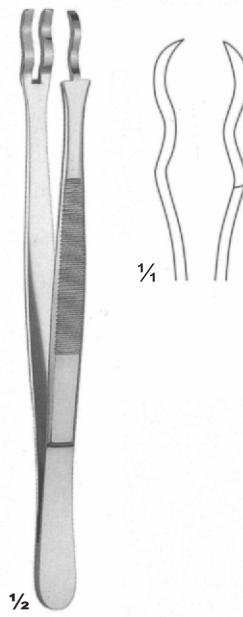
SS-75-3847
 No. 5



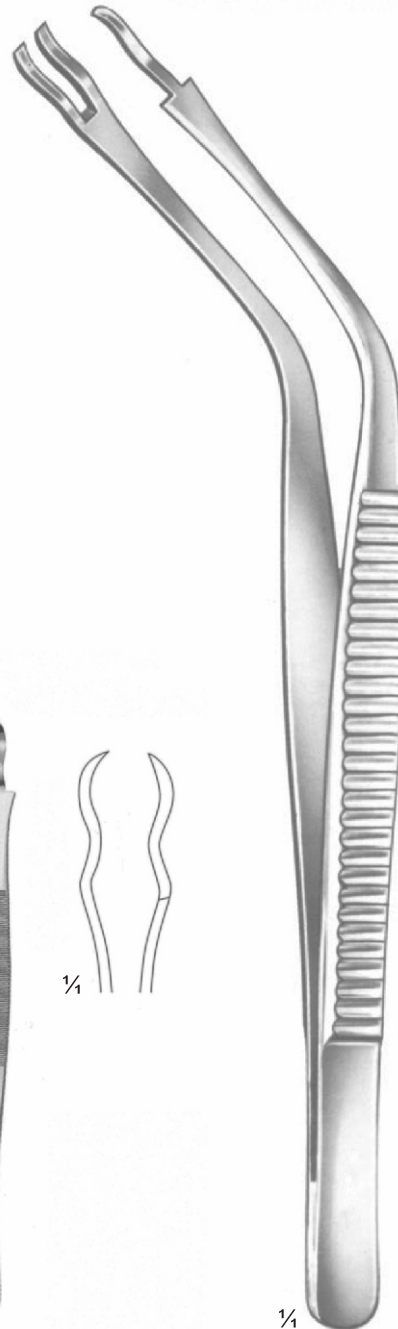
$\frac{2}{3}$
 Perry
 SS-75-3848
 13 cm/5"



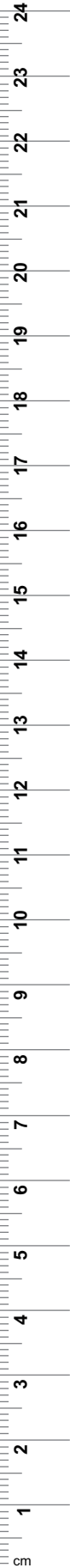
$\frac{2}{3}$
 Perry
 SS-75-3849
 13 cm/5"

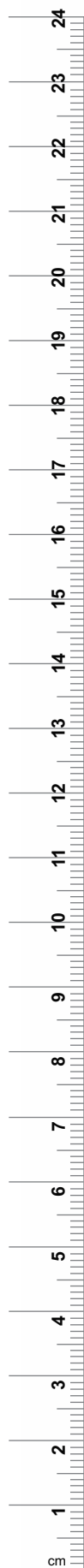


$\frac{1}{2}$
 SS-75-3850
 14.5 cm/5 $\frac{3}{4}$ "
 Frigz
 Grasping and
 sterilizing forceps



$\frac{1}{4}$
 SS-75-3851
 20 cm/8"
 Seizing and
 Sterilizing Forceps





DeBakey
12 cm/5"



SS-75-3852
2,7 mm



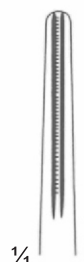
SS-75-3853
1,5 mm



SS-75-3854
2,0 mm



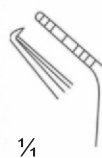
SS-75-3855
2,0 mm



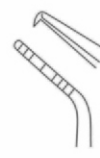
SS-75-3856
3,5 mm



Crane-Kaplan
Pocket marking forceps
15 cm/6"



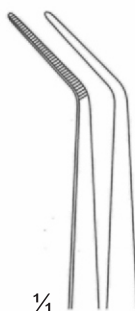
SS-75-3857
No. 1



SS-75-3858
No. 2



Meriam
16 cm/6 1/4"



SS-75-3859
No. 1



SS-75-3860
No. 3



SS-75-3861
No. 5



Flagg
16 cm/6 1/4"



SS-75-3862
No. 1



SS-75-3863
No. 2



SS-75-3864
No. 3



SS-75-3865
No. 4



Standard

SS-75-3866 TC
 14.5 cm/5 3/4"

SS-75-3867 TC
 18 cm/ 7"



delicate

SS-75-3868 TC
 14.5 cm/5 3/4"

SS-75-3869 TC
 18 cm/7"



1/2

Adson



SS-75-3870 TC
 12 cm/4 3/4
 1x2



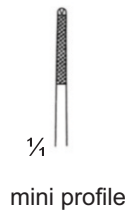
SS-75-3871 TC
 15 cm/6"
 1x2

mini profile



1/2

Gillies
 SS-75-3872 TC
 15.5 cm/6"
 1x2



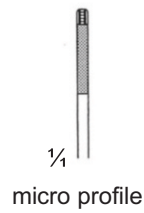
1/4
 mini profile



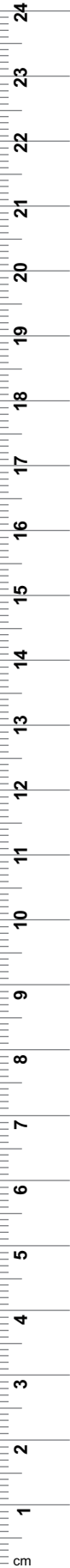
1/2

DeBakey
 SS-75-3873 TC
 16 cm/6 1/4"

ATRAUMA



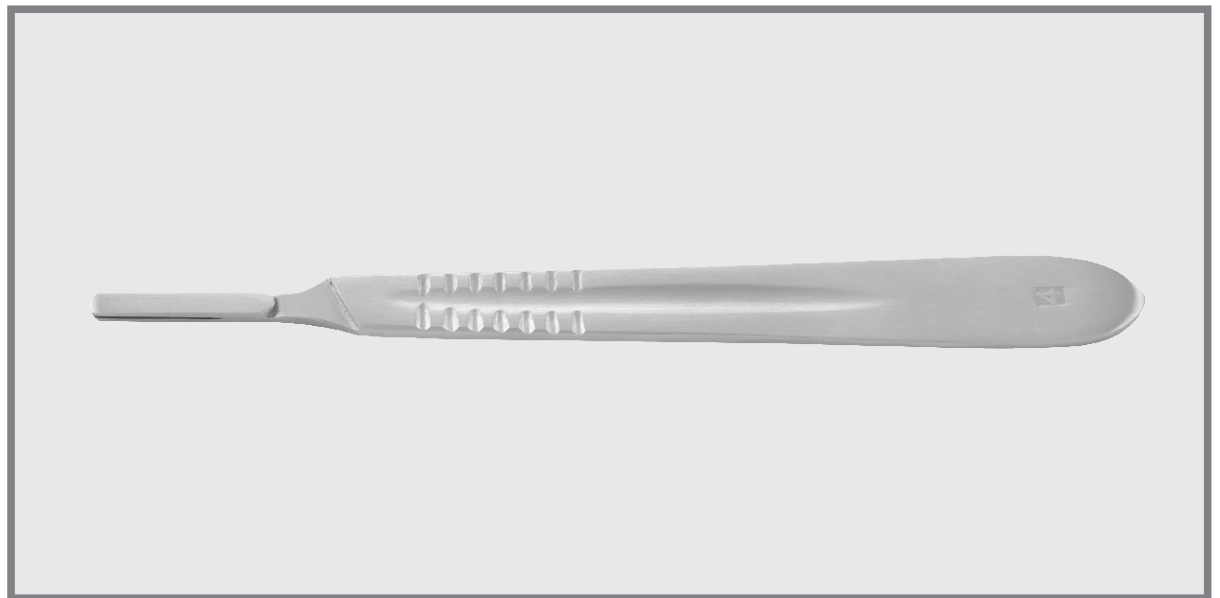
1/4
 micro profile

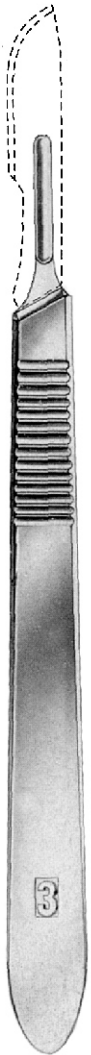


76

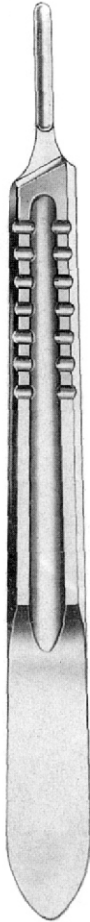
- EN** Scalpel Handles
- DE** Skalpellgriffe
- ES** Manches de bistouris

Page 202 to 203





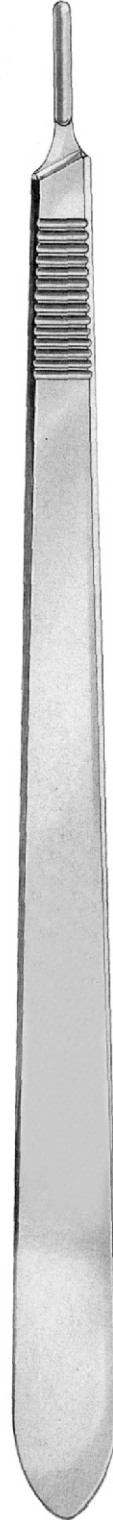
Standard
 SS-76-3901
 # 3



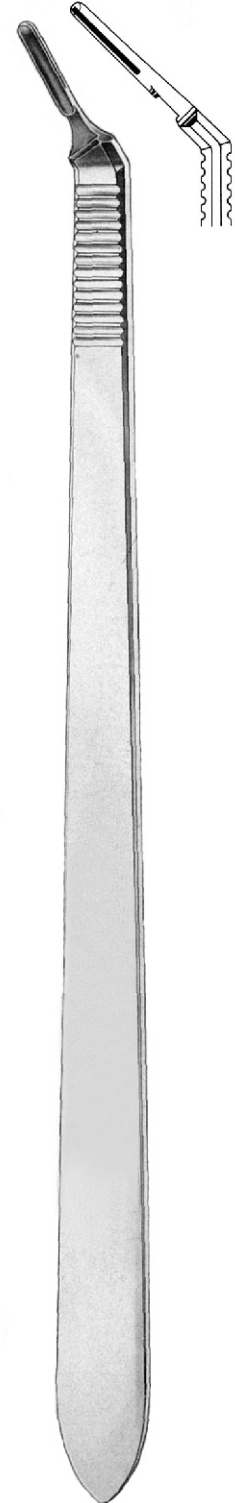
SS-76-3902
 # 3



SS-76-3903
 # 3
 with scale

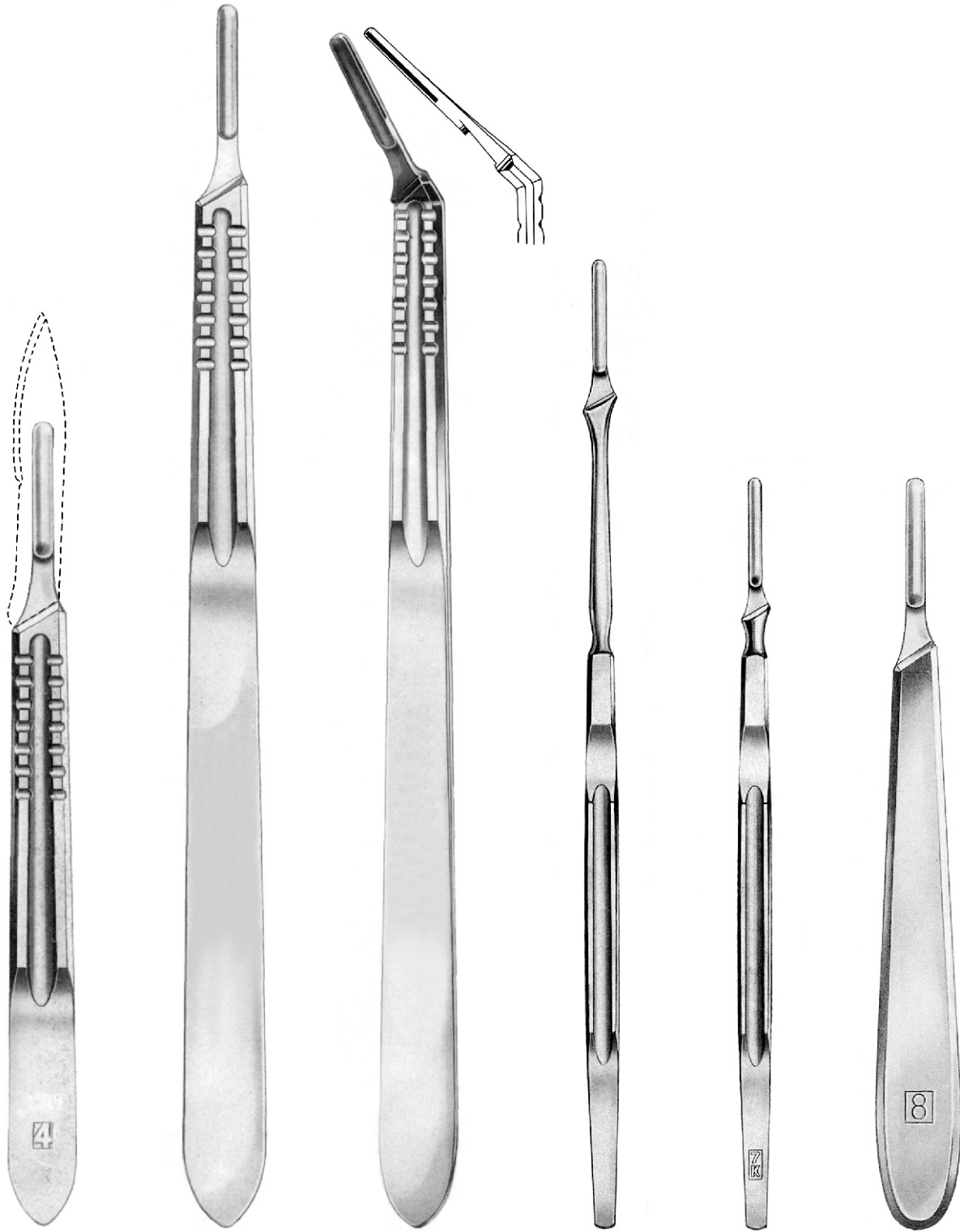


SS-76-3904-3L # 3L
 SS-76-3905-3XL # 3XL



SS-76-3906-3L # 3L
 SS-76-3907-3XL # 3XL
 angled

Scalpel Handles ● EN
 Skalpelli-Griffe ● DE
 Mangos de bisturios ● ES



Standard
 SS-76-3908
 # 4

SS-76-3909-4L # 4L
 SS-76-3910-4XL # 4XL

SS-76-3911-4L # 4L
 SS-76-3912-4XL # 4XL
 angled

SS-76-3913
 # 7

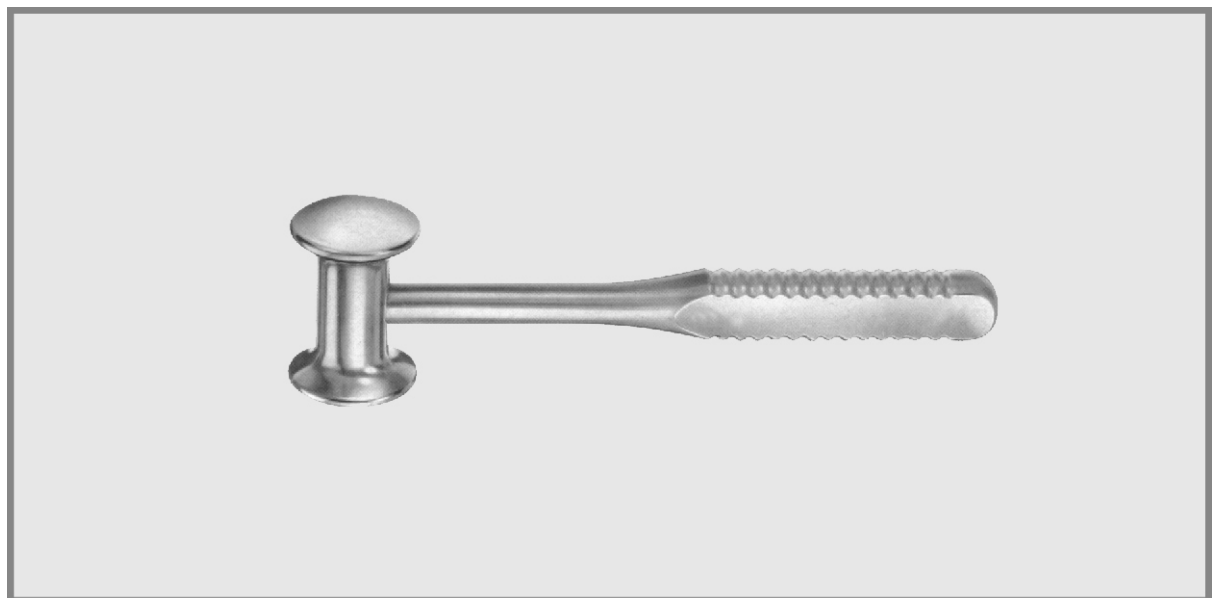
SS-76-3914
 # 7K

Collin
 SS-76-3915
 Fig. 8

77

- EN** Mallets
- DE** Schlägel
- ES** Mazos

Page 204 to 206

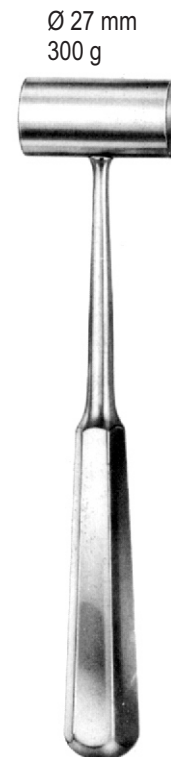
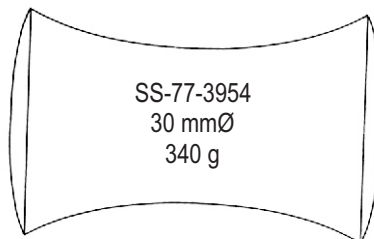
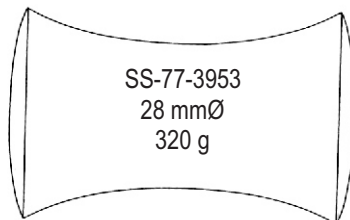
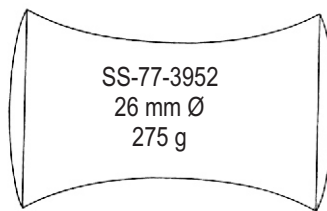




BERGMANN
 SS-77-3951
 24 cm/9 1/2"
 300 grams



WILLIGER
 24 cm/9 1/2"
 lead filled

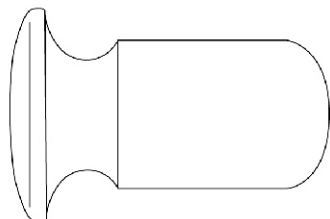
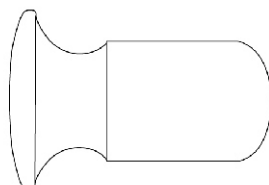
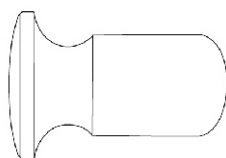


Ø 27 mm
 300 g

PARTSCH
 SS-77-3955
 18 cm/7 1/8"
 with hollow handle



DOYEN
 21 cm/8 1/4"



27 mm Ø
 300 g

with interchangeable
 plastic disks

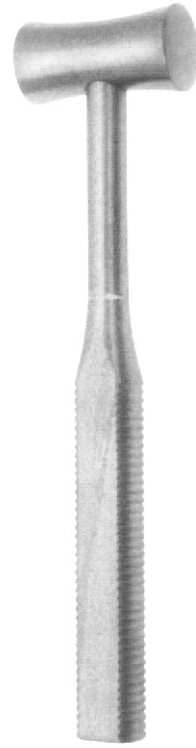
MEAD
 SS-77-3959 19 cm/7 1/2"
 SS-77-3960 pair of spare disks



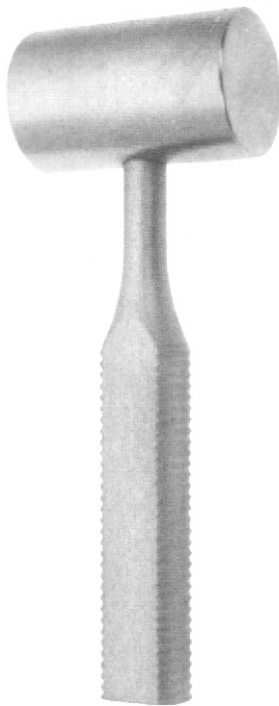
HAJEK
 SS-77-3961
 20 cm/7 7/8"
 200 g
 Ø 27 mm



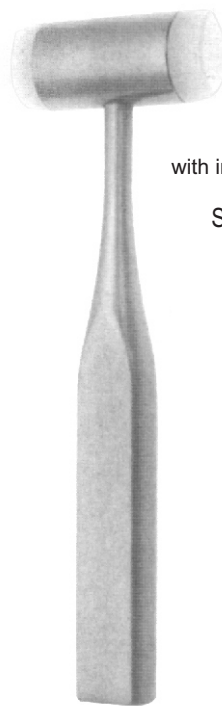
KIRK
 SS-77-3962
 21 cm/8 1/4"
 650 g
 Ø 38 mm



BERGMANN
 SS-77-3963
 24.5 cm/9 5/8"
 400 g
 Ø 30 mm

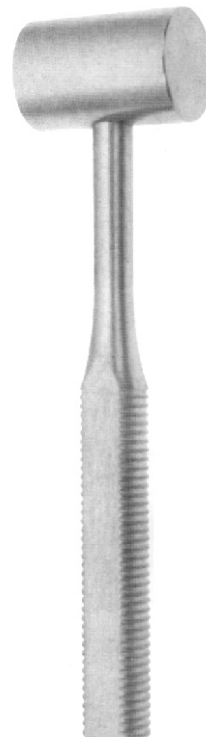


HEATH
 SS-77-3964
 18.5 cm/7 1/4"
 700 g
 Ø 40 mm

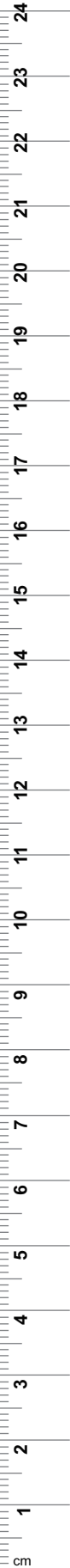


with interchangeable
 disks
 SS-77-3966

SS-77-3965
 18.5 cm/7 1/4"
 240 g
 Ø 25 mm

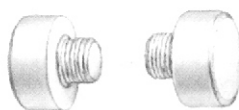


OMBREDANNE
 SS-77-3967
 24 cm/9 1/2"
 700 g
 Ø 40 mm

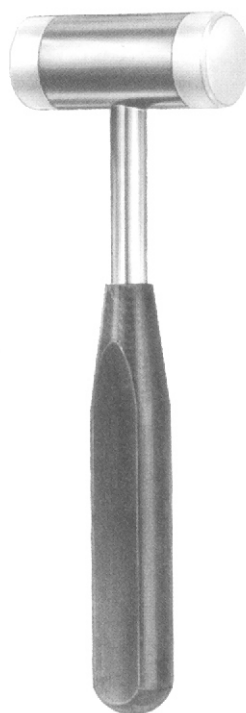




SS-77-3968
 26.5 cm/10 3/8"
 Ø 50 mm
 1300 g



SS-77-3969
 spare facings (pair)



SS-77-3970
 19 cm/7 1/2"
 Ø 25 mm
 300 g



HERBERT
SS-77-3971
 19 cm/7 1/2"
 Ø 25 mm
 215 g





78

- EN** Cassettes
- DE** Kassetten
- ES** Cassettes

Page 207 to 210





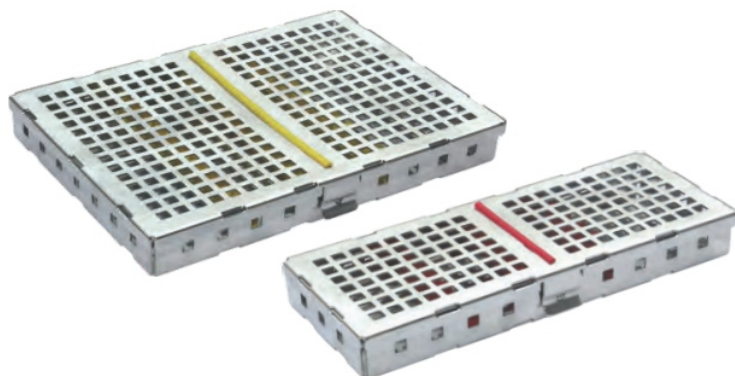
Elongated Holes

Dimension(mm)		
SS-78-4001	05-Instruments	78 x 182 x 32
SS-78-4002	10-Instruments	142 x 182 x 32
SS-78-4003	20-Instruments	270 x 182 x 32



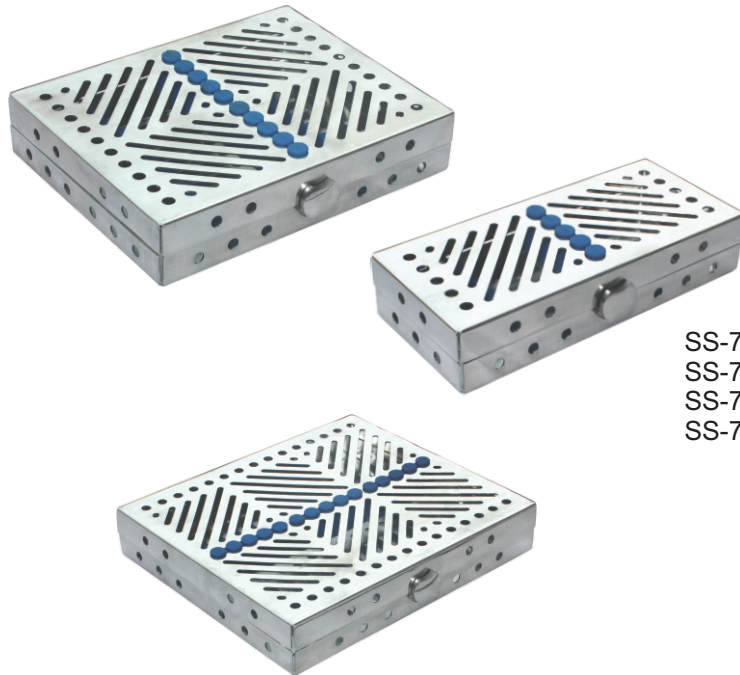
Round Bottom with Strip Lock

Dimension(mm)		
SS-78-4004	05-Instruments	90 x 182 x 25
SS-78-4005	10-Instruments	145 x 182 x 25
SS-78-4006	20-Instruments	270 x 182 x 25



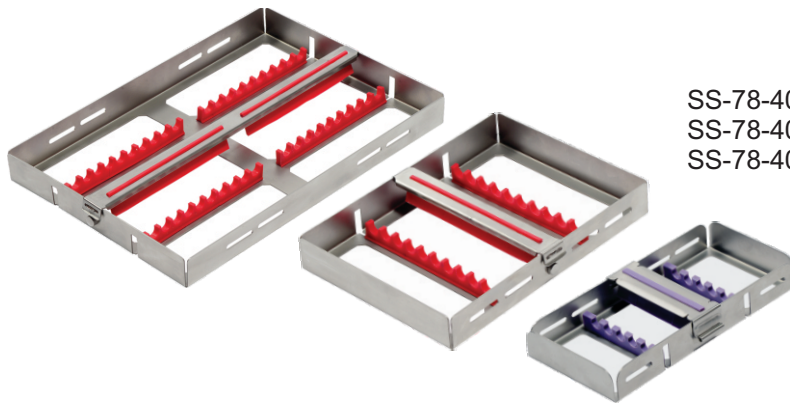
Square

Dimension(mm)		
SS-78-4007	05-Instruments	180 x 70 x 22
SS-78-4008	10-Instruments	180 x 130 x 22
SS-78-4009	20-Instruments	260 x 180 x 22



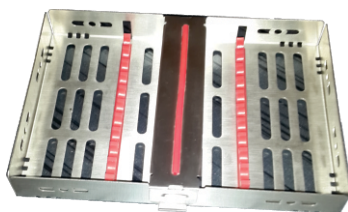
Elongated Holes

Model	Instruments	Dimension(mm)
SS-78-4010	05-Instruments	180 x 80 x 35
SS-78-4011	10-Instruments	180 x 145 x 35
SS-78-4012	15-Instruments	210 x 180 x 35
SS-78-4013	20-Instruments	280 x 180 x 35



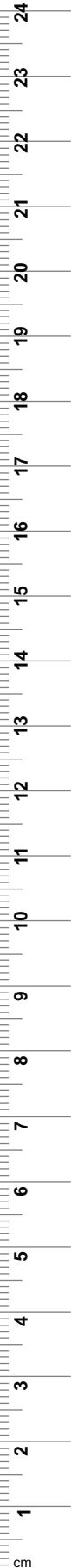
Strip Lock "H" Type

Model	Instruments	Dimension(mm)
SS-78-4014	05-Instruments	180 x 80 x 25
SS-78-4015	10-Instruments	180 x 130 x 25
SS-78-4016	20-Instruments	260 x 180 x 25



Strip Lock

Model	Instruments	Dimension(mm)
SS-78-4017	05-Instruments	180 x 80 x 25
SS-78-4018	10-Instruments	180 x 130 x 25
SS-78-4019	20-Instruments	260 x 180 x 25





	<u>Dimension(mm)</u>
SS-78-4020	405 x 255 x 50
SS-78-4021	405 x 255 x 70
SS-78-4022	405 x 255 x 100

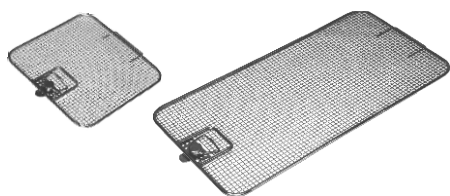


	<u>Dimension(mm)</u>
SS-78-4023	255 x 245 x 50
SS-78-4024	255 x 245 x 70
SS-78-4025	255 x 245 x 100



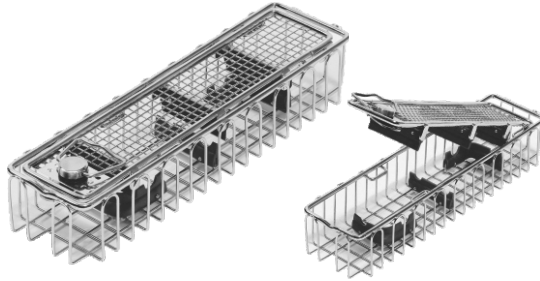
	<u>Dimension(mm)</u>
SS-78-4026	255 x 120 x 50
SS-78-4027	255 x 120 x 70

LIDs (optional)



	<u>Dimension(mm)</u>
SS-78-4028	255 x 120
SS-78-4029	255 x 245
SS-78-4030	250 x 240
SS-78-4031	540 x 255
SS-78-4032	485 x 255
SS-78-4033	405 x 255
SS-78-4034	480 x 370
SS-78-4035	480 x 250

Endoscopic Baskets



Dimension(mm)

SS-78-4036	290 x 80 x 52
SS-78-4037	460 x 80 x 52



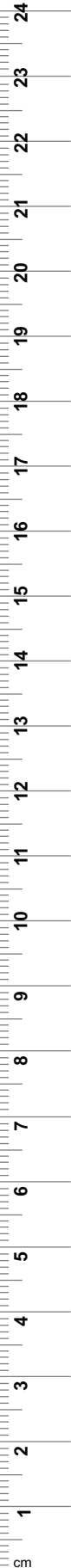
Dimension(mm)

SS-78-4038	670 x 80 x 52
SS-78-4039	700 x 80 x 52



Dimension(mm)

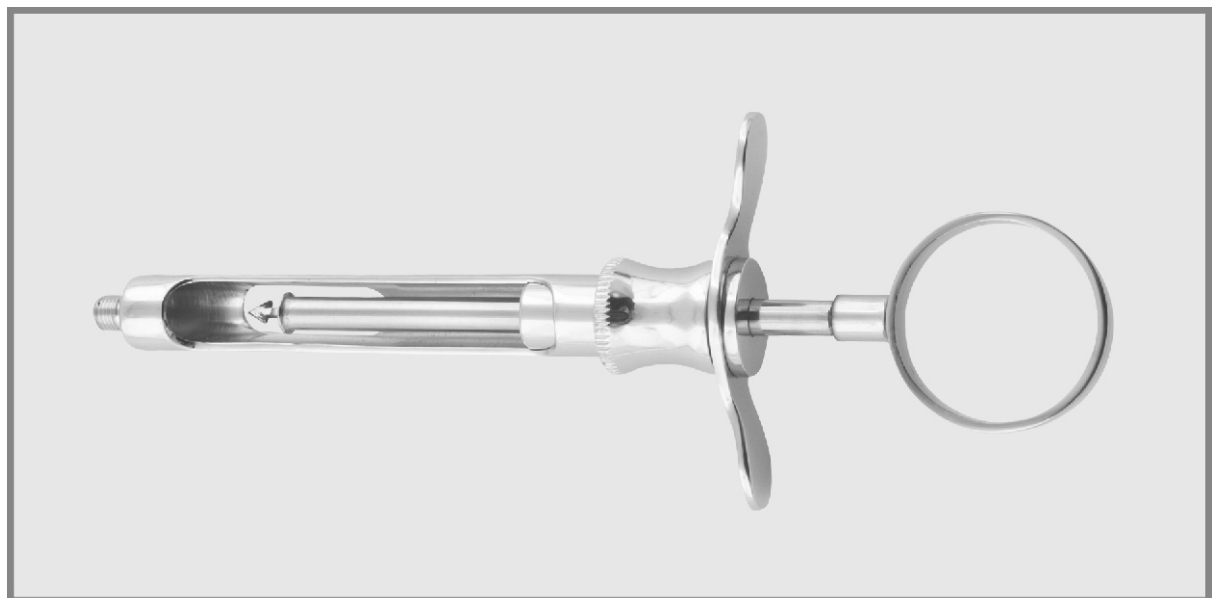
SS-78-4040	290 x 160 x 52
SS-78-4041	310 x 150 x 77
SS-78-4042	460 x 160 x 77
SS-78-4043	640 x 150 x 77
SS-78-4044	660 x 150 x 77
SS-78-4045	460 x 160 x 52
SS-78-4046	580 x 160 x 52



79

- EN** Cylinder cartridge syringe
- DE** Zylinder-Ampullenspritze
- ES** Seringue á ampoule cilindrique

Page 211 to 216





SS-79-4101
 Cylinder cartridge syringe
 1.8 cc, without aspiration
 metric thread / US Thread

SS-79-4103
 Cylinder cartridge syringe
 2.2 cc, without aspiration
 metric thread / US Thread



SS-79-4102
 Cylinder cartridge syringe
 1.8 cc, with aspiration
 metric thread / US Thread

SS-79-4104
 Cylinder cartridge syringe
 2.2 cc, with aspiration
 metric thread / US Thread

SS-79-4105
 Cylinder cartridge syringe
 1.8 cc, without aspiration with
 metric thread / US Thread

SS-79-4107
 Cylinder cartridge syringe
 2.2 cc, without aspiration with
 metric thread / US Thread

SS-79-4106
 Cylinder cartridge syringe
 1.8 cc, with aspiration with
 metric thread / US Thread

SS-79-4108
 Cylinder cartridge syringe
 2.2 cc, with aspiration with
 metric thread / US Thread



SS-79-4109

Cylinder cartridge syringe
1.8 cc, without aspiration
metric thread / US Thread

SS-79-4111

Cylinder cartridge syringe
2.2 cc, without aspiration
metric thread / US Thread

SS-79-4110

Cylinder cartridge syringe
1.8 cc, with aspiration
metric thread / US Thread

SS-79-4112

Cylinder cartridge syringe
2.2 cc, with aspiration
metric thread / US Thread



SS-79-4113

Cylinder Cartridge Syringe
1.8cc without Aspiration
metric thread / US Thread

SS-79-4115

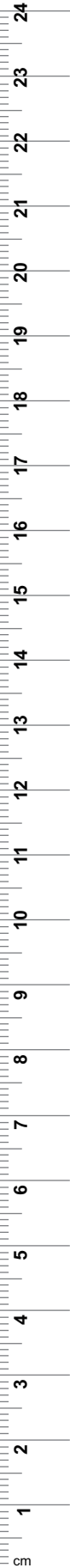
Cylinder Cartridge Syringe
2.2cc without Aspiration
metric thread / US Thread

SS-79-4114

Cylinder Cartridge Syringe
1.8cc with Aspiration
metric thread / US Thread

SS-79-4116

Cylinder Cartridge Syringe
2.2cc with Aspiration
metric thread / US Thread



- EN —● Cartridge syringes
- DE —● Ampullenspritzen
- ES —● Jeringas para cartucho apollas



SS-79-4117
Cylinder Cartridge Syringe
1.8cc without Aspiration
metric thread / US Thread
Plastic base & handle sand blast
finish steel rod.

SS-79-4119
Cylinder Cartridge Syringe
2.2cc without Aspiration
metric thread / US Thread
Plastic base & handle sand blast
finish steel rod.

SS-79-4118
Cylinder Cartridge Syringe
1.8cc with Aspiration
metric thread / US Thread
Plastic base & handle sand blast
finish steel rod.

SS-79-4120
Cylinder Cartridge Syringe
2.2cc with Aspiration
metric thread / US Thread
Plastic base & handle sand blast
finish steel rod.



SS-79-4121
Cylinder Cartridge Syringe
1.8cc without Aspiration
metric thread / US Thread

SS-79-4123
Cylinder Cartridge Syringe
2.2cc without Aspiration
metric thread / US Thread

SS-79-4122
Cylinder Cartridge Syringe
1.8cc with Aspiration
metric thread / US Thread

SS-79-4124
Cylinder Cartridge Syringe
2.2cc with Aspiration
metric thread / US Thread



SS-79-4125
Cylinder Cartridge Syringe
1.8cc without Aspiration
metric thread / US Thread

SS-79-4127
Cylinder Cartridge Syringe
2.2cc without Aspiration
metric thread / US Thread

SS-79-4126
Cylinder Cartridge Syringe
1.8cc with Aspiration
metric thread / US Thread

SS-79-4128
Cylinder Cartridge Syringe
2.2cc with Aspiration
metric thread / US Thread

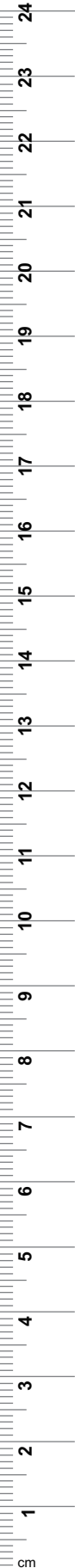


SS-79-4129
Cylinder Cartridge Syringe
1.8cc without Aspiration
metric thread / US Thread

SS-79-4131
Cylinder Cartridge Syringe
2.2cc without Aspiration
metric thread / US Thread

SS-79-4130
Cylinder Cartridge Syringe
1.8cc with Aspiration
metric thread / US Thread

SS-79-4132
Cylinder Cartridge Syringe
2.2cc with Aspiration
metric thread / US Thread



- EN —● Cartridge syringes
- DE —● Ampullenspritzen
- ES —● Jeringas para cartucho apollas



SS-79-4133
Cylinder Cartridge Syringe
1.8cc without Aspiration
metric thread / US Thread

SS-79-4135
Cylinder Cartridge Syringe
2.2cc without Aspiration
metric thread / US Thread

SS-79-4134
Cylinder Cartridge Syringe
1.8cc with Aspiration
metric thread / US Thread

SS-79-4136
Cylinder Cartridge Syringe
2.2cc with Aspiration
metric thread / US Thread



SS-79-4137
Aspirating Syringe
1.8cc with fix tip, S/S
metric thread / US Thread

SS-79-4138
Aspirating Syringe
2.2cc with fix tip, S/S
metric thread / US Thread

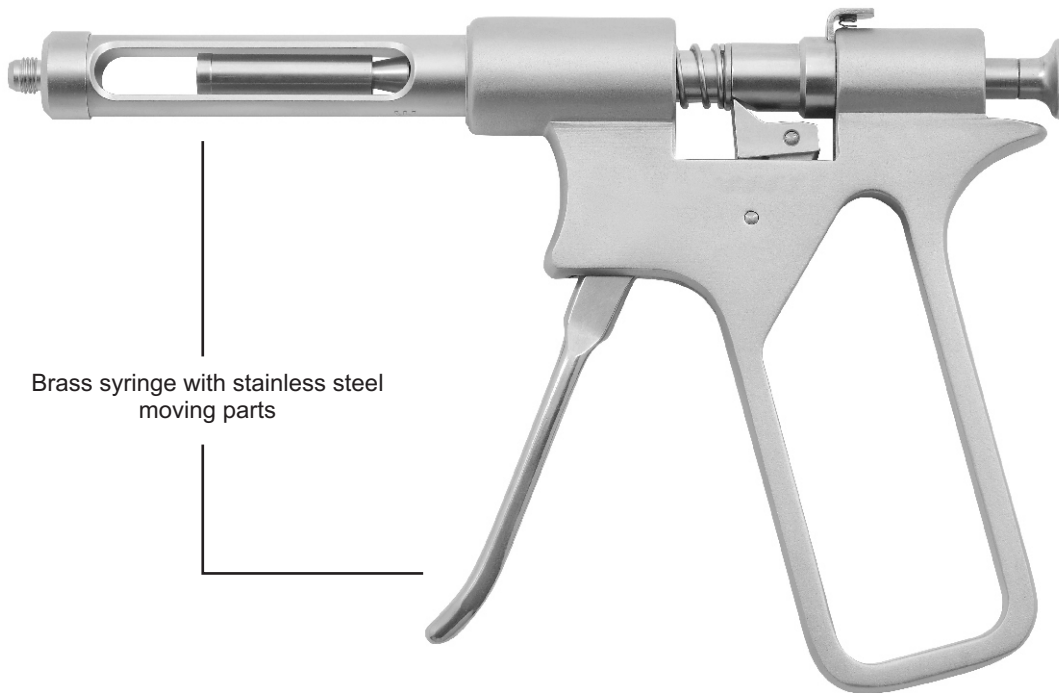
Intra-Ligamentale Syringes



SS-79-4139

1.8 cc metric thread / US Thread

2.2 cc metric thread / US Thread

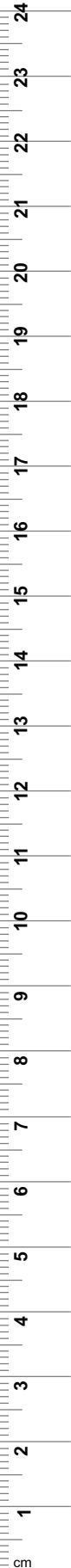


Brass syringe with stainless steel moving parts

SS-79-4140

1.8 cc metric thread / US Thread

2.2 cc metric thread / US Thread



80

EN

Impression Trays

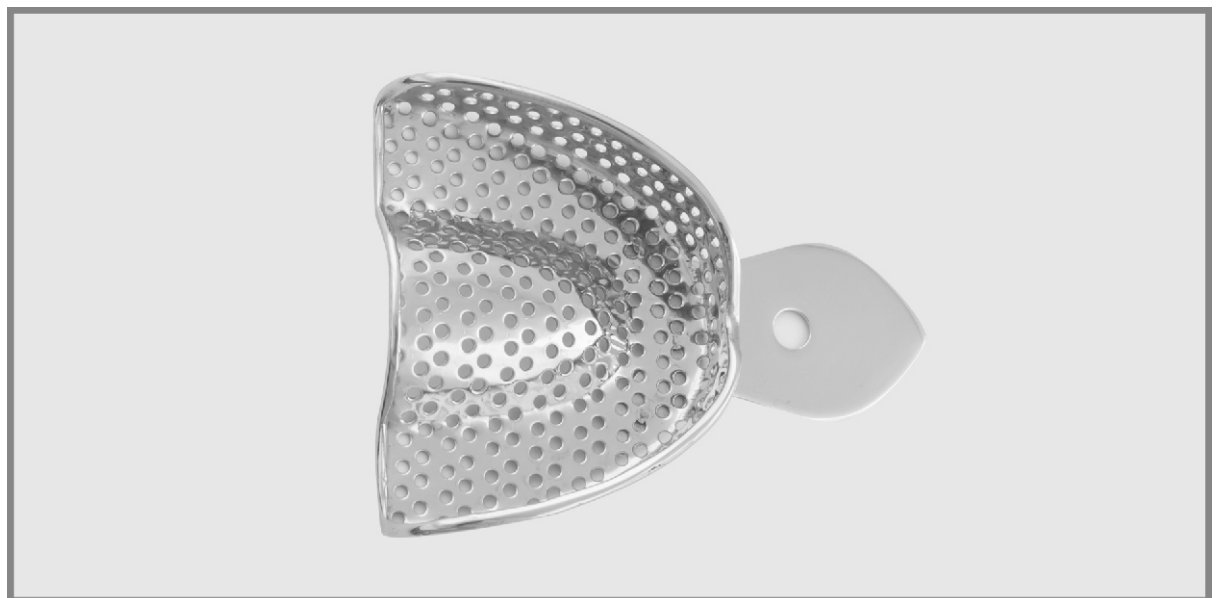
DE

Abdrucklöffel

ES

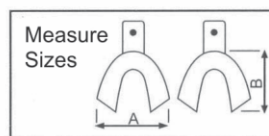
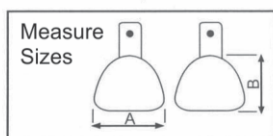
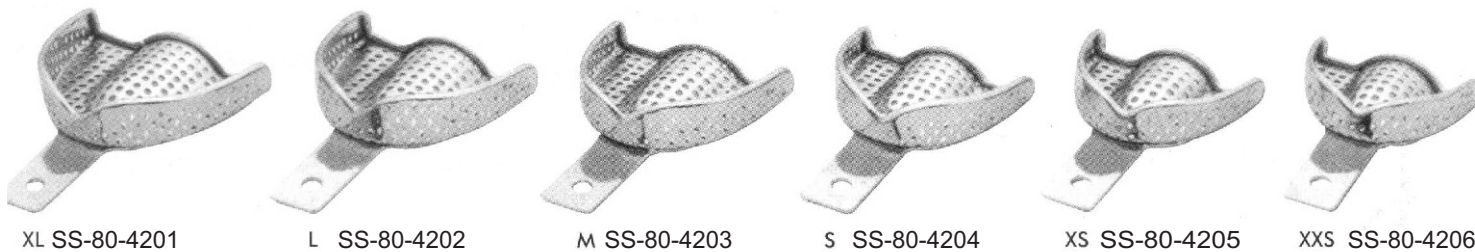
Porte empreintes

Page 217 to 228



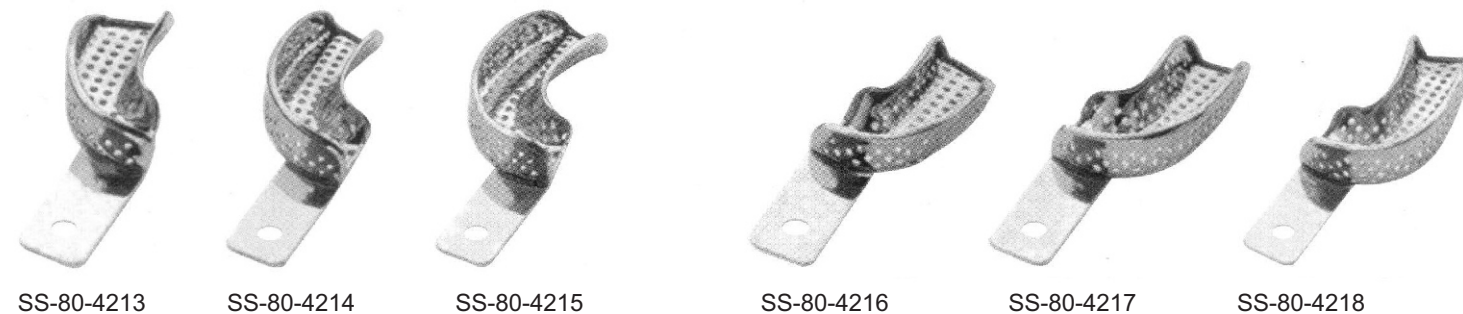
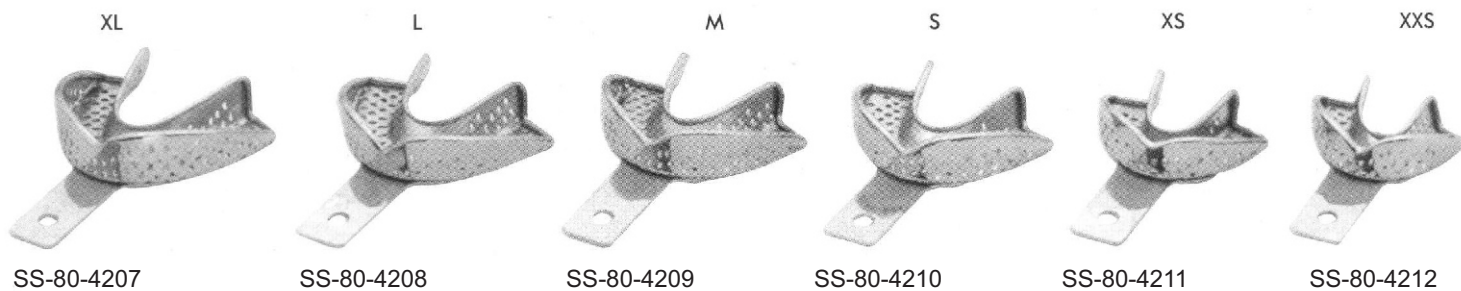
EN — Impression Trays Perforated with Rim Lock
 DE — Abdrucklöffel perforiert mit Rim Lock
 ES — Bandejas de impresión perforadas con borde de bloqueo

IMPRESSION TRAYS

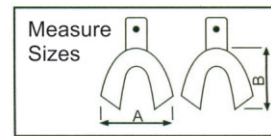
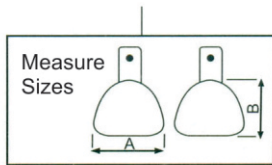
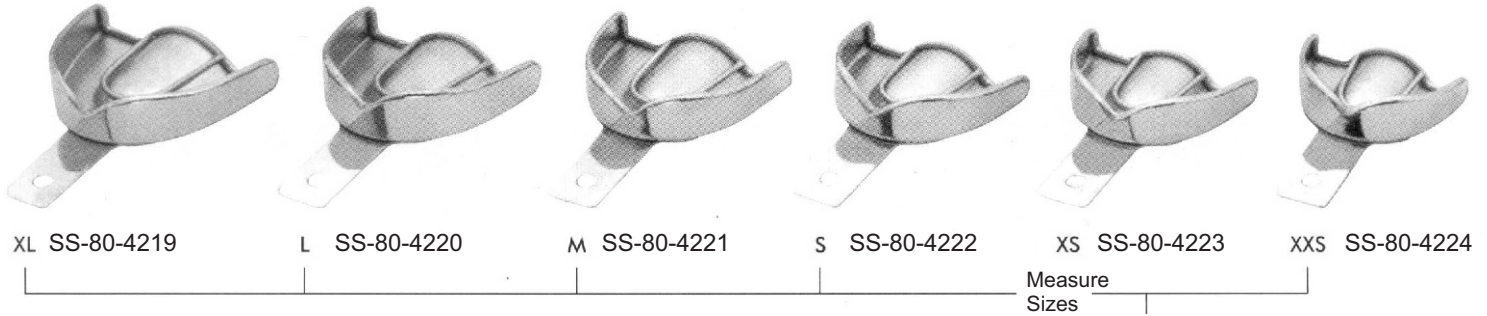


Upper		A (left-right)	B (top-bottom)
80-4201	XL	81 mm	63 mm
80-4202	L	73 mm	58 mm
80-4203	M	71 mm	52 mm
80-4204	S	67 mm	53 mm
80-4205	XS	65 mm	51 mm
80-4206	XXS	61 mm	50 mm

Lower		A (left-right)	B (top-bottom)
80-4207	XL	78 mm	63 mm
80-4208	L	74 mm	62 mm
80-4209	M	72 mm	59 mm
80-4210	S	70 mm	57 mm
80-4211	XS	69 mm	55 mm
80-4212	XXS	59 mm	50 mm

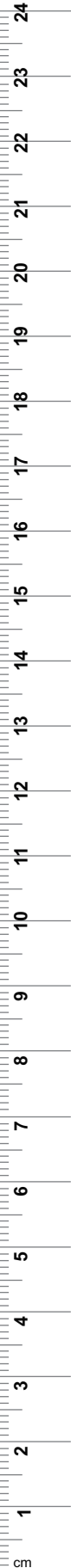
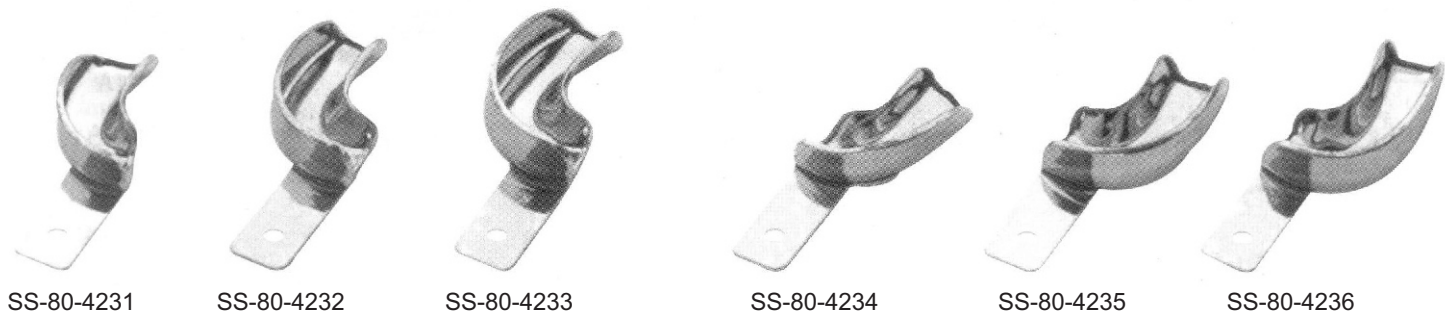
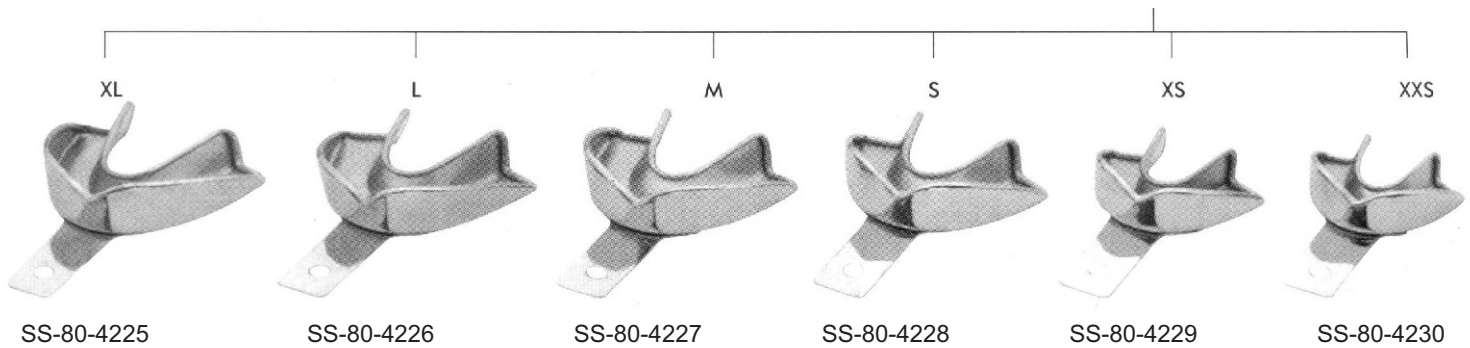


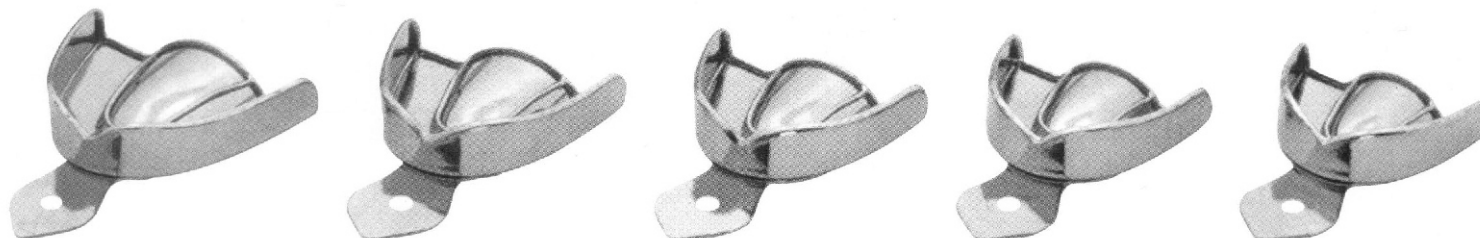
IMPRESSION TRAYS



Upper		A (left-right)	B (top-bottom)
81-4219	XL	81 mm	63 mm
81-4220	L	73 mm	58 mm
81-4221	M	71 mm	52 mm
81-4222	S	67 mm	53 mm
81-4223	XS	65 mm	51 mm
81-4224	XXS	61 mm	50 mm

Lower		A (left-right)	B (top-bottom)
81-4225	XL	78 mm	63 mm
81-4226	L	74 mm	62 mm
81-4227	M	72 mm	59 mm
81-4228	S	70 mm	57 mm
81-4229	XS	69 mm	55 mm
81-4201	XXS	59 mm	50 mm





SS-80-4237

SS-80-4238

SS-80-4239

SS-80-4240

SS-80-4241

XL

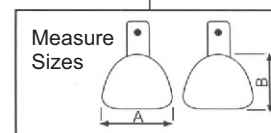
L

M

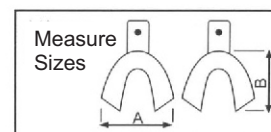
S

XS

Upper		A (left-right)	B (top-bottom)
SS-80-4237	XL	81 mm	63 mm
SS-80-4238	L	73 mm	58 mm
SS-80-4239	M	71 mm	52 mm
SS-80-4240	S	67 mm	53 mm
SS-80-4241	XS	65 mm	51 mm



Lower		A (left-right)	B (top-bottom)
SS-80-4242	XL	78 mm	63 mm
SS-80-4243	L	74 mm	62 mm
SS-80-4244	M	72 mm	59 mm
SS-80-4245	S	70 mm	57 mm
SS-80-4246	XS	69 mm	55 mm



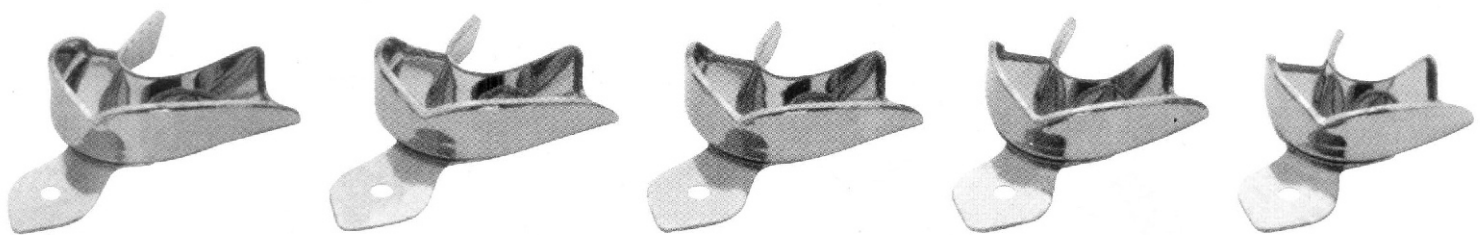
XL

L

M

S

XS



SS-80-4242

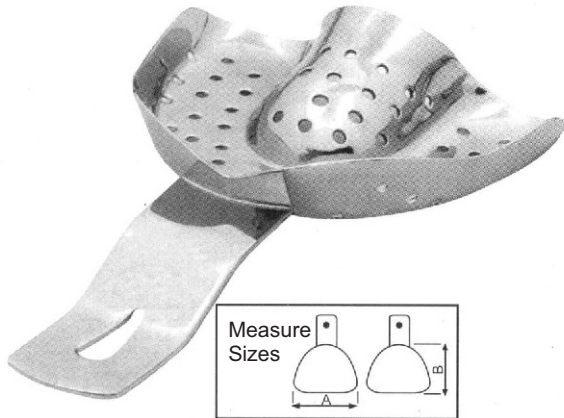
SS-80-4243

SS-80-4244

SS-80-4245

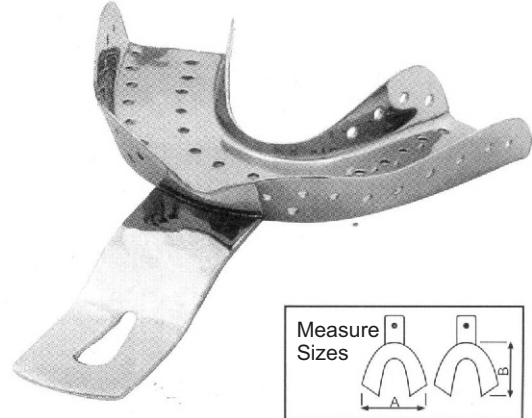
SS-80-4246

IMPRESSION TRAYS



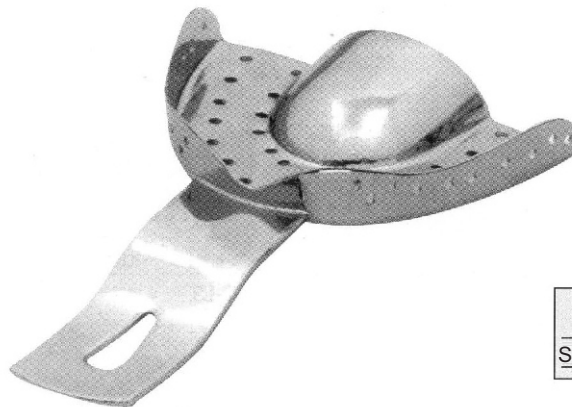
For Toothed Upper Jaws
 (Fig. 0 for children)

	A	B
	mm.	mm.
SS-80-4247 0	59	52
SS-80-4248 1	66	52
SS-80-4249 2	71	62
SS-80-4250 3	71	64
SS-80-4251 4	80	70



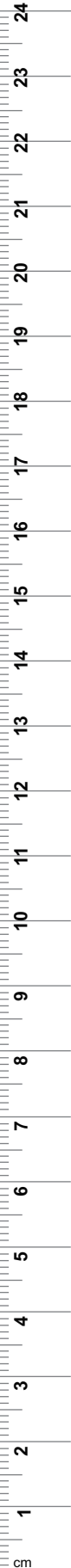
For Toothed Lower Jaws
 (Fig. 0 for children)

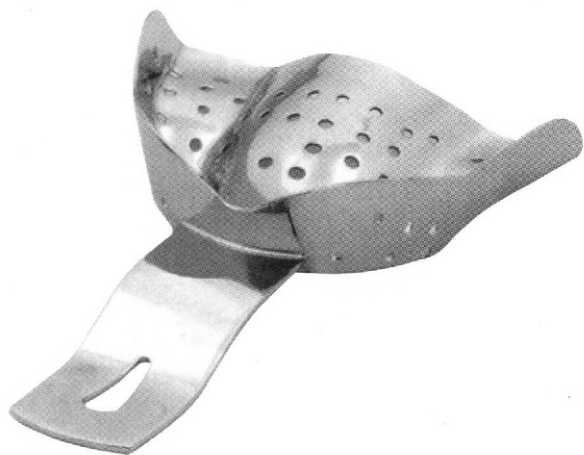
	A	B
	mm.	mm.
SS-80-4252 0	65	46
SS-80-4253 1	67	50
SS-80-4254 2	76	54
SS-80-4255 3	79	56
SS-80-4256 4	79	61



For Narrow Toothed Upper Jaws

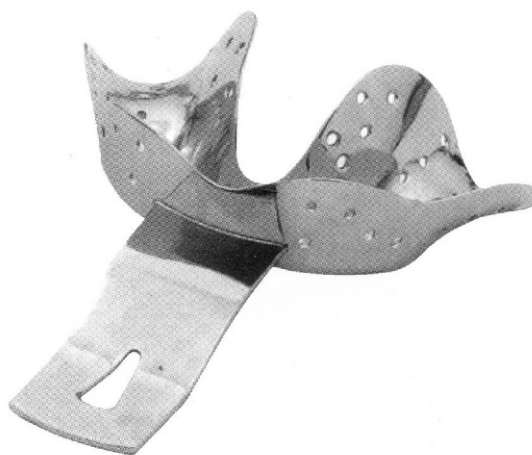
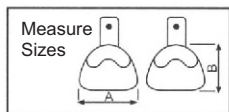
	A	B
	mm.	mm.
SS-80-4257 2	70	54





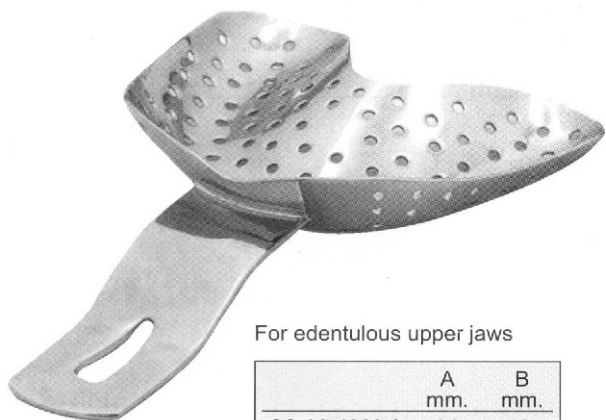
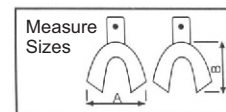
For partially toothed upper jaws

	A mm.	B mm.
SS-80-4258 1	62	50
SS-80-4259 2	70	56



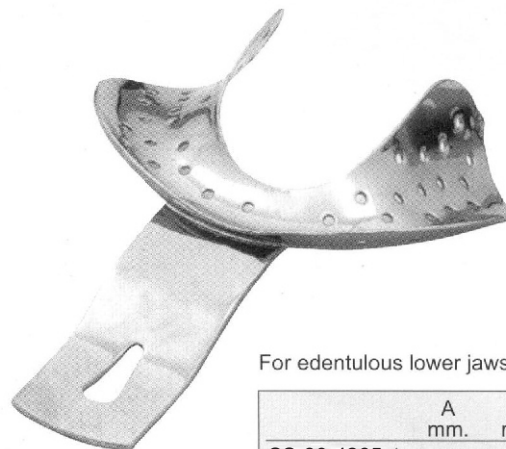
For partially toothed lower jaws

	A mm.	B mm.
SS-80-4260 1	70	55
SS-80-4261 2	78	59



For edentulous upper jaws

	A mm.	B mm.
SS-80-4262 1	64	46
SS-80-4263 2	68	53
SS-80-4264 3	79	61



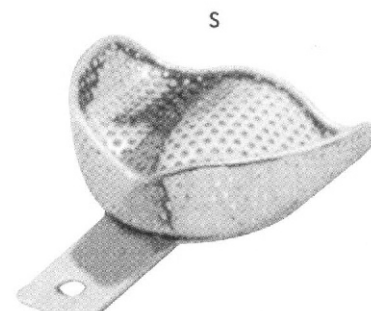
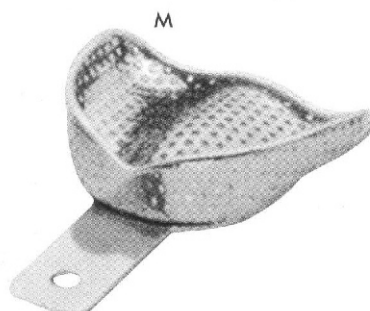
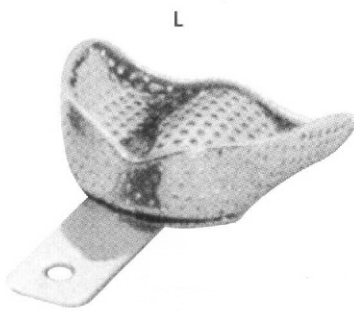
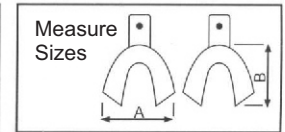
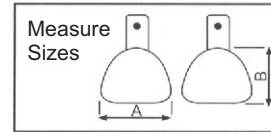
For edentulous lower jaws

	A mm.	B mm.
SS-80-4265 1	70	48
SS-80-4266 2	70	53
SS-80-4267 3	72	57

IMPRESSION TRAYS



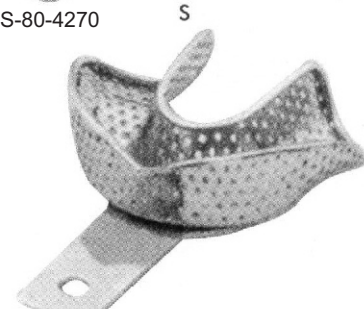
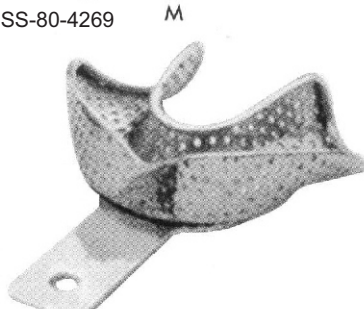
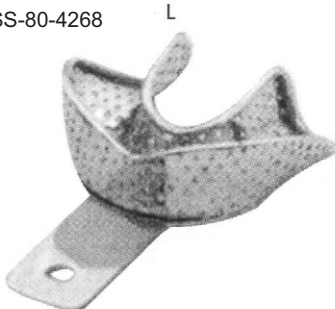
Solid stainless steel anterior depressed impression trays with retention rim.



SS-80-4268

SS-80-4269

SS-80-4270



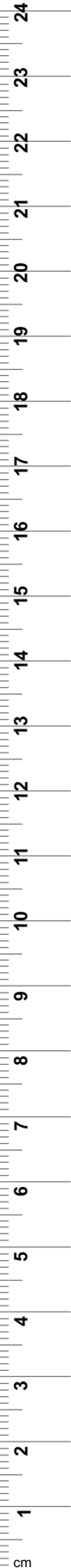
SS-80-4271

SS-80-4272

SS-80-4273

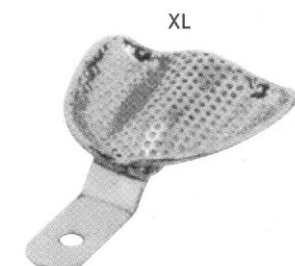
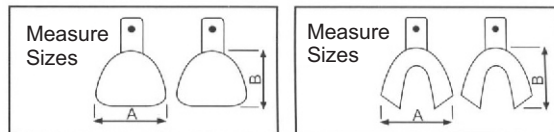
		A mm.	B mm.
SS-80-4268	L	81	67
SS-80-4269	M	71	64
SS-80-4270	S	70	57

		A mm.	B mm.
SS-80-4271	L	81	60
SS-80-4272	M	79	57
SS-80-4273	S	76	54

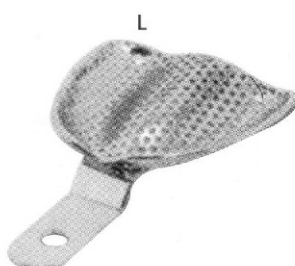




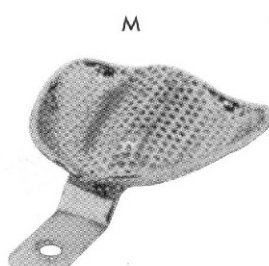
Solid total denture stainless steel impression trays with rim.



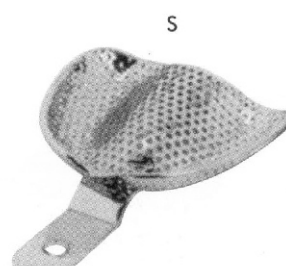
SS-80-4274



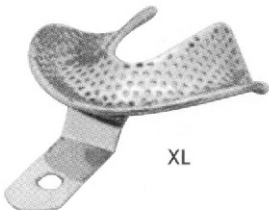
SS-80-4275



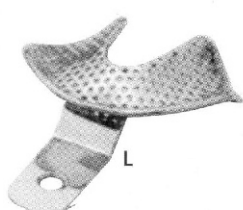
SS-80-4276



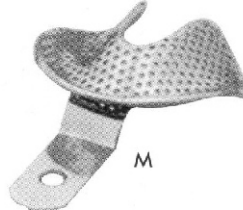
SS-80-4277



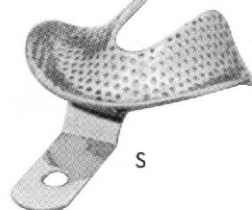
SS-80-4278



SS-80-4279



SS-80-4280

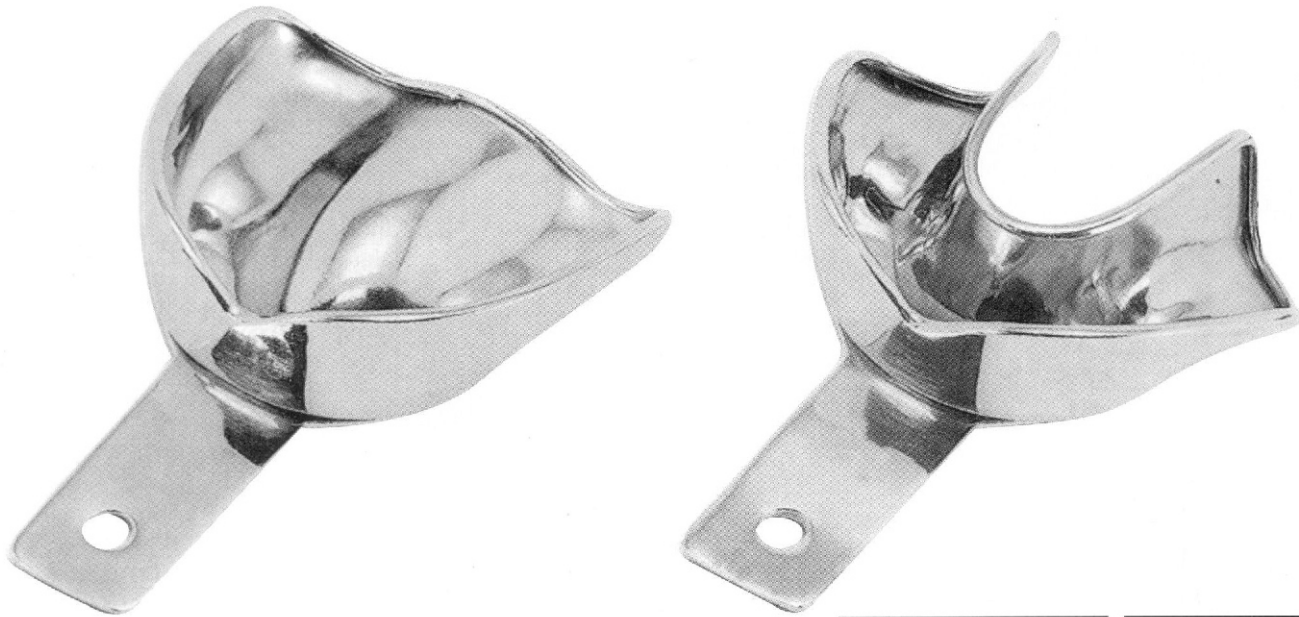


SS-80-4281

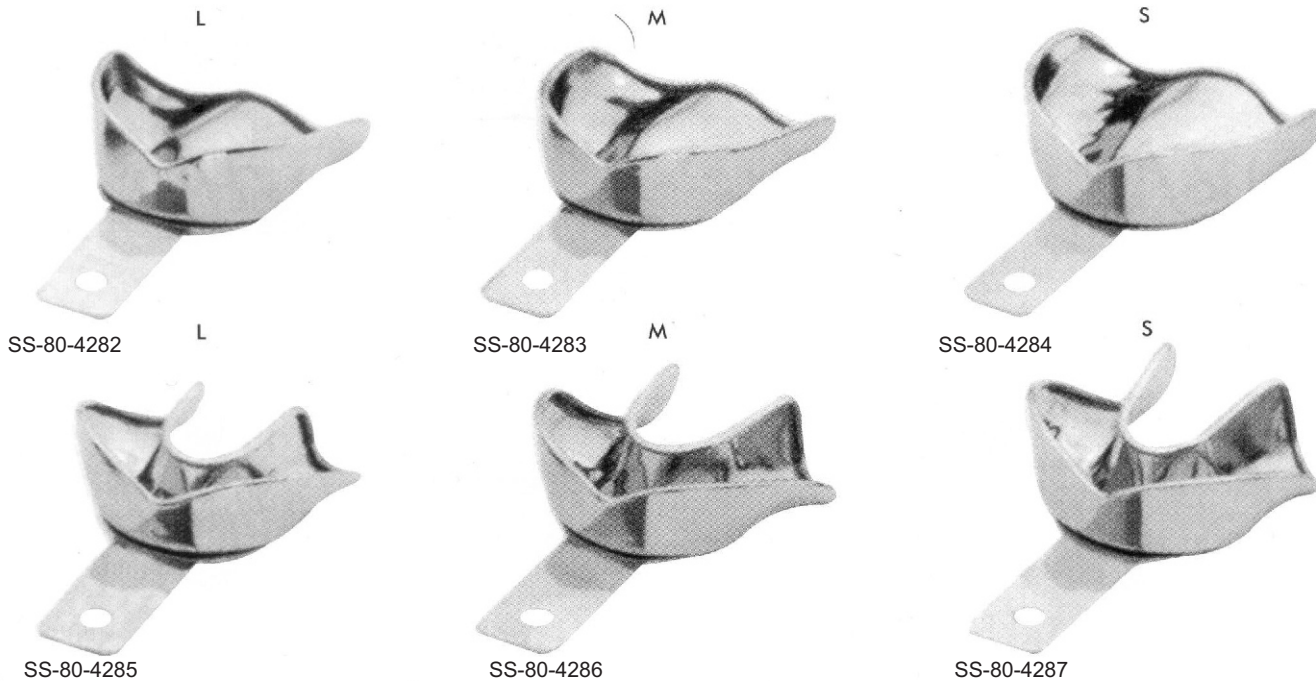
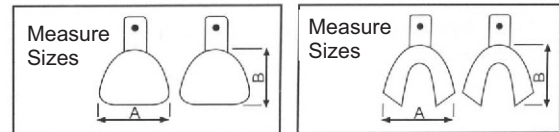
	A mm.	B mm.
SS-80-4274 XL	79	70
SS-80-4275 L	76	67
SS-80-4276 M	70	64
SS-80-4277 S	73	60

	A mm.	B mm.
SS-80-4278 XL	86	64
SS-80-4279 L	70	64
SS-80-4280 M	73	60
SS-80-4281 S	70	57

IMPRESSION TRAYS

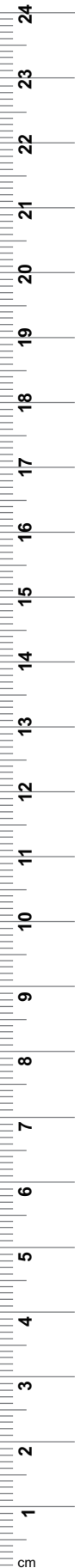


Solid stainless steel anterior depressed impression trays with retention rim.



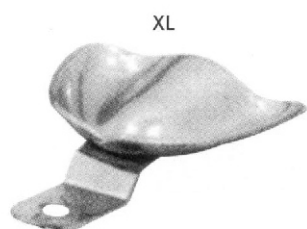
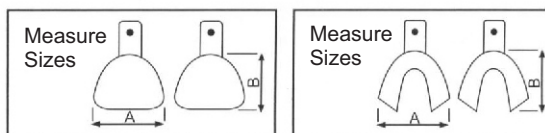
	A mm.	B mm.
SS-80-4282 L	81	67
SS-80-4283 M	71	64
SS-80-4284 S	70	57

	A mm.	B mm.
SS-80-4285 L	81	60
SS-80-4286 M	79	57
SS-80-4287 S	76	54



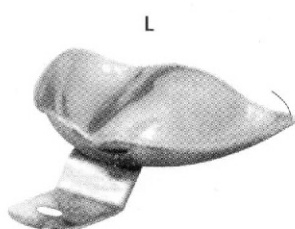


Solid total denture stainless steel impression trays with rim.



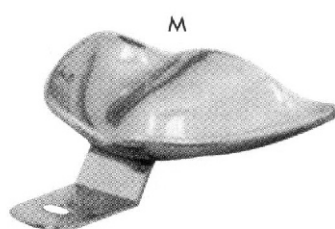
XL

SS-80-4288



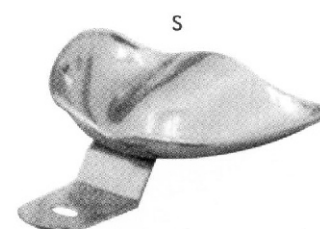
L

SS-80-4289



M

SS-80-4290



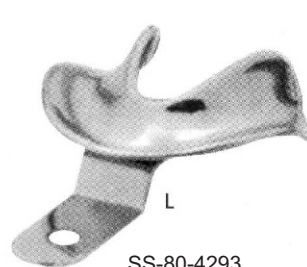
S

SS-80-4291



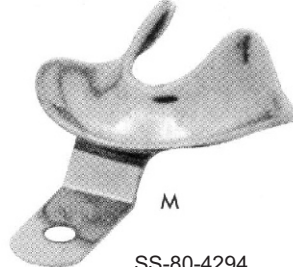
XL

SS-80-4292



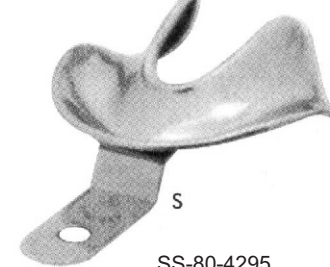
L

SS-80-4293



M

SS-80-4294



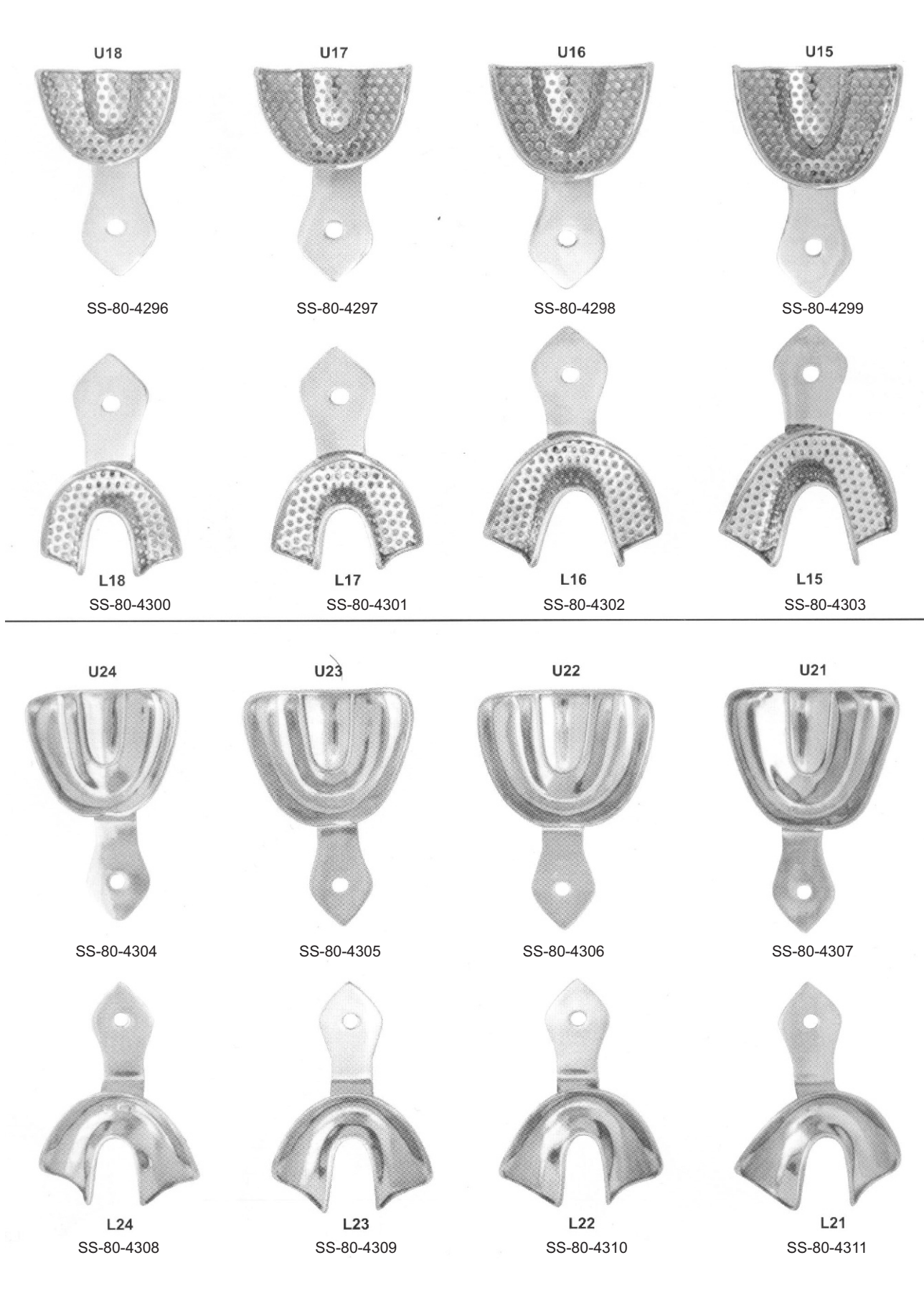
S

SS-80-4295

	A mm.	B mm.
SS-80-4288XL	79	70
SS-80-4289 L	76	67
SS-80-4290M	70	64
SS-80-4291 S	73	60

	A mm.	B mm.
SS-80-4292 XL	86	64
SS-80-4293 L	70	64
SS-80-4294 M	73	60
SS-80-4295 S	70	57

Impression Trays — EN
 Knochenfeilen — DE
 Limes à os — ES



U18



SS-80-4296

U17



SS-80-4297

U16



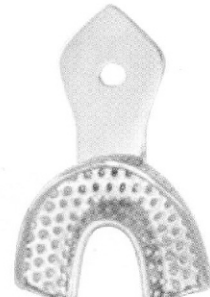
SS-80-4298

U15



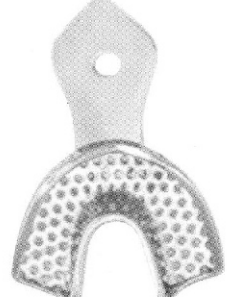
SS-80-4299

L18



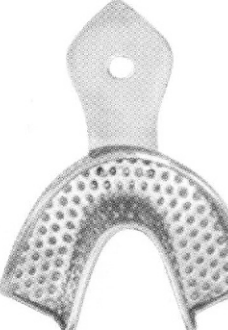
SS-80-4300

L17



SS-80-4301

L16



SS-80-4302

L15



SS-80-4303

U24



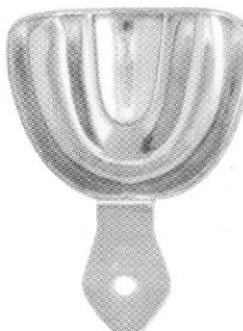
SS-80-4304

U23



SS-80-4305

U22



SS-80-4306

U21



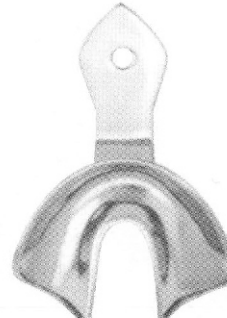
SS-80-4307

L24



SS-80-4308

L23



SS-80-4309

L22

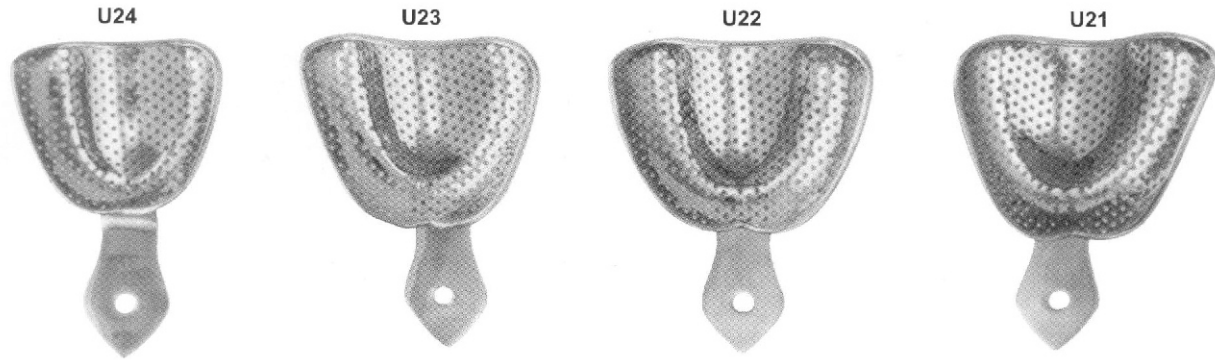


SS-80-4310

L21



SS-80-4311



SS-80-4312

SS-80-4313

SS-80-4314

SS-80-4315



SS-80-4316

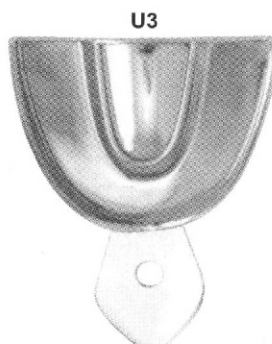
SS-80-4317

SS-80-4318

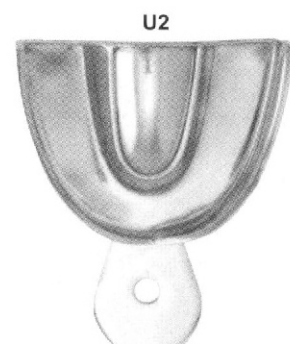
SS-80-4319



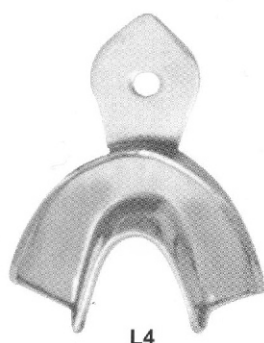
SS-80-4320



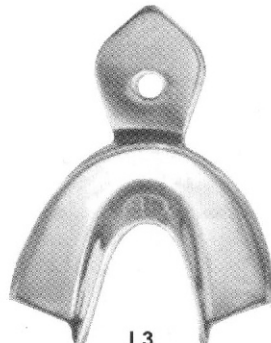
SS-80-4321



SS-80-4322



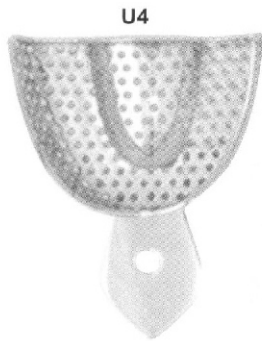
SS-80-4323



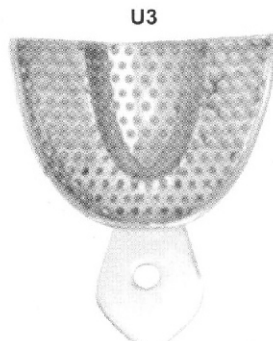
SS-80-4324



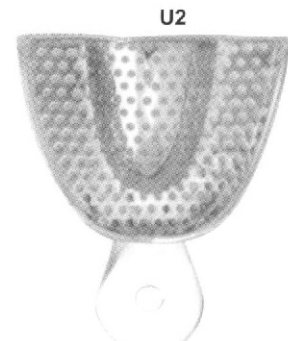
SS-80-4325



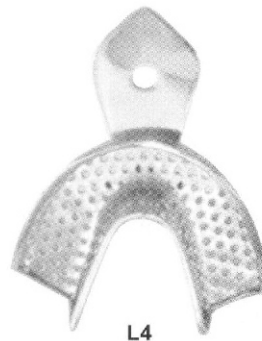
SS-80-4326



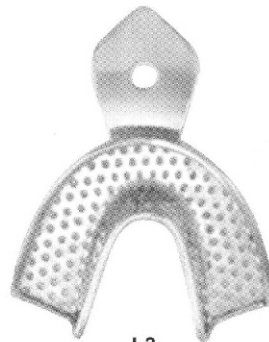
SS-80-4327



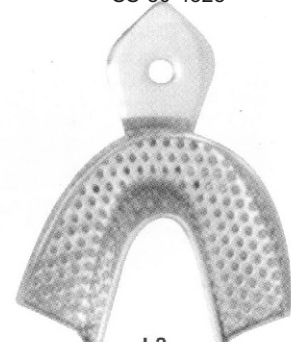
SS-80-4328



SS-80-4329



SS-80-4330



SS-80-4331



SS-80-4332



SS-80-4333



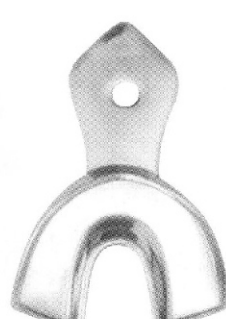
SS-80-4334



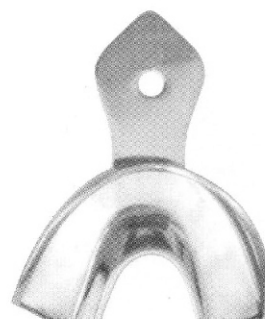
SS-80-4335



SS-80-4336



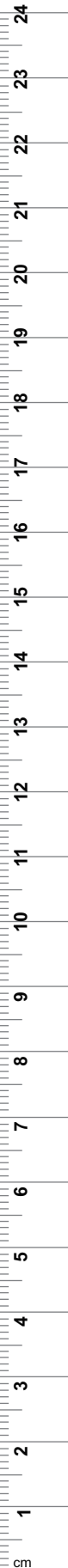
SS-80-4337



SS-80-4338



SS-80-4339

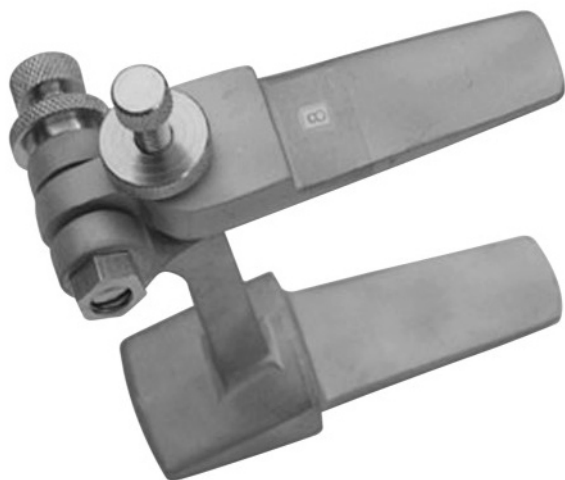


81

- EN** Articulators
- DE** Artikulatoren
- ES** Articuladores

Page 229 to 230





SS-81-4301



SS-81-4302



SS-81-4303



SS-81-4304

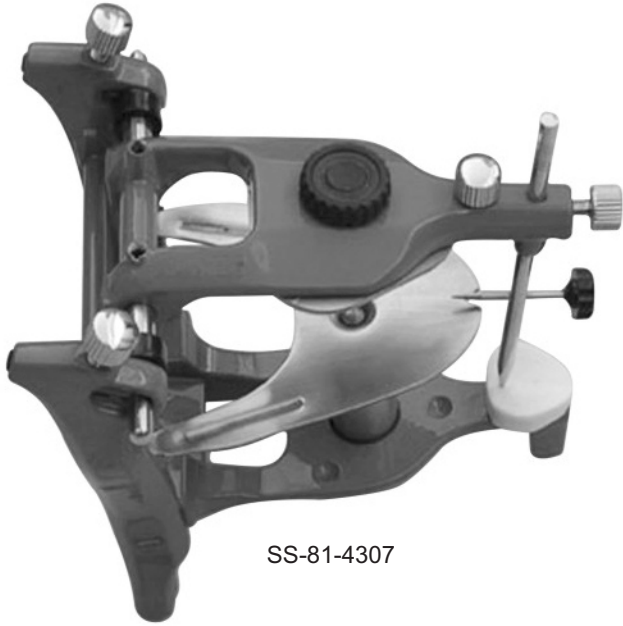


SS-81-4306



SS-81-4305





SS-81-4308



SS-81-4309



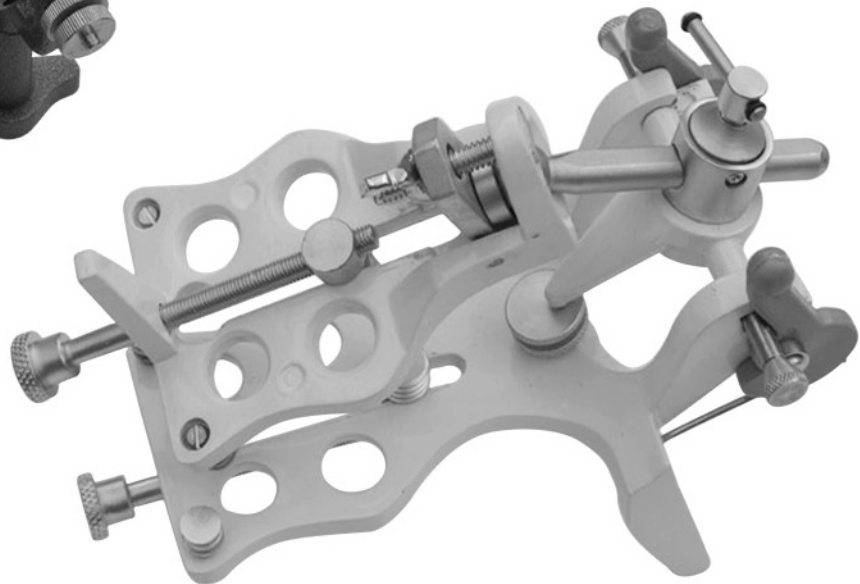
SS-81-4310



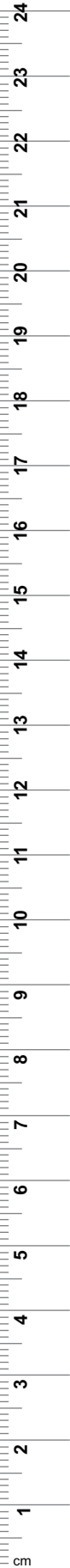
SS-81-4311



SS-81-4312



SS-81-4313



82

EN	Holloware
DE	Holloware
ES	holloware

Page 231 to 234





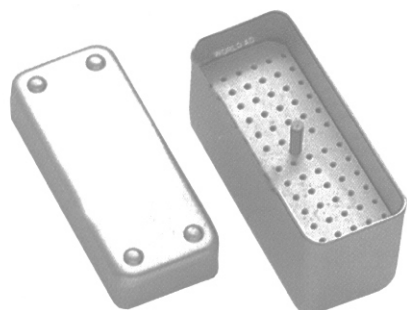
Needle Case Round with Cover
 SS-82-4401 65x15mm



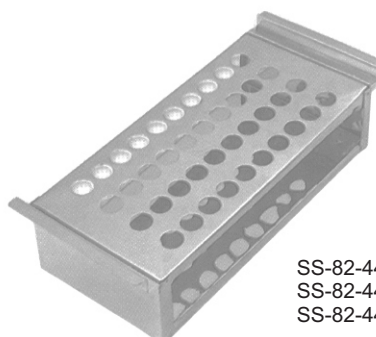
Needle Case Round
 SS-82-4402 80x20mm



Needle Case Rectangle
 SS-82-4403 70x70x10mm



Endodontic Box
 SS-82-4404
 100x40x50mm



Tube Rack

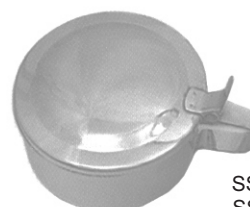
SS-82-4405 6.35x15.25x5cm for 12 tubes
 SS-82-4406 6.35x17.75x7.5cm for 27 tubes
 SS-82-4407 7.50x17.75x6.35cm for 36 tubes



Sprit Lamp
 SS-82-4408
 Standard Size



Sprit Lamp
 SS-82-4409
 Standard Size



Sputum Cup

SS-82-4410 75x80mm
 SS-82-4411 100x50mm
 SS-82-4412 100x80mm



Dressing Jar

SS-82-4413	80x60mm	SS-82-4420
SS-82-4414	80x80mm	SS-82-4421
SS-82-4415	100x100mm	SS-82-4423
SS-82-4416	120x120mm	SS-82-4424
SS-82-4417	150x150mm	SS-82-4425
SS-82-4418	180x180mm	SS-82-4426
SS-82-4419	200x200mm	SS-82-4427



Dressing Jar



Fennle

SS-82-4428 100mm Ø
 SS-82-4429 120mm Ø
 SS-82-4430 150mm Ø
 SS-82-4431 200mm Ø



Cotton Holder
 SS-82-4432



Cotton Holder
 SS-82-4433





Forceps Jar

- SS-82-4434 30x90mm
- SS-82-4435 50x125mm
- SS-82-4436 50x170mm
- SS-82-4437 50x200mm
- SS-82-4438 40x230mm
- SS-82-4439 70x110mm
- SS-82-4440 80x150mm
- SS-82-4441 100x200mm
- SS-82-4442 150x30mm



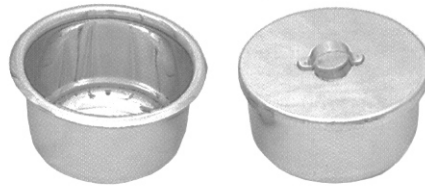
Medicine Cup

- SS-82-4461 50ml
- SS-82-4462 60ml
- SS-82-4463 70ml



Kick Bucket with Trolley

- 30-6819-01
- 390x280x180mm



Gallipot

- | | |
|------------------|------------------|
| SS-82-4443 01 oz | SS-82-4450 09 oz |
| SS-82-4444 02 oz | SS-82-4451 10 oz |
| SS-82-4445 03 oz | SS-82-4452 11 oz |
| SS-82-4446 04 oz | SS-82-4453 12 oz |
| SS-82-4447 05 oz | SS-82-4454 13 oz |
| SS-82-4448 06 oz | SS-82-4455 14 oz |
| SS-82-4448 07 oz | SS-82-4456 15 oz |
| SS-82-4449 08 oz | SS-82-4457 16 oz |



Lotion Bowl without spout

- | | |
|---------------------|----------------------|
| SS-82-4464 40x19mm | SS-82-4471 150x65mm |
| SS-82-4465 50x25mm | SS-82-4472 180x85mm |
| SS-82-4466 60x30mm | SS-82-4473 200x100mm |
| SS-82-4467 80x40mm | SS-82-4474 250x120mm |
| SS-82-4468 100x50mm | SS-82-4475-12 300mm |
| SS-82-4469 120x60mm | SS-82-4476-13 350mm |
| SS-82-4470 140x60mm | SS-82-4477-14 400mm |



Sponge Bowl

- SS-82-4458 12 cm
- SS-82-4459 15 cm
- SS-82-4460 20 cm



Wash Basin

- SS-82-4478 300x80mm
- SS-82-4479 320x85mm
- SS-82-4480 330x90mm
- SS-82-4481 350x110mm
- SS-82-4482 400x115mm



Kidney Tray

- SS-82-4486 12cm
- SS-82-4487 15cm
- SS-82-4488 18cm
- SS-82-4489 20cm
- SS-82-4490 25cm
- SS-82-4491 28cm
- SS-82-4492 30cm



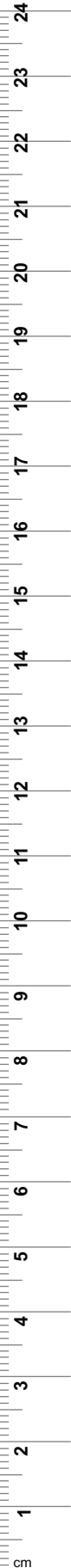
Kidney Tray Shallow

- SS-82-4483 17cm
- SS-82-4484 22cm
- SS-82-4485 24cm



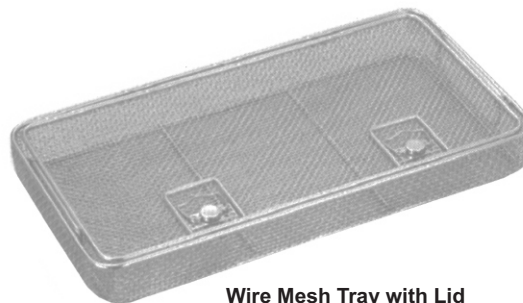
Kidney Tray (with cover)

- SS-82-4493 15cm
- SS-82-4494 20cm
- SS-82-4495 25cm
- SS-82-4496 30cm





Wire Mesh Tray
 SS-82-4497 240x250x5mm
 SS-82-4498 480x250x5mm
 SS-82-4499 550x250x5mm
 SS-82-4500 240x250x7mm
 SS-82-4501 480x250x7mm
 SS-82-4502 240x250x10mm
 SS-82-4503 480x250x10mm



Wire Mesh Tray with Lid
 SS-82-4504 240x250x5mm
 SS-82-4505 480x250x5mm
 SS-82-4506 550x250x5mm
 SS-82-4507 240x250x7mm
 SS-82-4508 480x250x7mm
 SS-82-4509 240x250x10mm
 SS-82-4510 480x250x10mm



Perforated Tray
 SS-82-4511 200x100x40mm
 SS-82-4512 250x120x50mm
 SS-82-4513 300x150x50mm
 SS-82-4514 350x170x50mm
 SS-82-4515 400x200x50mm



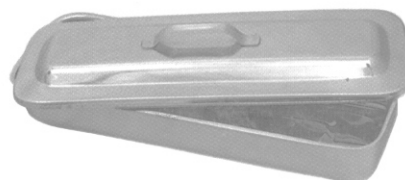
Instruments Tray without Lid
 SS-82-4516 100x150x25mm
 SS-82-4517 150x200x40mm
 SS-82-4518 200x250x45mm
 SS-82-4519 250x300x50mm
 SS-82-4520 300x350x50mm
 SS-82-4521 150x300x50mm
 SS-82-4522 200x300x50mm
 SS-82-4523 230x150x50mm



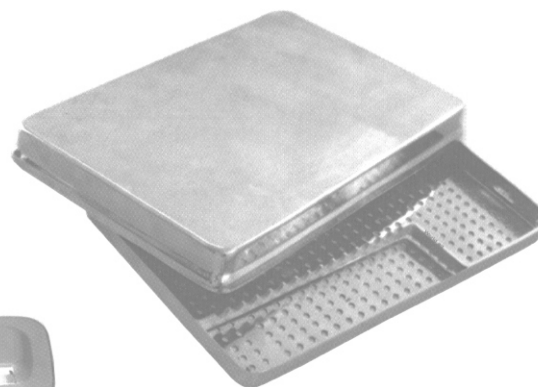
Instruments Tray with Lid
 SS-82-4524 100x150x25mm
 SS-82-4525 150x200x40mm
 SS-82-4526 200x250x45mm
 SS-82-4527 250x300x50mm
 SS-82-4528 300x350x50mm
 SS-82-4529 150x300x50mm
 SS-82-4530 200x300x50mm
 SS-82-4531 230x150x50mm



Burr Tray
 SS-82-4532
 190x100x20mm



Cathetes Tray with Lid
 SS-82-4533 300x80x40mm
 SS-82-4534 350x90x45mm
 SS-82-4535 400x100x50mm



Scaler Tray with cover
 SS-82-4536
 200x100x16mm



**Instruments Box
with Hooks**

- SS-82-4537 170x70x30mm
- SS-82-4538 180x80x40mm
- SS-82-4539 200x100x40mm
- SS-82-4540 230x120x50mm
- SS-82-4541 250x125x50mm
- SS-82-4542 300x150x50mm
- SS-82-4543 350x170x50mm
- SS-82-4544 400x200x90mm
- SS-82-4545 500x200x120mm



Instruments Box

- SS-82-4546 170x70x30mm
- SS-82-4547 180x80x40mm
- SS-82-4548 200x100x40mm
- SS-82-4549 230x120x50mm
- SS-82-4550 250x125x50mm
- SS-82-4551 300x150x50mm
- SS-82-4552 350x170x50mm
- SS-82-4553 400x200x90mm
- SS-82-4554 500x200x120mm



**Instruments Box
Perforated**

- SS-82-4555 200x100x40mm
- SS-82-4556 250x150x40mm
- SS-82-4557 300x150x40mm



Electric Sterilizer

- SS-82-4558 200x100x120mm
- SS-82-4559 250x120x140mm
- SS-82-4560 300x150x150mm
- SS-82-4561 350x170x170mm
- SS-82-4562 400x200x180mm
- SS-82-4563 450x230x190mm



Non Electric Sterilizer

- SS-82-4564 200x100x65mm
- SS-82-4565 250x125x65mm
- SS-82-4566 300x150x100mm
- SS-82-4567 350x170x65mm
- SS-82-4568 400x200x100mm

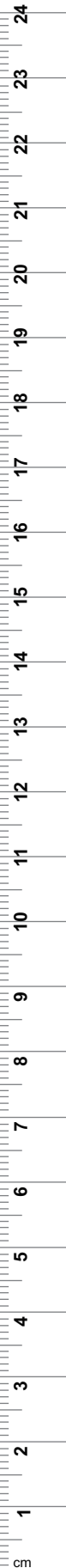


Electric Sterilizer
SS-82-4569
280x125x65mm

- SS-82-4570 125x80mm
- SS-82-4571 125x120mm
- SS-82-4572 150x100mm
- SS-82-4573 150x150mm
- SS-82-4574 180x180mm
- SS-82-4575 190x140mm
- SS-82-4576 190x190mm
- SS-82-4577 200x200mm
- SS-82-4578 240x120mm
- SS-82-4579 240x240mm
- SS-82-4580 290x140mm
- SS-82-4581 290x240mm
- SS-82-4582 290x290mm
- SS-82-4583 340x160mm
- SS-82-4584 340x340mm
- SS-82-4585 390x150mm
- SS-82-4586 390x200mm
- SS-82-4587 390x290mm



Sterilizer Drum





Add: Soulach Park, Kashmir Road,
Pacca Garha, Sialkot - 51310,
Pakistan.Tel: 0092-52-4352070
Whatsapp: 0092-344-6481581
Email: info@surgi-skill.com
Email: surgiskill2026@gmail.com