



**SURGICAL INSTRUMENTS
CATALOGUE**

www.surgi-skill.com



For over 30 years SURGI SKILL has been devoted to providing its customers with the highest quality Electrosurgical, Surgical, Dental, Beauty, Podiatry, Veterinary and Single Use Instruments.

SURGI SKILL is committed to provide you with the highest quality instruments. We are the original equipment manufacturer (OEM) for all above mention instruments.

Our production depth covers thousands of instruments ranging from the typical instruments use in clinic to sophisticated instruments required during surgeries. We deem, however, pertinent to submit further that the range and scope of our production activities is not limited to our production literature. We can produce instruments even if not depicted in our online catalogues. We receive samples, photos or references from the world-renowned companies catalogues.

QUALITY/ INNOVATION

At SURGI SKILL the quality is set in motion through motivated specifications planning by trained technical persons. The computer added design and imaging provide visual instruments a set configuration. This simplifies each aspect of instruments manufacturing.

QUALITY CERTIFICATIONS:

We are ISO 9001:2015, ISO 13485:2016, CE MARK, CGMP approved.

COMMITMENT:

Our commitment is to meet the changing needs of healthcare systems and to lead the industry by providing quality surgical instruments and dental instruments at competitive price.

We understand the diverse needs of our customers and know that quality along with delivery time are the most important and common requirements of our customers from both segments. This Realization allows us to serve our customers in the most efficient and cost effective manners.

Wish you all the Best.

SURGI SKILL Team

PODIATRY INSTRUMENTS

Nail Clippers	01 - 02
Heavy Duty Nail Clippers	03
Nail Clippers with T.C	03
Double Action Nail Clippers	04 - 05
Ingrown Nail Clippers	06 - 08
Tissue Nippers	09 - 10
Nail Clipper G/Handle	11
Ingrown Nail Clippers G/Handle	11 - 14
Scalpel Handle	15
Probes	15
Black Nail Files Double Ended	15 - 16
Black Nail Files Single Ended	16
Foot Rasps	17
Diamond Deb Foot Dresser	18
Foreign Body Curettes	18
Volkman Nail Curettes	19 - 20
Dura & Skin Retractor	20 - 21
Nail Scope Curettes	21
Nail Spatulas	21 - 22
Nail Carvers	22
Nail Probes	22 - 23
Professional Surgical Scissors	24 - 26
G.P Surgical Scissors	27
Nail Scissors	28 - 29
General Forceps	29 - 34
Tissue Forceps	35 - 36
Hollowware Instruments	37 - 39
Diamond Burr	39

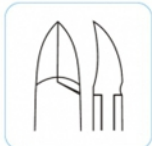

SS-1001
Nail Clipper Curved Jaw
14cm



SS-1002
Nail Clipper Lap-Joint
Curved 12 cm



SS-1003
Nail Clipper Barrel Spring
11.5cm



SS-1004
Nail Clipper Barrel Spring
13.5cm



SS-1005
Nail Nipper Half Head Cutter
14cm



Jaw Size 23mm

SS-1006
Nail Nipper 23mm Concave Jaw
14cm

NAIL CLIPPER



PODIATRY INSTRUMENTS



SS-1007
Nail Nipper 20mm Concave Jaw
14cm



SS-1008
Nail Clipper Angular Jaw
13.5cm



SS-1009
Nail Clipper Barrel Spring
11.5cm



SS-1010
Nail Clipper Fine Jaw
13.5cm

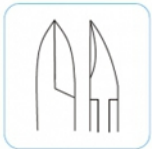

SS-1011
Ingrown Nail Clipper
13.5cm

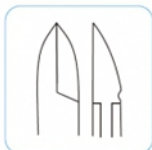

SS-1012
Nail Nipper Straight Jaw
14cm



SS-1013
Nail Extracting Forcep
13cm



SS-1020
Heavy Duty Nail Clipper
14cm



SS-1021
Heavy Duty Nail Clipper Straight
15cm



SS-1022
Heavy Duty Nail Clipper Curved
15cm

Nail Clippers with T.C ■■■

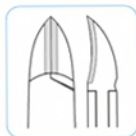

T.C



SS-1031
Nail Clipper Curved Jaw
14cm T.C

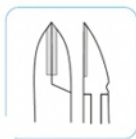

T.C



SS-1032
Nail Clipper Straight Jaw
14cm T.C

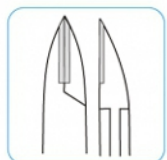

T.C



SS-1033
Nail Clipper Standard Jaw
13cm T.C



T.C

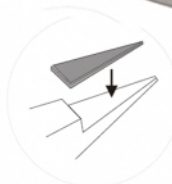

SS-1034
Nail Clipper Standard Jaw
11.5cm T.C

DOUBLE ACTION NAIL CLIPPER

PODIATRY INSTRUMENTS



SS-1041
Double Action Nail Clipper
Curved Double Spring
15cm



SS-1042
Nail Clipper Lap-Joint
Barrel Spring Curved 12 cm



SS-1043
Double Action Nail Clipper Curved
Barrel Spring 12cm

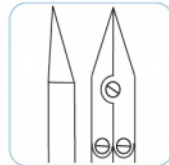

SS-1044
Nail Clipper Barrel Spring
15cm



SS-1045
Double Action Nail Splitter
Double Spring 15cm



SS-1046
Double Action Nail Clipper Straight
Jaw Double Spring 12cm



SS- 1047
Double Action Nail Clipper
Straight Barrel Spring 15cm



SS- 1048
Double Action Nail Clipper
Straight Double Spring 15cm



SS- 1049
Double Action Nail Clipper
Curved Double Spring 12cm



SS- 1050
Double Action Nail Clipper
Curved Barrel Spring 15cm



SS- 1051
Curved Double Action
Nail Clipper Extra Fine 15cm



SS- 1052
Double Action Nail Clipper
Curved Double Spring 15cm

INGROWN NAIL CLIPPERS

PODIATRY INSTRUMENTS



SS-1061
Ingrown Nail Clipper
Standard Jaw 11.5cm



SS-1062
Ingrown Nail Clipper
Curved 13cm



SS-1063
Ingrown Nail Clipper Curved
11.5cm

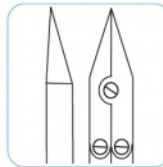

SS-1064
Ingrown Nail Splitter
15cm



SS-1065
Ingrown Nail Splitter
13cm



SS-1066
Ingrown Nail Splitter
13cm



SS-1067
Ingrown Nail Splitter
11.5cm

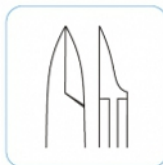

SS-1068
Ingrown Nail Clipper
Slim Jaw 15cm



SS-1069
Ingrown Nail Clipper
Slim Jaw 13cm



SS-1070
Ingrown Nail Clipper
Fine Jaw 15cm

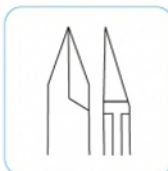

SS-1071
Ingrown Nail Clipper
Fine Jaw 15cm



INGROWN NAIL CLIPPERS

PODIATRY INSTRUMENTS



SS-1072
Ingrown Nail Clipper
Fine Jaw 13cm



SS-1073
Ingrown Nail Clipper
Fine Jaw 11.5cm



SS-1074
Ingrown Nail Clipper
Standard Jaw 15cm



SS-1075
Ingrown Nail Clipper
Standard Jaw 13cm

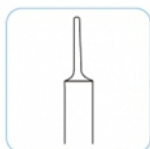

SS-1076
Thwaites Nail Splitter
13cm (used in PNA)



SS-1090
Cuticle Nipper
Scissor Type 10cm



SS-1091
Cuticle Nipper Box-joint
11mm Jaw 12cm



SS-1092
Cuticle Nipper Box-joint
9mm Jaw 12cm



SS-1093
Cuticle Nipper Box-joint 10mm Jaw
11.5cm

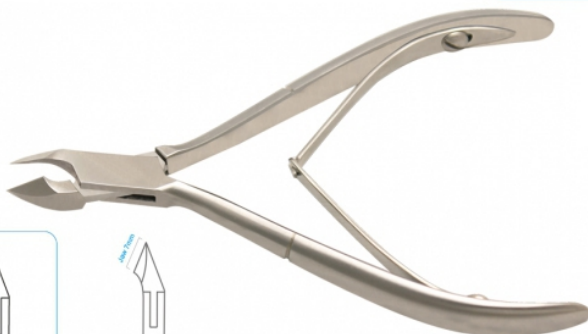

SS-1094
Cuticle Nipper Box-joint
7mm Jaw 11.5cm

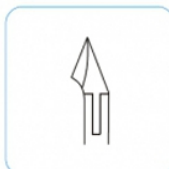

SS-1095
Cuticle Nipper Box-joint 9mm Jaw
10.5cm

TISSUE NIPPERS



PODIATRY INSTRUMENTS



SS-1096
Cuticle Nipper Box-joint
6mm Jaw 10.5cm



SS-1097
Cuticle Nipper Box-joint
15mm Jaw 13cm



SS-1098
Cuticle Nipper Box-joint
4mm Jaw 10.5cm



SS-1099
Cuticle Nipper Ingrown
Scissor Type 10cm



SS-1100
Cuticle Nipper Flat Jaw
Scissor Type 10cm

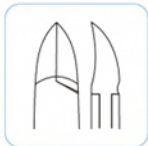

SS-1111
Nail Clipper Curved Jaw
14cm

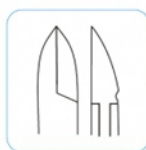

SS-1112
Nail Clipper Straight Jaw
14cm

■ ■ ■ Ingrown Nail Clippers G/Handle



SS-1121
Ingrown Nail Clipper
Standard Jaw
10.5cm

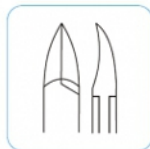

SS-1122
Ingrown Nail Clipper
Curved 13cm

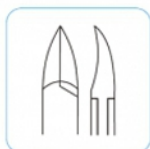

SS-1123
Ingrown Nail Clipper Curved
11.5cm

INGROWN NAIL CLIPPERS G/HANDLE

PODIATRY INSTRUMENTS



SS-1124
Ingrown Nail Splitter
15cm



SS-1125
Ingrown Nail Splitter
13cm



SS-1126
Ingrown Nail Splitter
11.5cm



SS-1127
Ingrown Nail Splitter
10.5cm



SS-1128
Ingrown Nail Clipper
Slim Jaw 15cm



SS-1129
Ingrown Nail Clipper
Slim Jaw 13cm



SS-1130
Ingrown Nail Clipper
Slim Jaw 11.5cm



SS-1131
Ingrown Nail Clipper
Slim Jaw 10.5cm



SS-1132
Ingrown Nail Clipper
Fine Jaw 15cm



SS-1133
Ingrown Nail Clipper
Fine Jaw 13cm

INGROWN NAIL CLIPPERS G/HANDLE

PODIATRY INSTRUMENTS



SS-1134
Ingrown Nail Clipper
Fine Jaw 10.5cm



SS-1135
Ingrown Nail Clipper
Standard Jaw 15cm



SS-1136
Ingrown Nail Clipper
Standard Jaw 13cm



SS-1137
Ingrown Nail Clipper
Standard Jaw 11.5cm



SS-1138
Ingrown Nail Nipper
Curved 15cm



SS-1151
Scalpel Handle
No 4



SS-1152
Beaver Handle Round for Microsurgery
Blade 61



SS-1153
Scalpel Handle
No 7



SS-1154
Scalpel Handle
No 3



SS-1155
Sterile Scalpel Handle
No 4, No 5 & No 6



SS-1156
Beaver Handle Aluminum fits
Size 61 blade

Probes



SS-1171
Probe eye
15cm



SS-1172
Sinus Probes
15cm



SS-1173
Gobsonhorne Probes
14cm

Blacks Nail Files Double Ended



SS-1181
Black Nail File STR&CVD Narrow
Tip 15cm



SS-1182
Nail File Med cut STR&CVD head
15cm



SS-1183
Nail Rasp backward cutting
16cm

BLACK NAIL FILES DOUBLE ENDED

PODIATRY INSTRUMENTS



SS-1184
Nail File Angled Course Large Head
16cm No exchange or refund



SS-1185
Black Nail File Dble Ended Large Square
Head Str 15cm



SS-1186
Black Nail File Fine cut Oval head
15cm



SS-1187
Nail File fine head & Excavator
15cm



SS-1188
Black Nail File Double Ended Square
15cm



SS-1189
Dble Ended Blacks Nail File and Probe
15cm Str

Blacks Nail Files Single Ended



SS-1201
Blacks Nail File Angled Head Fine Cut
14cm



SS-1202
Nail File Narrow Oval Head Fine Cut
14cm



SS-1203
Nail File Small Oval Head Fine Cut
14cm



SS-1204
Nail File Medium Oval Head Fine Cut
14cm



SS-1205
Nail File Large Oval Head Fine Cut
14cm



SS-1206
Nail File Large Head Coarse Cut
Angled 14cm



SS-1207
Nail File Medium Head Coarse Cut Angled
14cm



SS-1208
Nail File Medium Head Coarse Cut
14 cm



SS-1209
Nail File Str Small Head Coarse Cut
14cm



SS-1221
Bone File No.12 Double Ended,
7" (17.8cm), Plain Serrations



SS-1222
Callus Remover Plastic Handle
18cm



SS-1223
Callus Shaver Stainless Steel
12cm



SS-1224
Foot Rasp 4 sided flat and round
20cm



SS-1225
Foot Rasp 4 Side 1 Coarse &
3 Medium 15cm



SS-1226
Foot Rasp Double Sided
16cm



SS-1227
Riflor Angled Foot Rasps
20cm



SS-1228
Nail or Bone Rasp 6 3/4" (17.1cm)
double Ended Solid Octagon handle
angled inside and outside file



SS-1229
Bone File No.10, Double end
7" (17.8cm) Plain Serrations



SS-1230
Bone File No.12A Double Ended
7" (17.8cm), Cross Serrations



SS-1231
Foot Rasp Double Sided Fine & Coarse

DIAMOND DEB FOOT DRESSER

PODIATRY INSTRUMENTS



SS-1241
Diamond Deb Foot Dresser File
20cm



SS-1242
NDiamond Deb Foot Dresser File
15cm



SS-1243
Diamond Deb Foot Dresser Slim
15cm SINGLE USE



SS-1244
Diamond Deb Foot Dresser Slim
10cm SINGLE USE



SS-1245
Diamond Deb Foot Dresser Slim
20cm

Foreign Body Currettes



SS-1261
Gross Ear Hook and Spoon
13cm



SS-1262
Nail Elevator Flicking Single Sided
13cm



SS-1263
Nail Cleaner Single Sided Wide Handle
13cm



SS-1264
Nail Scope Excavator Single Sided
13cm



SS-1265
Fox Dermal Curette 6 mm dia
13cm



SS-1266
Fox Dermal Curette 4 mm dia
13cm



SS-1267
Fox Dermal Curette 2 mm dia
13cm



SS-1268
Langenbeck Curette Small
13cm



SS-1269
Langenbeck Curette Medium
13cm



SS-1270
Langenbeck Curette Large
13cm



SS-1271
Langenbeck curette with Hock
13cm



SS-1281
Nail Saalfeld Large Double Sided
13cm



SS-1282
Williger Volkman Currettes Medium
13cm



SS-1283
Williger Volkman Currettes Large
13cm

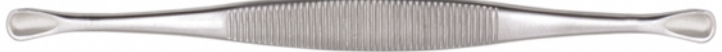

SS-1284
Volkman Currettes Double Ended Small
13cm

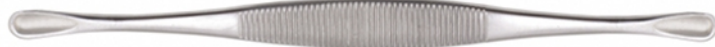

SS-1285
Volkman Currettes Double Ended Medium
13cm



SS-1286
Volkman Currettes Double Ended Large
13cm



SS-1287
Volkman Currettes Small Hole & Arrow
13cm



SS-1288
Volkman Currettes Medium Hole & Arrow
13cm



SS-1289
Volkman Currettes Large Hole & Arrow
13cm



SS-1290
Nail Saalfeld Small Double Sided
13cm



SS-1291
Nail Saalfeld Medium Double Sided
13cm



SS-1292
Williger Volkman Currettes Small
13cm



SS-1293
Nail Excavator Double Ended
13cm



SS-1294
Nail Excavator Round Edge D/Ended
13cm



SS-1295
Nail Excavator Round Edge &
Blacks File 13cm



SS-1296
Nail Excavator Round Edge with Knife
13cm

VOLKMANN NAIL CURETTES

PODIATRY INSTRUMENTS



SS-1297
Nail Excavator Straight 1mm &
2mm 13cm



SS-1298
Nail Curette Angled 2mm & 3mm
13cm



SS-1299
Nail Curette 2mm & 3mm Hole
13cm



SS-1300
Nail Excavator Spoon with Sharp
needle
13cm



SS-1301
Nail Clipper Barrel Spring
11.5cm

■ ■ Dura & Skin Retractor



SS-1311
Podiatry Wound Retractor
15cm 13X5mm



SS-1312
Skin Hook Retractor Sharp
Size 3



SS-1313
Small Dissecting Hock
17cm



SS-1314
Knapp Retractor 2 Sharp Prongs
13cm



SS-1315
Langenbeck Retractor 16x6mm
16cm



SS-1316
Penfield Double Slightly Curved
15cm



SS-1317
Knapp Retractor 4 Blunt prongs
13cm



SS-1318
Desmarres Lid Retractor
3,15 mm 14cm



SS-1319
Desmarres Lid Retractor
1, 11 mm 14cm



SS-1320
Mini-Homann Retractor
16cm Blade 6mm



SS-1321
Skin Hook Retractor Blunt
Size 3

Nail Scope Curettes ■■■



SS-1331
Nail Curette & Ingrown Cleaner
2mm 13cm



SS-1332
Medium Nail Curette with Knife
13cm



SS-1333
Angled Nail Curette with Knife
13cm



SS-1334
Nail Curette with Excavator
2mm Hole 13cm



SS-1335
Nail Curette with Flat Square Edge
13cm



SS-1336
Ingrown Toenail Cleaner
1mm & 2mm 13cm



SS-1337
Nail Curette with Pterygium Remover
13cm

■■■ Nail Spatulas



SS-1341
Nail Spatula D/Ended Blade
6mm 16cm



SS-1342
Nail Spatula 4mm Single Ended
13cm



SS-1343
Nail Spatula 6mm Single Ended
13cm



SS-1344
Nail Spatula with Flat Probe
15cm



SS-1345
Nail Spatula Blunt Probe & Packer
5mm wide 14cm



SS-1346
Nail Spatula Blunt Probe & Packer
7mm wide 14cm

NAIL SPATULAS



PODIATRY INSTRUMENTS



SS-1361
Nail elevator (Excavator with
2X25mm Packer Blunt Hock)



SS-1362
Nail Elevator 4mm Blade D/Ended
15cm



SS-1363
Nail Spatula Curved Blade
7mm 15cm



SS-1364
Nail Spatula with Nail Probe
14cm



SS-1365
Nail Spatula 2mm Single Ended
13cm

■ ■ ■ Nail Carvers



SS-1371
Nail Chisel Slightly Curved
3mm 16.5cm



SS-1372
Freer Septum Elevator Blade
5mm wide 16cm



SS-1373
Hurd Dissector & Pillar Retractor
9x25mm 18cm



SS-1374
Freer Nail Chisel 4mm Wide Curved
15cm



SS-1375
Nail Chisel Sharp Angled S/Sided
16.5cm



SS-1376
Nail Chisel Sharp Straight S/Sided
4mm 16.5cm

■ ■ ■ Nail Probes



SS-1381
Nail Probe Angled Flat fine Head
14cm



SS-1382
Nail Probe Angle Sharp Hock
14cm



SS-1383
Probe and Packer Blunt
14cm



SS-1384
Nail Probe Straight and Blunt
14cm



SS-1385
Nail Excavator Round Edge with Medium
size Knife 13cm



SS-1386
Nail Probe Straight Flat Head
14cm



SS-1387
Nail Probe Angled Flat fine Head
14cm



SS-1388
Nail Probe Blunt Single Ended
14cm



SS-1389
Nail Probe Flat Angled



SS-1390
Nail Probe Needle Single Ended
14cm



SS-1391
Nail Probe Angled Flat Head
14cm



SS-1392
Ingrown Nail Curette Sharp edge
14cm



SS-1393
Nail Probe Needle Single Ended
14cm



SS-1394
Nail Probe Angled Flat Head
14cm



SS-1395
Probe and Packer Blunt
14cm

PROFESSIONAL SURGICAL SCISSORS

PODIATRY INSTRUMENTS



SS-1401
Super Operating Scissors
Straight Sharp/Sharp 15cm



SS-1402
Super Metzenbaum Scissor Straight
18cm



SS-1403
Super Edge Iris Scissor
Angled 11.5cm

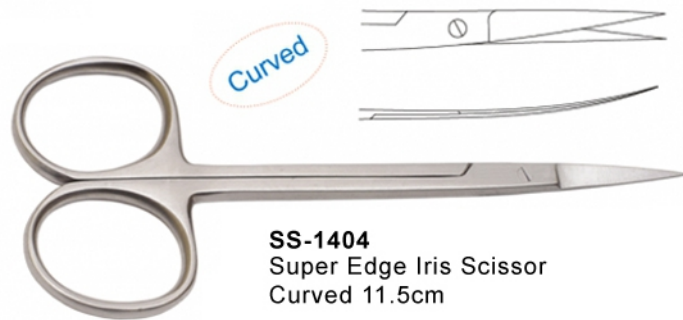

SS-1404
Super Edge Iris Scissor
Curved 11.5cm

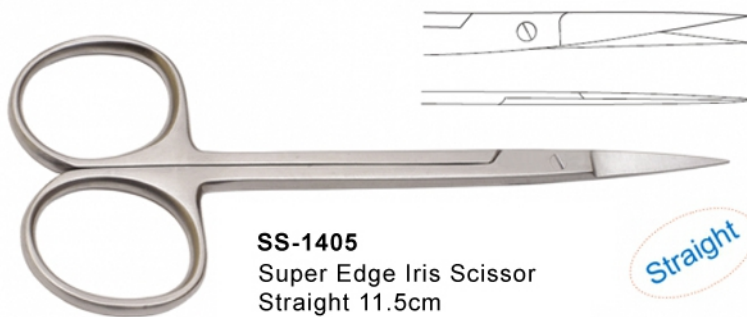

SS-1405
Super Edge Iris Scissor
Straight 11.5cm

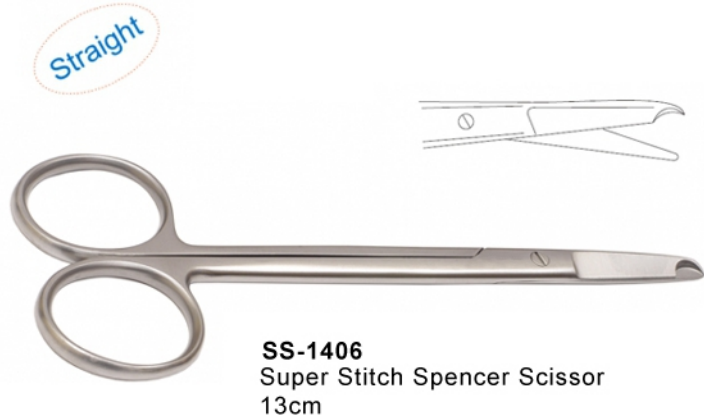

SS-1406
Super Stitch Spencer Scissor
13cm



SS-1407
Super Mayo Lexer Scissor
Curved 15cm



SS-1408
Super Mayo Lexer Scissor Straight
15cm



SS-1409
Super Metzenbaum Scissor Straight
14.5cm



SS-1410
Super Metzenbaum Scissor Straight
14.5cm

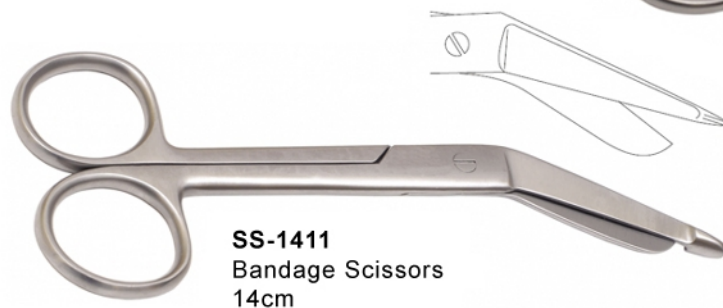

SS-1411
Bandage Scissors
14cm

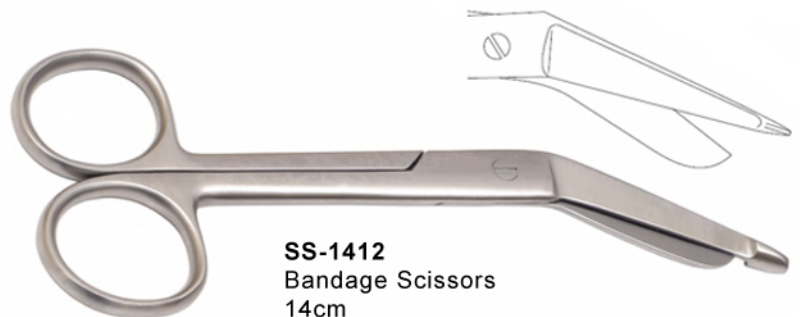

SS-1412
Bandage Scissors
14cm

PROFESSIONAL SURGICAL SCISSORS

PODIATRY INSTRUMENTS



SS-1413
Super Operating Scissors
Curved Blunt/Blunt 15cm

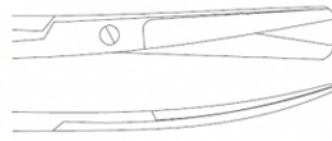

SS-1414
Super Operating Scissors Straight
Blunt/Blunt 15cm

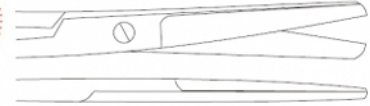

SS-1415
Super Operating Scissors Curved
Sharp/Blunt 15cm

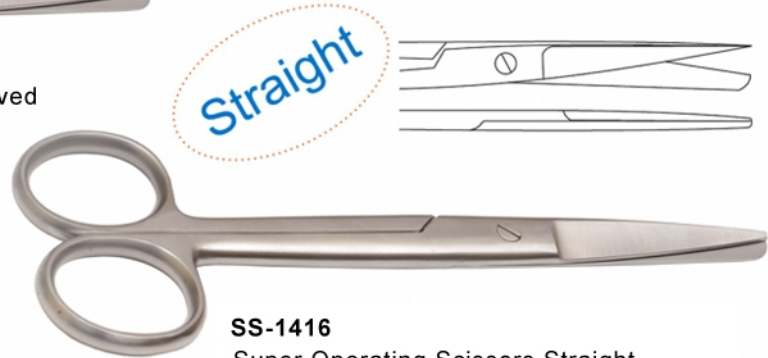
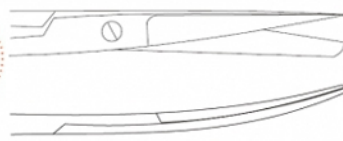

SS-1416
Super Operating Scissors Straight
Sharp/Blunt 15cm

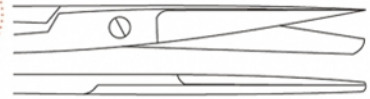

SS-1417
Super Operating Scissors Curved
Sharp/Sharp 15cm

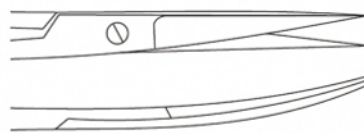

SS-1418
Super Metzenbaum Scissor
Curved 18cm

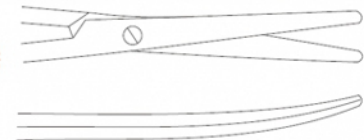



SS-1431
Double Action Nail Clipper
Curved Double Spring
15cm



SS-1432
Operating Scissors 14.5cm
Curved Blunt/Blunt

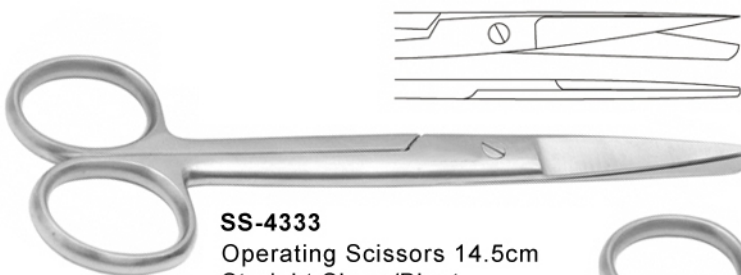

SS-4333
Operating Scissors 14.5cm
Straight Sharp/Blunt

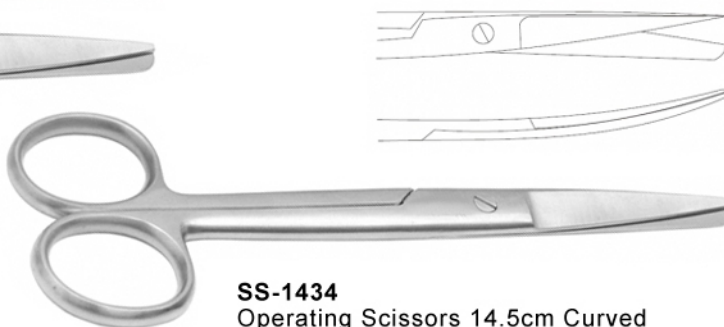

SS-1434
Operating Scissors 14.5cm Curved
Sharp/Blunt

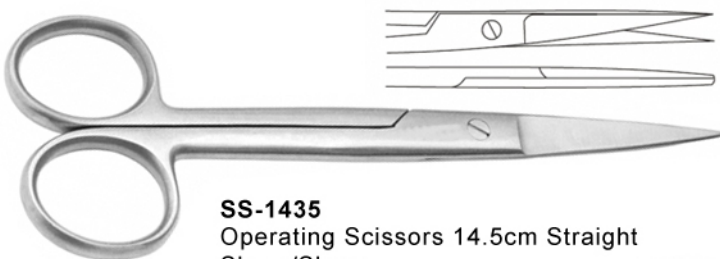

SS-1435
Operating Scissors 14.5cm Straight
Sharp/Sharp



SS-1436
Operating Scissors 14.5cm Curved
Sharp/Sharp

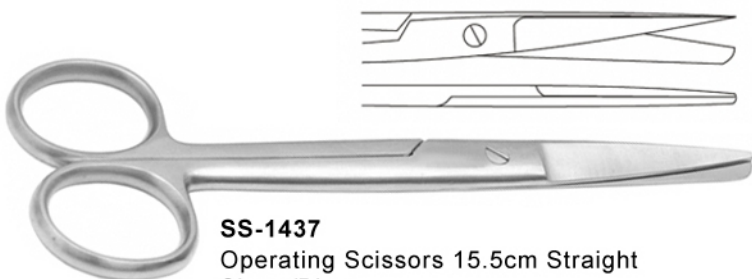

SS-1437
Operating Scissors 15.5cm Straight
Sharp/Blunt

NAIL SCISSORS



PODIATRY INSTRUMENTS



SS-1441
Standard Nail Scissor
10cm



SS-1442
Narrow Dissecting Scissor
11.5cm



SS-1443
Dissecting Scissor
11.5cm



SS-1444
Nail Scissor Curved
11.5cm



SS-1445
Fine Scissor Long Blade
10cm



SS-1446
Ligature Scissor
10cm



SS-1447
Micro Pointed Scissor
10cm Curved



SS-1448
Nail Arrow Pointed Scissor
10cm



SS-1449
Toe Nail Scissor
10cm



SS-1450
Micro Sharp Scissor
Spring Action 11.5cm

General Forceps ■■■



SS-1461
Mosquito Forceps STR
12.5cm



SS-1462
Mathieu Needle Holder with T.C
14cm

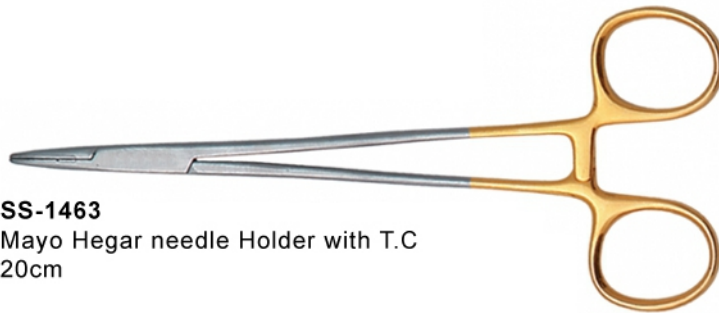

SS-1463
Mayo Hegar needle Holder with T.C
20cm

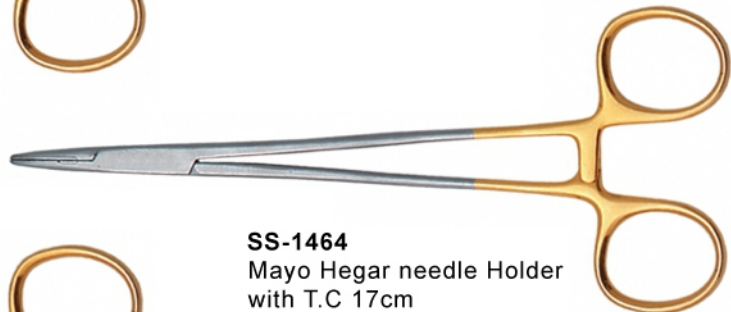

SS-1464
Mayo Hegar needle Holder
with T.C 17cm

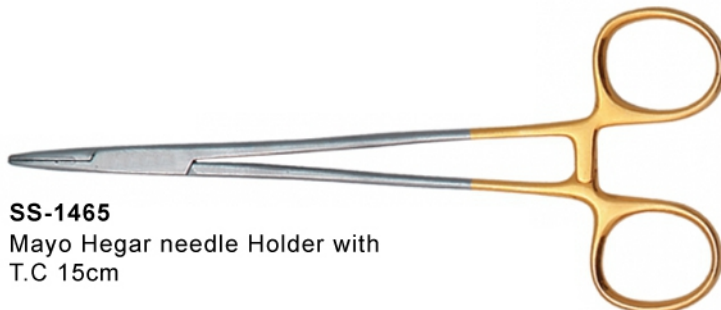

SS-1465
Mayo Hegar needle Holder with
T.C 15cm

GENERAL FORCEPS



PODIATRY INSTRUMENTS



SS-1466
Ryder Needle Holder with
T.C 17cm

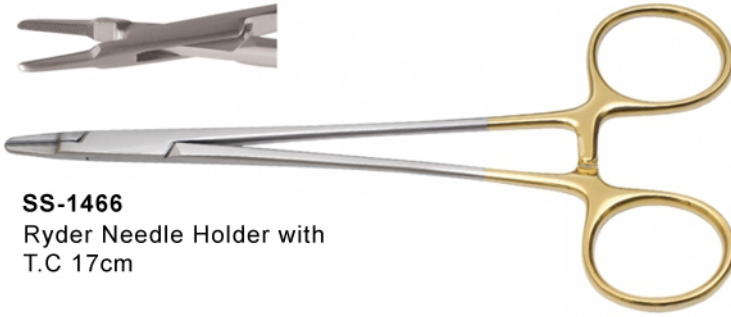

SS-1467
Ryder Needle Holder with
T.C 15cm



SS-1468
Ryder Needle Holder with
T.C 13cm

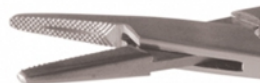
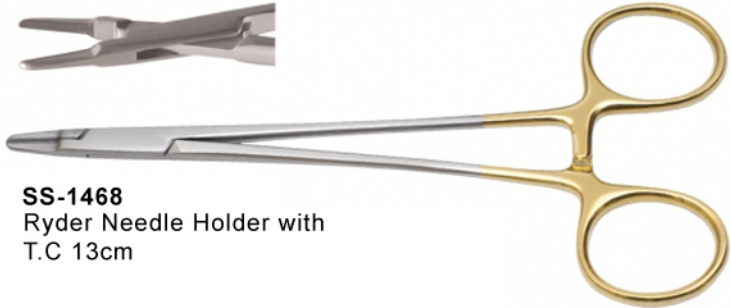

SS-1469
Needle Holder Forceps
16.5cm



SS-1470
Needle Holder Forceps
14cm



Curved

SS-1471
Mosquito Forceps CVD
12.5cm



Straight

SS-1472
Kelly Forceps STR
14cm



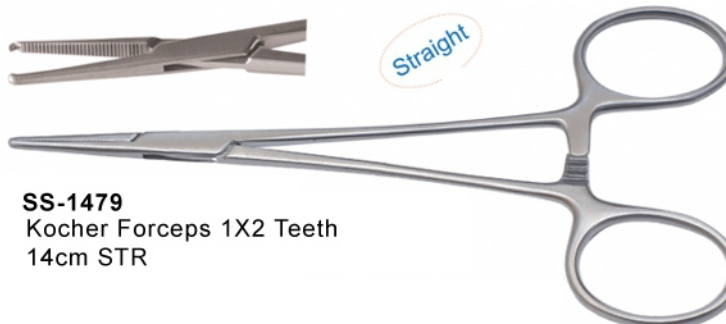
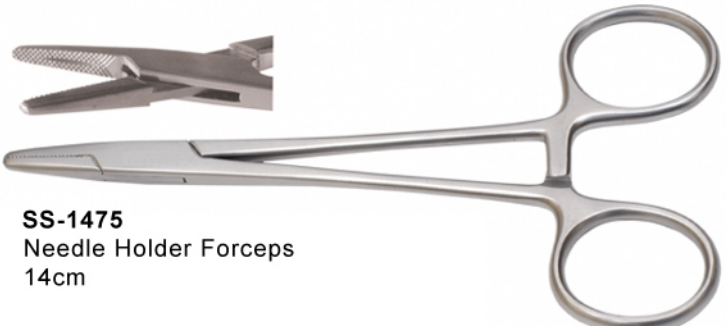
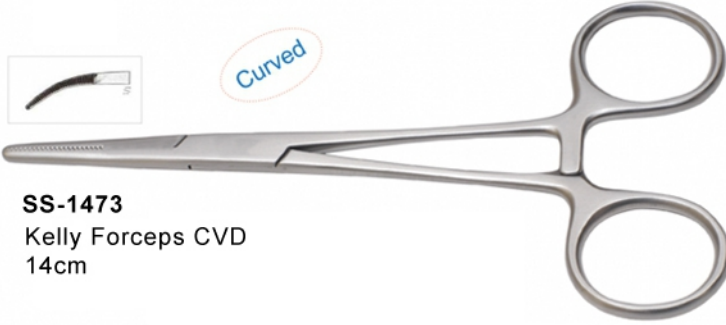

GENERAL FORCEPS



PODIATRY INSTRUMENTS



Curved



SS-1480
Kocher Forceps 1X2
Teeth 14cm CVD

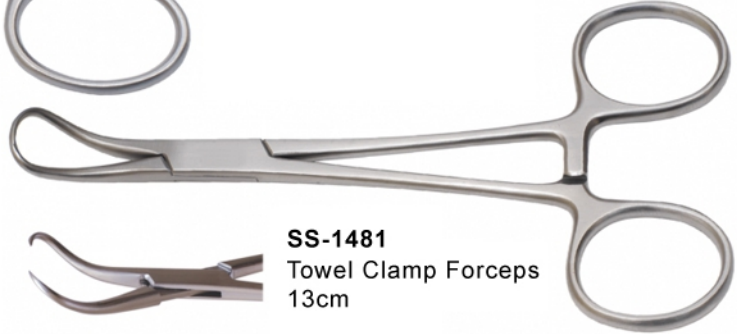

SS-1481
Towel Clamp Forceps
13cm



SS-1482
Needle Holder Forceps
12.5cm



Straight



SS-1484
Mathieu Needle Holder with
T.C 17cm



SS-1483
Mosquito Forceps
STR 9cm



Curved

SS-1485
Mosquito Forceps
CVD 9cm



SS-1486
Olsen Hegar Needle Holder with
TC 13cm

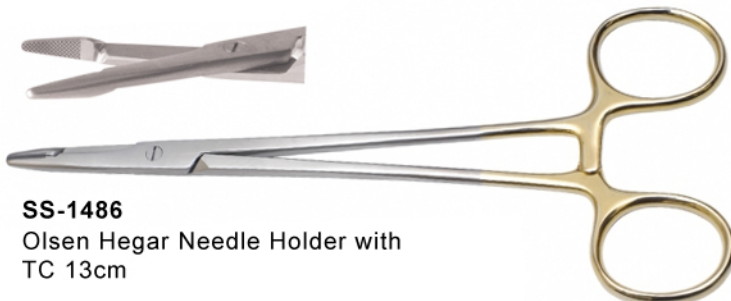



SS-1487
Kocher Forceps 1X2 Teeth
14cm CVD

Curved



SS-1488
Towel Clamp Forceps
13cm



SS-1489
Needle Holder Forceps
12.5cm



Straight



SS-1490
Mosquito Forceps
STR 9cm



SS-1491
Mathieu Needle Holder with
T.C 17cm



SS-1492
Roberts Artery Forceps Curved
20cm



SS-1493
Roberts Artery Forceps Straight
16cm



SS-1494
Roberts Artery Forceps Straight
17cm

GENERAL FORCEPS



PODIATRY INSTRUMENTS



SS-1495
Roberts Artery Forceps Straight
20cm



SS-1496
Spanch Dressing Forceps
18cm



SS-1497
Spanch Dressing Forceps
25cm



SS-1498
Dressing Forceps
17.5cm



SS-1499
Dressing Forceps
25cm



SS-1500
Rampley Forceps
17cm



SS-1501
Rampley Forceps
24cm



SS-1502
Kocher Forceps Straight
17cm

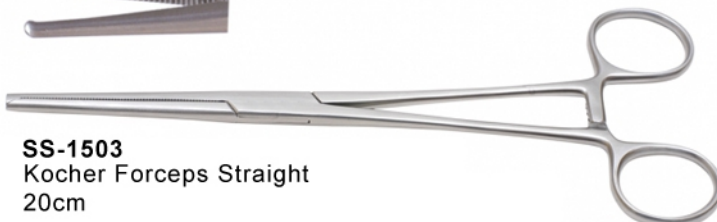

SS-1503
Kocher Forceps Straight
20cm



SS-1511
Dressing Tissue Forceps
13cm Straight



SS-1512
Dressing Fine Tissue Forceps
STR 11.5cm



SS-1513
Dressing Fine Tissue Forceps
STR 13cm



SS-1514
Dressing Fine Tissue Forceps
STR 15cm



SS-1515
Donney Tissue Forcep
1X2 Teeth 18cm



SS-1516
Waugh Dressing forceps
13cm



SS-1517
Waugh Dressing forceps
15cm



SS-1518
Waugh Dressing forceps 18cm



SS-1519
Mcindoe Tissue Forceps
15cm



SS-1520
Dissecting waugh Tissue Forceps
13cm



SS-1521
Dissecting waugh Tissue Forceps
15cm



SS-1522
Dressing Splinter Forceps
10cm



SS-1523
Dressing Splinter Forceps
11.5cm



SS-1524
Dissecting Fine Tissue Forcep Crvd
11.5cm



SS-1525
Meriam Tweezers
16cm



SS-1526
Dressing Tissue Forceps
14cm Straight

TISSUE FORCEPS



PODIATRY INSTRUMENTS



SS-1527
Dressing Tissue Forceps
15cm Straight



SS-1528
Adson Tissue Forceps
12cm



SS-1529
Adson Tissue Forceps
14cm



SS-1530
Adson Tissue Forceps 1X2 Teeth
12cm



SS-1531
Adson Tissue Forceps 1X2 Teeth
14cm



SS-1532
Dressing forceps 1X2 Teeth
13cm



SS-1534
Dressing forceps 1X2 Teeth
14cm



SS-1535
Dressing forceps 1X2 Teeth
15cm



SS-1536
Lane Tissue Forceps 1X2 Teeth
14cm



SS-1537
Lane Tissue Forceps 1X2 Teeth
17cm



SS-1538
Carmalt Splinter Tissue Forceps
11.5cm



SS-1539
Dressing Splinter Forceps
13cm



SS-1551
Instruments Box
Size: MM200X100X60H



SS-1552
Instrument Sterilization
Tray with lid 10X8X2.5"



SS-1553
Instrument Sterilization Tray with lid
Size: 8X6X2"



SS-1554
Instrument Sterilization Tray with lid
Size: 10X4X2"



SS-1555
Kidney Bowl 280mm.
ML 1000



SS-1556
Kidney Bowl 250mm.
ML 550

HOLLOWARE INSTRUMENTS

PODIATRY INSTRUMENTS



SS-1558
Kidney Bowl 200mm.
ML 400



SS-1559
Kidney Bowl 160mm.
ML 100



SS-1560
Kidney Bowl 280mm.
ML 1000



SS-1561
Kidney Bowl 250mm.
ML 550



SS-1562
Kidney Bowl 200mm.
ML 400



SS-1563
Kidney Bowl 160mm.
ML 100



SS-1564
Instruments Box
MM400X200X70H



SS-1565
Instruments Box
MM300X150X60H



SS-1566
Instrument Sterilization
Tray with lid 14X12X3"



Diamond Burr (Single Use Only) ■■■



SS-1571
Medium Flame Shape
Diamond Burr



SS-1572
Small Flame Shape
Diamond Burr



SS-1573
Large Flame Shape
Diamond Burr



Add: Soulach Park, Kashmir Road,
Pacca Garha, Sialkot - 51310,
Pakistan.Tel: 0092-52-4352070
Whatsapp: 0092-344-6481581
Email: info@surgi-skill.com
Email: surgiskill2026@gmail.com